

Cores - Fios / Colores - Alambres / Wires - Colors

BLK = Preto Negro / Black	BRN = Marrom Marrón / Brown	BLU = Azul Azul / Blue	GRA = Cinza Gris / Gray	GRN = Verde Verde / Green	ORN = Laranja Naranja / Orange	PNK = Rosa Rosa / Pink	PPL = Violeta Violeta / Purple	RED = Vermelho Rojo / Red	TAN = Bege Beige / Tan	WHT = Branco Blanco / White	YEL = Amarelo Amarillo / Yellow	LT = Claro Claro / Light	DK = Escuro Oscuro / Dark
------------------------------	--------------------------------	---------------------------	----------------------------	------------------------------	-----------------------------------	---------------------------	-----------------------------------	------------------------------	---------------------------	--------------------------------	------------------------------------	-----------------------------	------------------------------

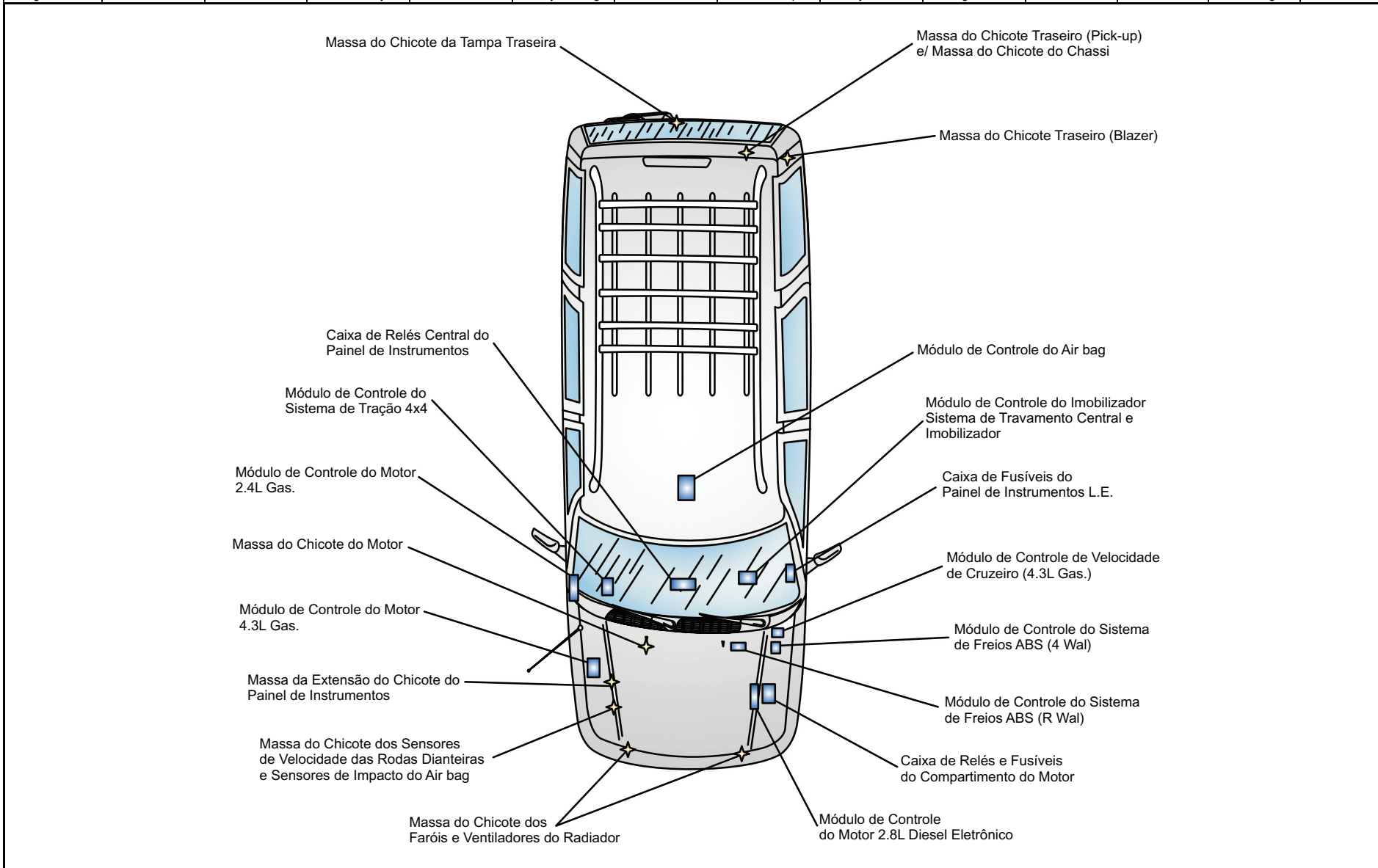

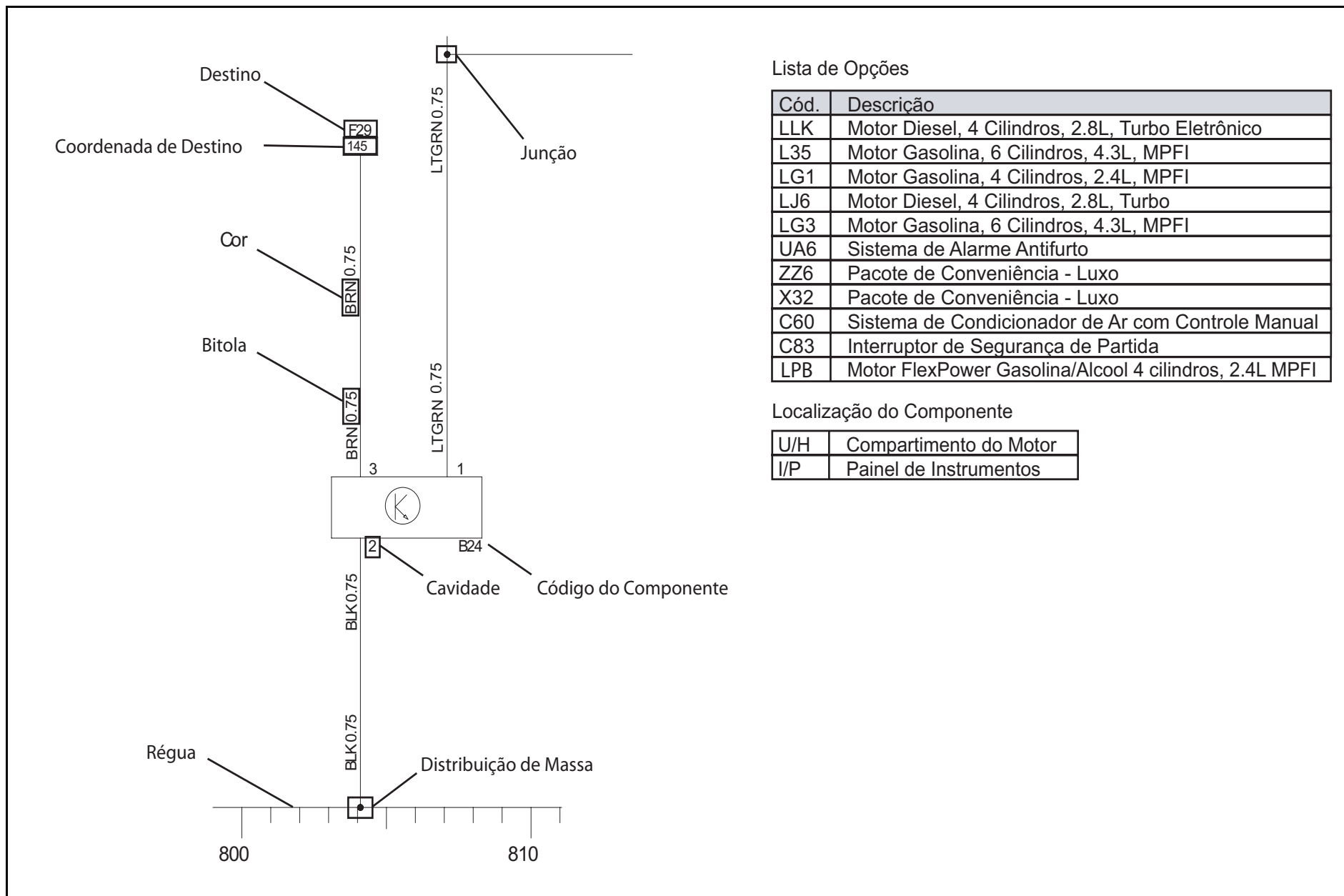

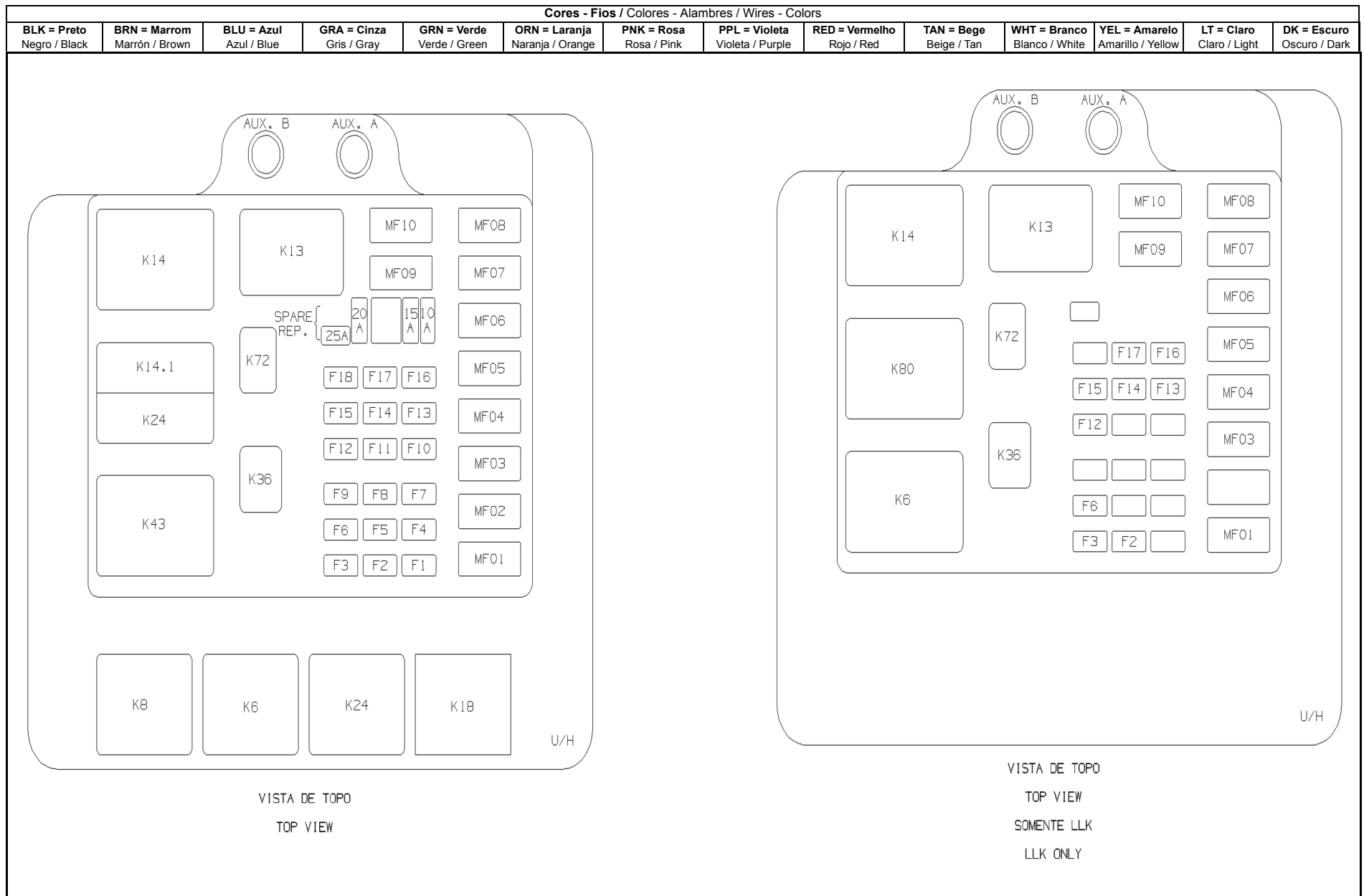

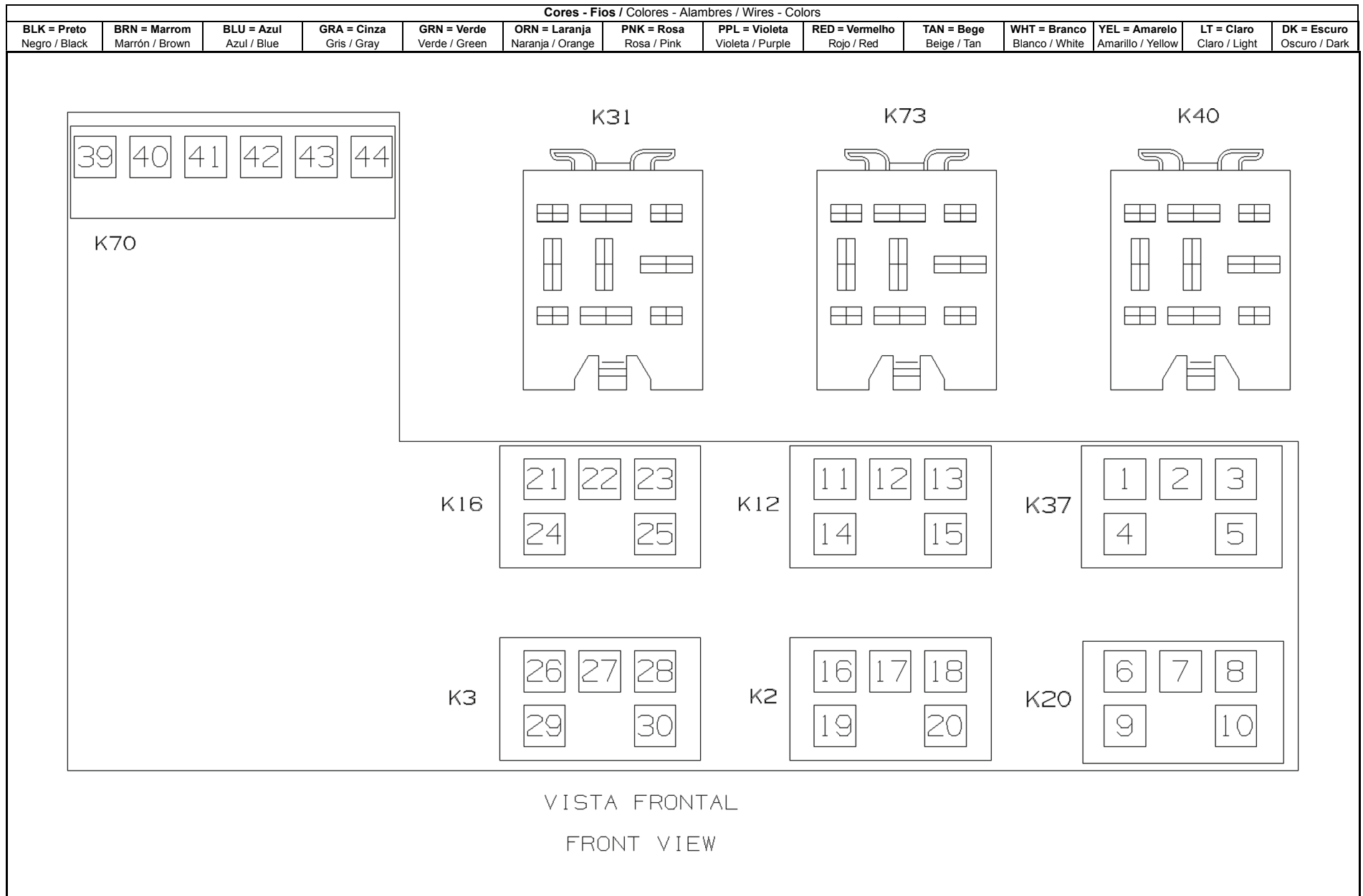

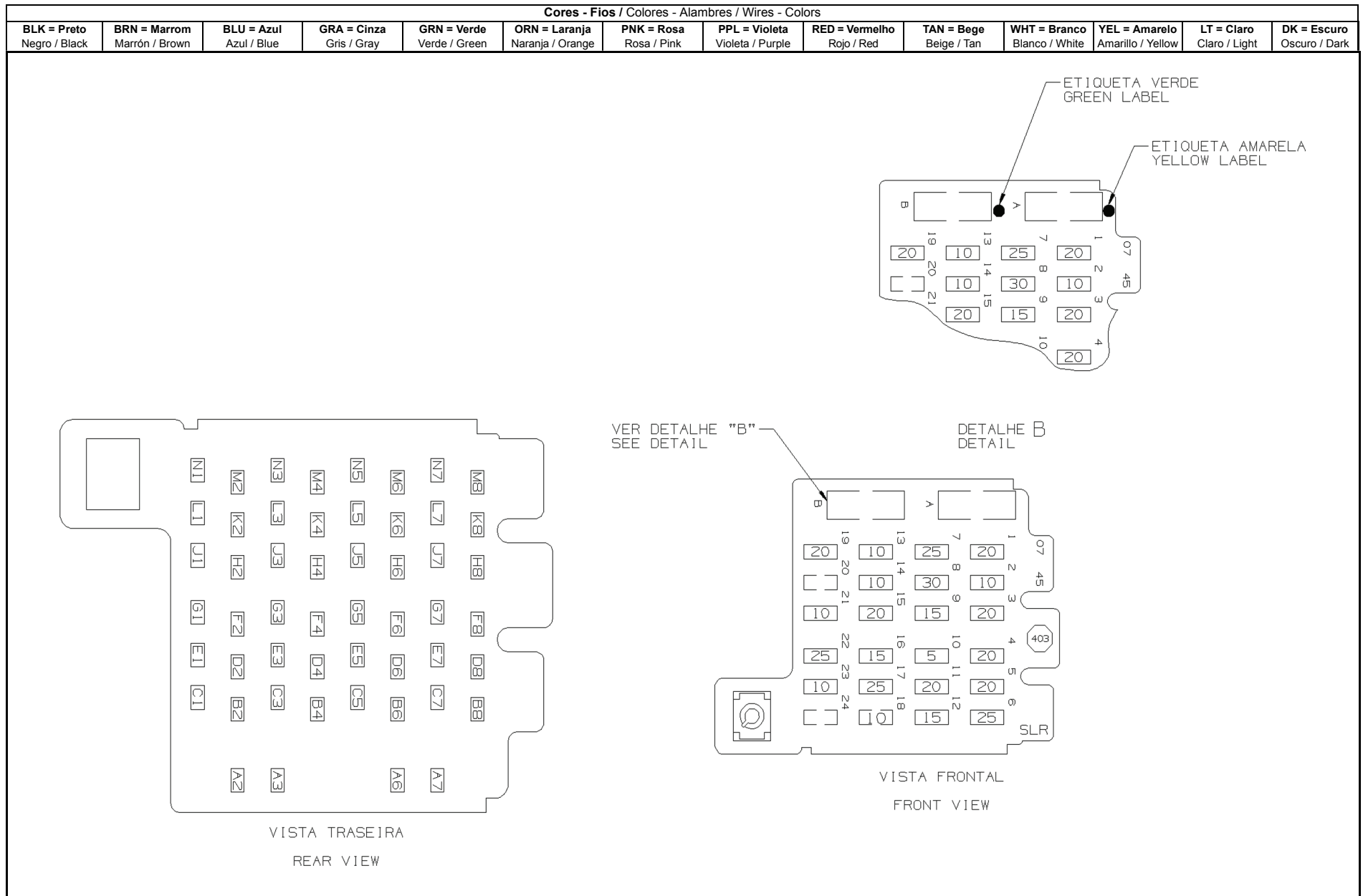

Cores - Fios / Colores - Alambres / Wires - Colors

BLK = Preto Negro / Black	BRN = Marrom Marrón / Brown	BLU = Azul Azul / Blue	GRA = Cinza Gris / Gray	GRN = Verde Verde / Green	ORN = Laranja Naranja / Orange	PNK = Rosa Rosa / Pink	PPL = Violeta Violeta / Purple	RED = Vermelho Rojo / Red	TAN = Bege Beige / Tan	WHT = Branco Blanco / White	YEL = Amarelo Amarillo / Yellow	LT = Claro Claro / Light	DK = Escuro Oscuro / Dark
------------------------------	--------------------------------	---------------------------	----------------------------	------------------------------	-----------------------------------	---------------------------	-----------------------------------	------------------------------	---------------------------	--------------------------------	------------------------------------	-----------------------------	------------------------------

CIRCUIT	DESCRIPTION
1	
2	1807 ABS 4WAL MODULE PIN B6
3	1801 IMMOBILIZER MODULE PIN 8
4	150 GROUNDING
5	151 GROUNDING
6	448 ECM MODULE PIN 13
7	481 ECM MODULE PIN 55
8	483 CLUSTER PIN 9 / ATWS MODULE PIN 21/28
9	800 AIR BAG MODULE PIN 5
10	
11	
12	696 ABS RWAL MODULE PIN D/DRAC PIN 10
13	
14	
15	
16	840 FUSE 7 (25 A)

CORES-FIOS WIRES-COLORS		
BLK	BLACK	PRETO
BRN	BROWN	MARRON
BLU	BLUE	AZUL
GRA	GRAY	CINZA
GRN	GREEN	VERDE
ORN	ORANGE	LARANJA
PNK	PINK	ROSA
PPL	PURPLE	VIOLETA
RED	RED	VERMELHO
TAN	TAN	BEGE
WHT	WHITE	BRANCO
YEL	YELLOW	AMARELO
LT	LIGHT	CLARO
DK	DARK	ESCURO

LP8

CIRCUIT	DESCRIPTION
1	
2	1807C ABS 4WAL MODULE PIN B6
3	
4	150N GROUNDING
5	151J GROUNDING
6	
7	11481 IMMOBILIZER MODULE PIN 6
8	483 CLUSTER PIN 9/ATWS MODULE PIN 21/28
9	800G AIR BAG MODULE PIN 5
10	
11	
12	696B ABS RWAL MODULE PIN D/DRAC PIN 10
13	
14	
15	
16	840 FUSE 7 (25A)

LG3

CIRCUIT	DESCRIPTION
1	
2	1807/799 ABS 4WAL MODULE PIN B6 / IMMOBILIZER MODULE PIN 7 / PCM PIN 5 J1-58 & J1-59
3	1801 IMMOBILIZER MODULE PIN 8
4	150 GROUNDING
5	151 GROUNDING
6	
7	
8	483 CLUSTER PIN 9 / ATWS MODULE PIN 21/28
9	800 AIR BAG MODULE PIN 5
10	
11	
12	696 ABS RWAL MODULE PIN D/ABS 4WAL MODULE PIN B1/ PCM PIN J2-49
13	1588 4X4 MODULE PIN D3
14	
15	
16	840 FUSE 7 (25 A)

LLK

CIRCUIT	DESCRIPTION
1	
2	1807 ABS 4WAL MODULE PIN B6
3	1801 IMMOBILIZER MODULE PIN 8
4	150 GROUNDING
5	151 GROUNDING
6	
7	448 ECM MODULE PIN K25
8	483 CLUSTER PIN 9 / ATWS MODULE PIN 21/28
9	800 AIR BAG MODULE PIN 5
10	
11	
12	696 ABS RWAL MODULE PIN D/DRAC PIN 10
13	1588 4X4 MODULE PIN D3
14	
15	
16	840 FUSE 7 (25 A)

LG1 - MOTOR 2.4L GAS. MPFI
 LLK - MOTOR 2.8L DIESEL
 LG3 - MOTOR 4.3L GAS
 LP8 - MOTOR 2.4L FLEX FUEL

 LG1 - ENGINE 2.4L GAS. MPFI
 LLK - ENGINE 2.8L DIESEL
 LG3 - ENGINE 4.3L GAS
 LP8 - ENGINE 2.4L FLEX FUEL



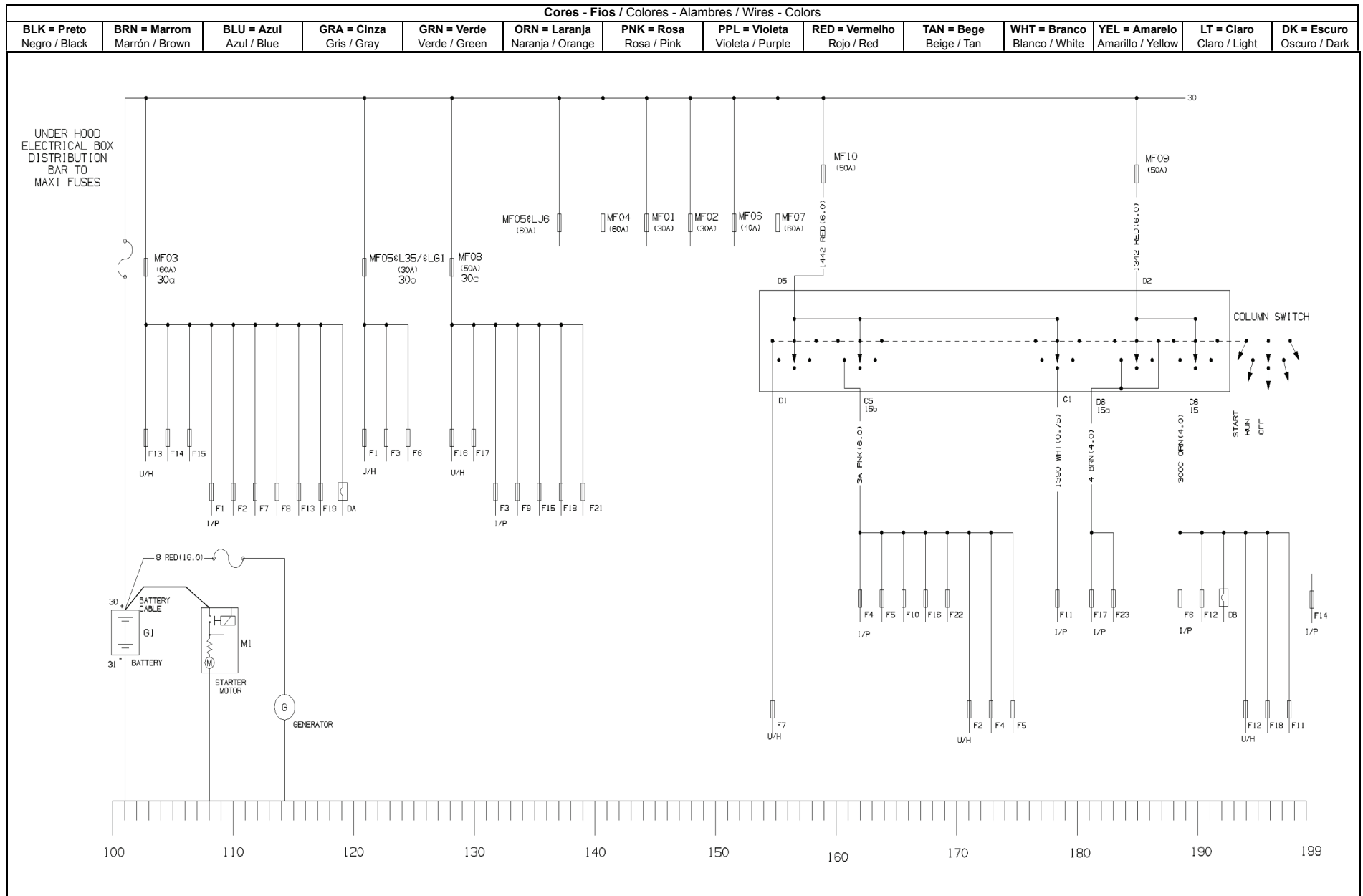

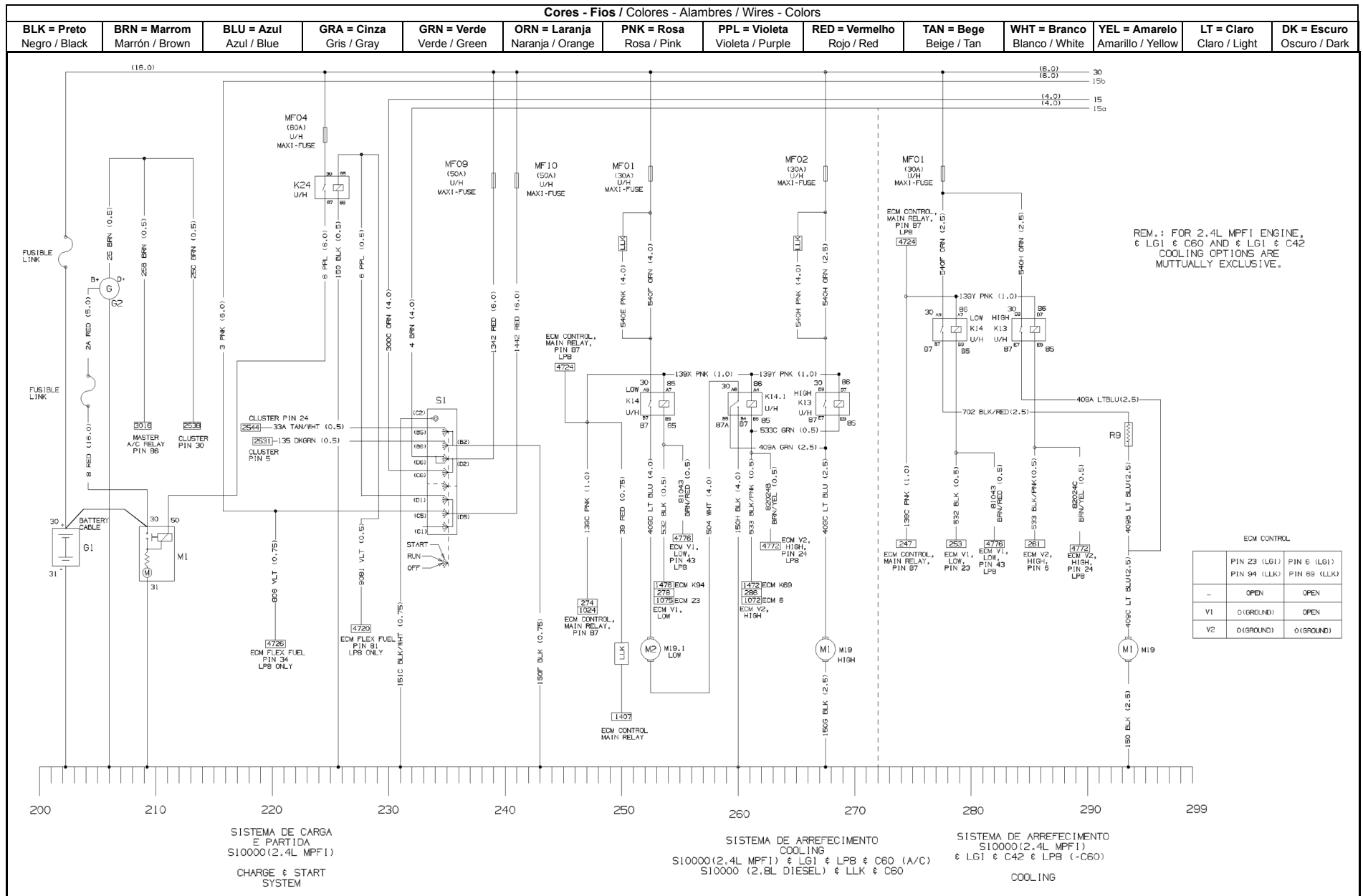

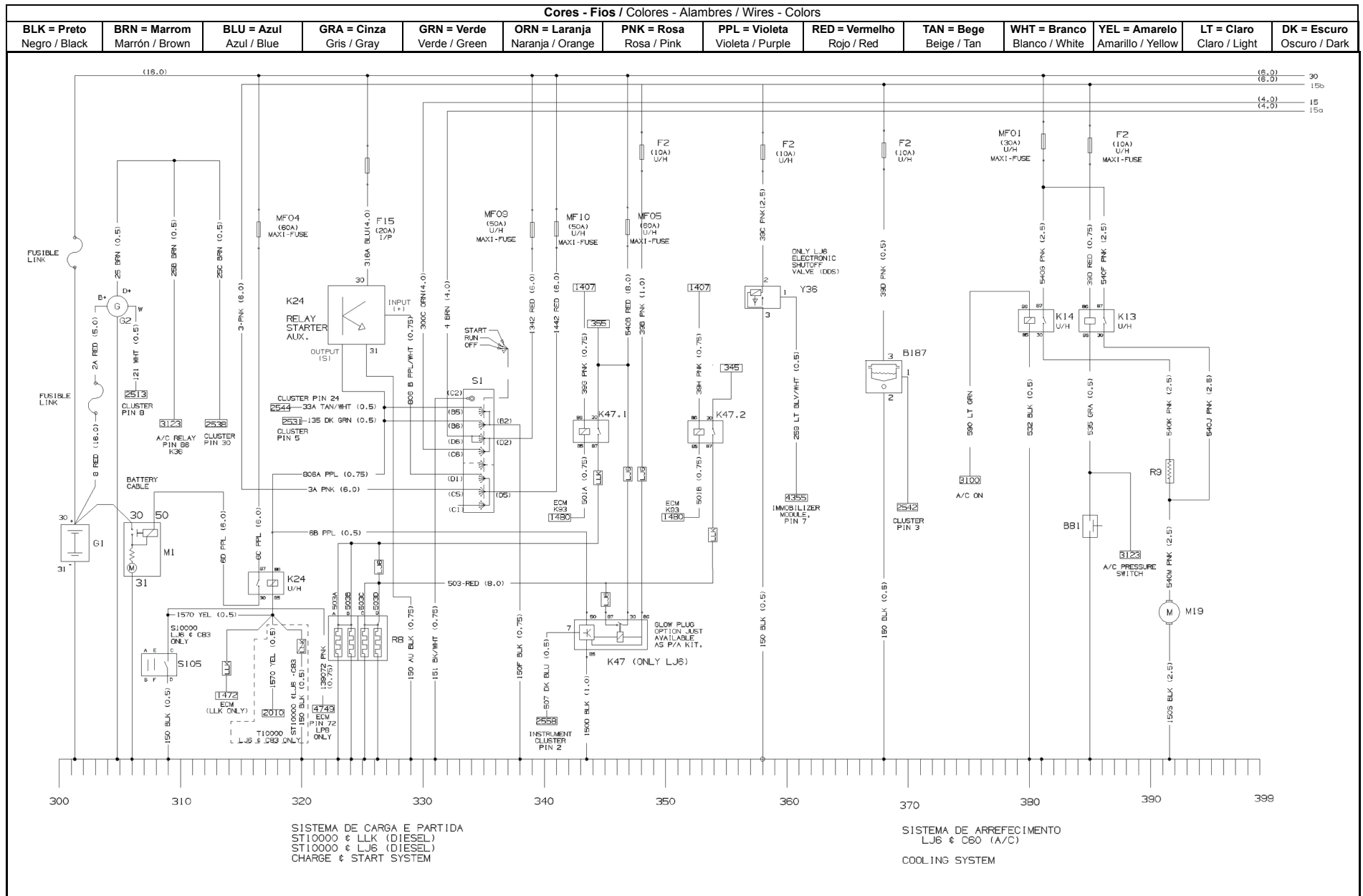

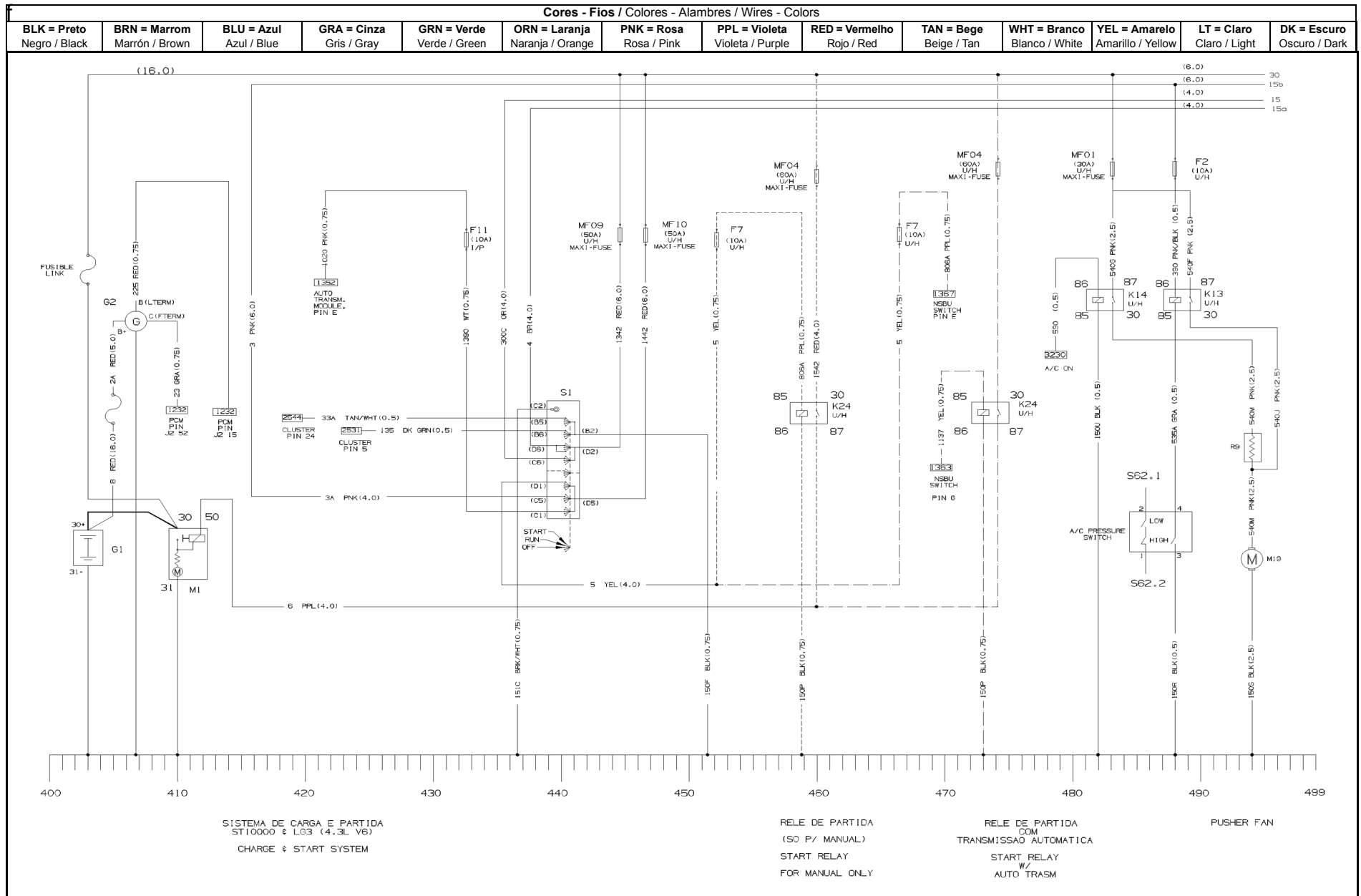

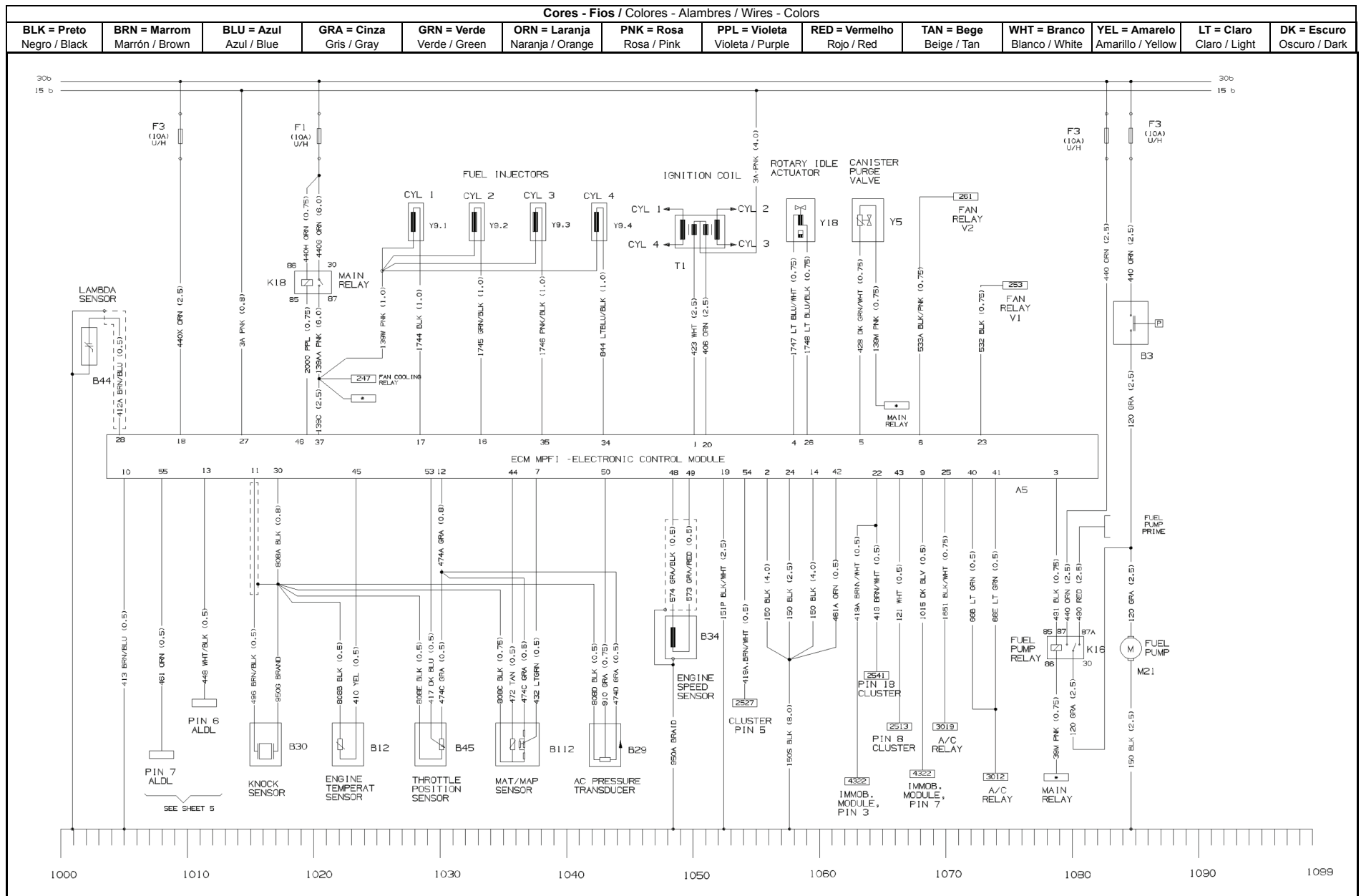

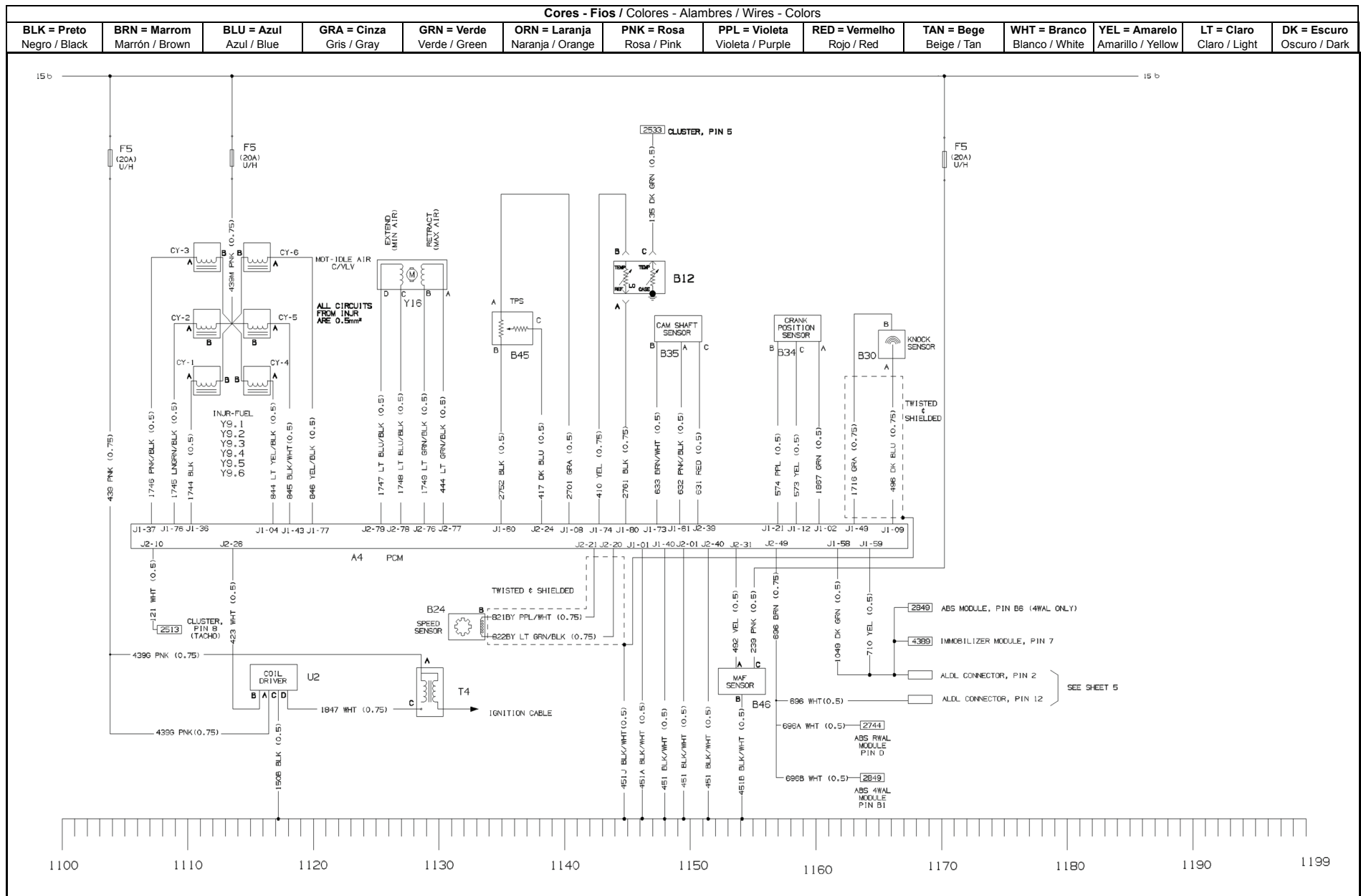

Cores - Fios / Cores - Alambres / Wires - Colors

BLK = Preto Negro / Black	BRN = Marrom Marrón / Brown	BLU = Azul Azul / Blue	GRA = Cinza Gris / Gray	GRN = Verde Verde / Green	ORN = Laranja Naranja / Orange	PNK = Rosa Rosa / Pink	PPL = Violeta Violeta / Purple	RED = Vermelho Rojo / Red	TAN = Bege Beige / Tan	WHT = Branco Blanco / White	YEL = Amarelo Amarillo / Yellow	LT = Claro Claro / Light	DK = Escuro Oscuro / Dark
-------------------------------------	---------------------------------------	----------------------------------	-----------------------------------	-------------------------------------	--	----------------------------------	--	-------------------------------------	----------------------------------	---------------------------------------	---	------------------------------------	-------------------------------------

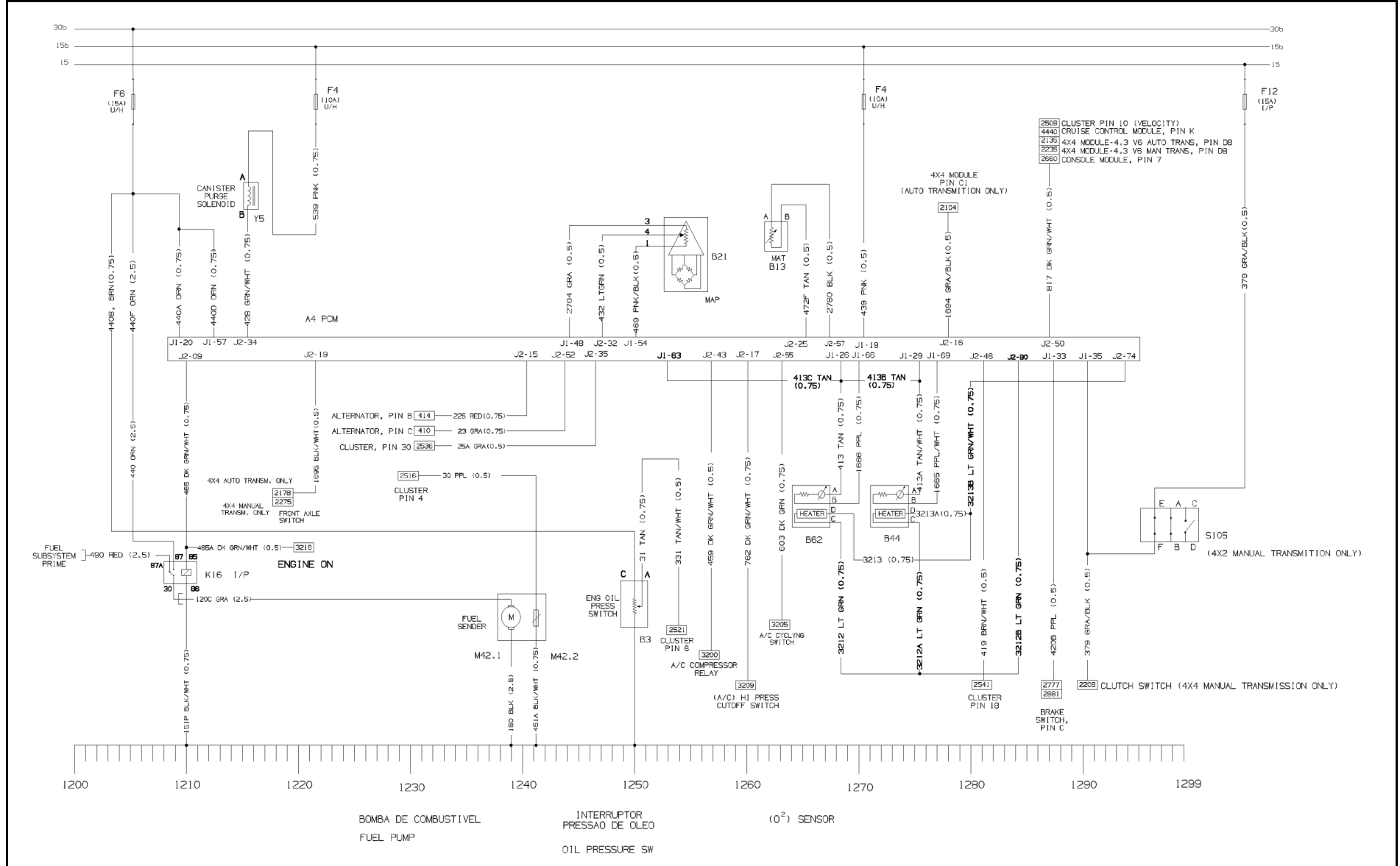

Cores - Fios / Colores - Alambres / Wires - Colors

BLK = Preto Negro / Black	BRN = Marrom Marrón / Brown	BLU = Azul Azul / Blue	GRA = Cinza Gris / Gray	GRN = Verde Verde / Green	ORN = Laranja Naranja / Orange	PNK = Rosa Rosa / Pink	PPL = Violeta Violeta / Purple	RED = Vermelho Rojo / Red	TAN = Bege Beige / Tan	WHT = Branco Blanco / White	YEL = Amarelo Amarillo / Yellow	LT = Claro Claro / Light	DK = Escuro Oscuro / Dark
------------------------------	--------------------------------	---------------------------	----------------------------	------------------------------	-----------------------------------	---------------------------	-----------------------------------	------------------------------	---------------------------	--------------------------------	------------------------------------	-----------------------------	------------------------------

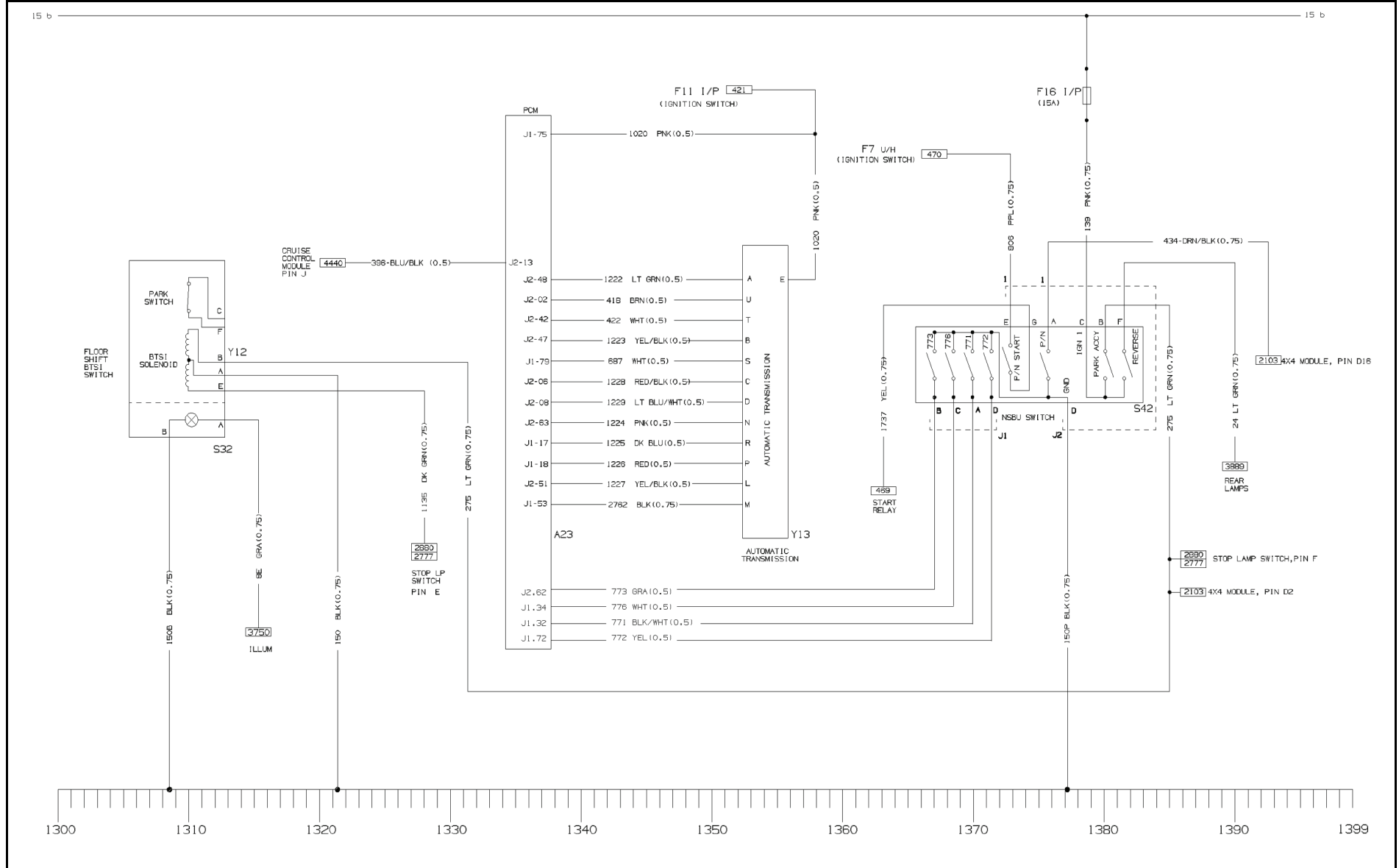

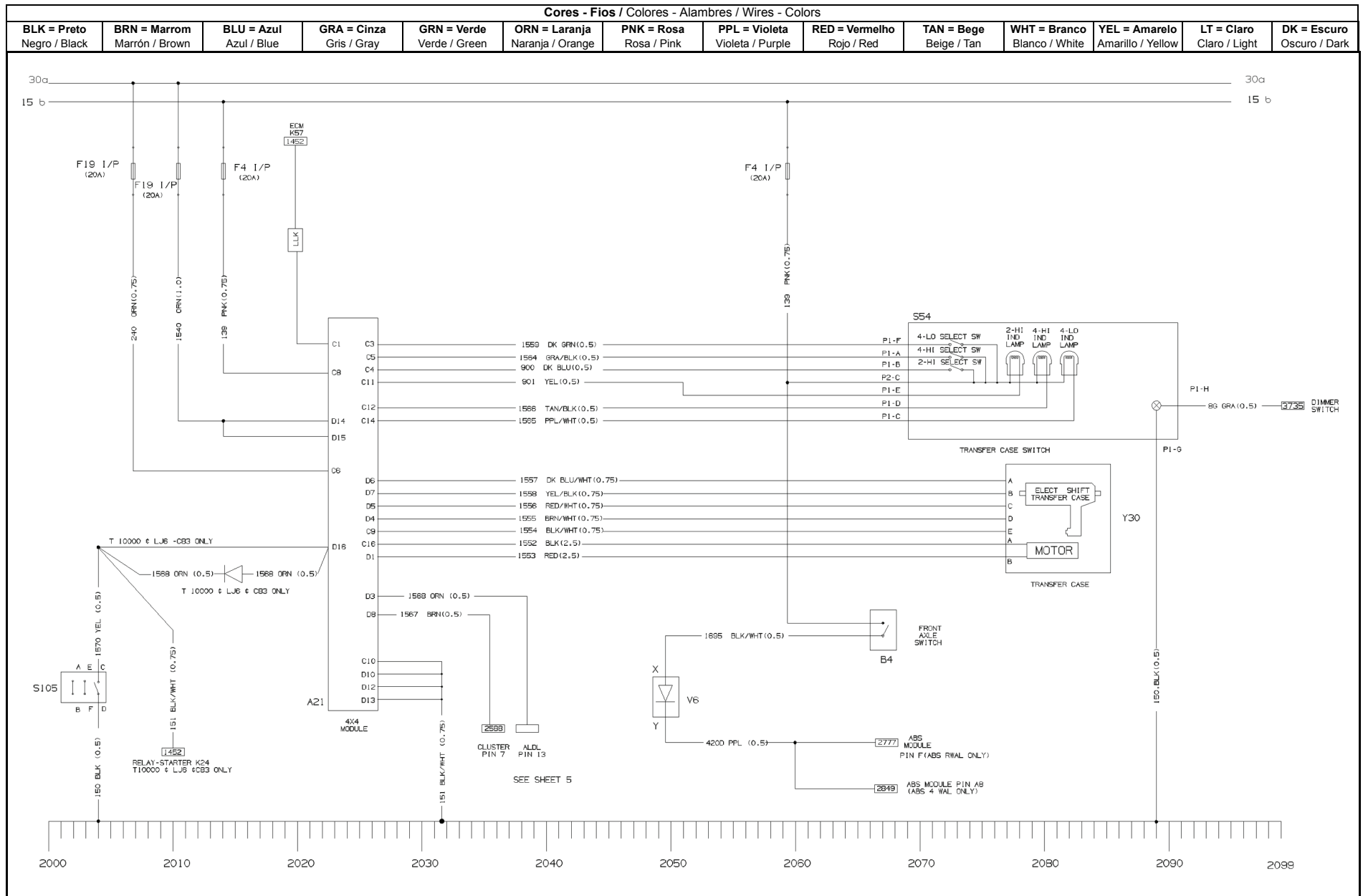

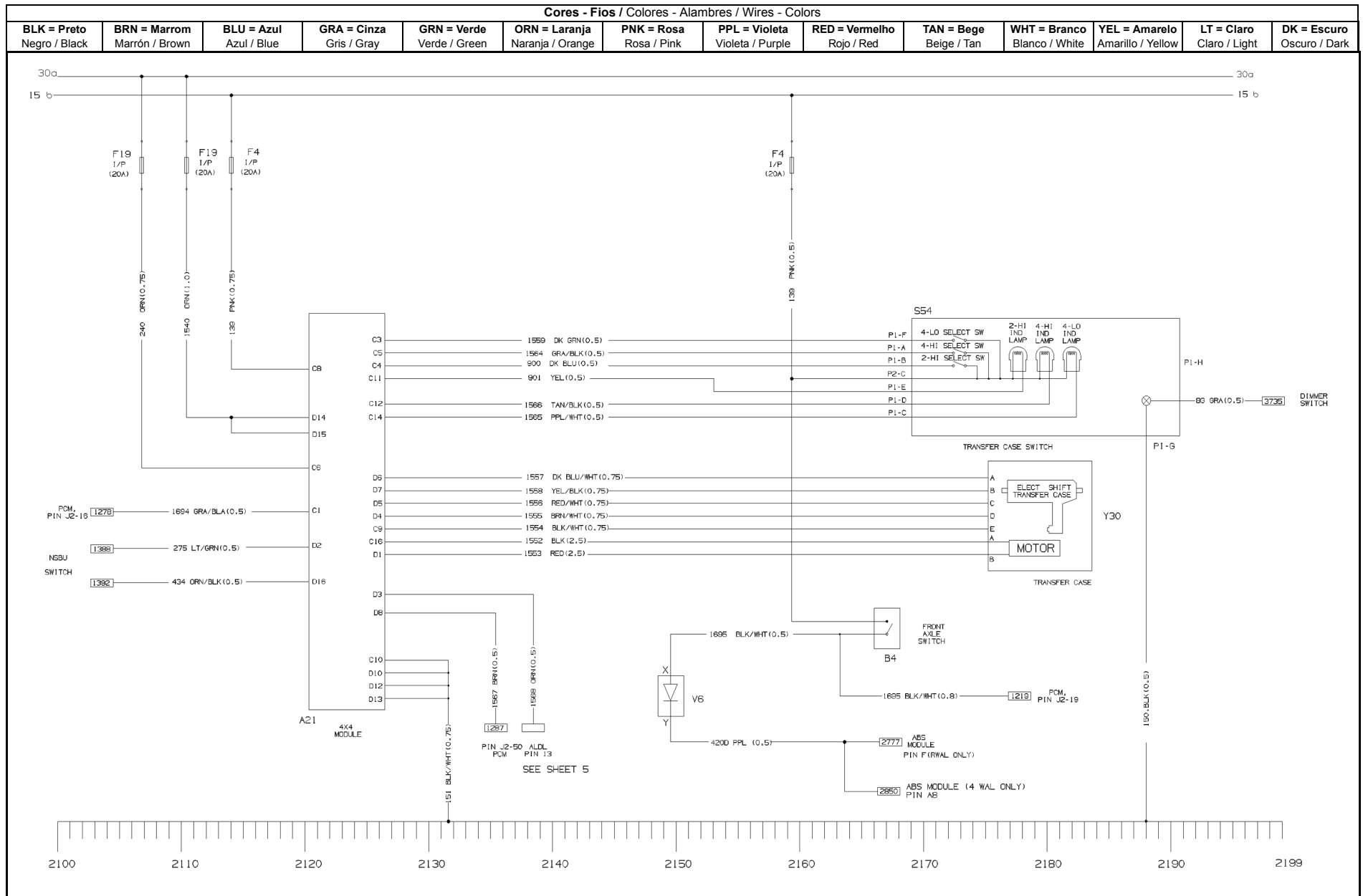

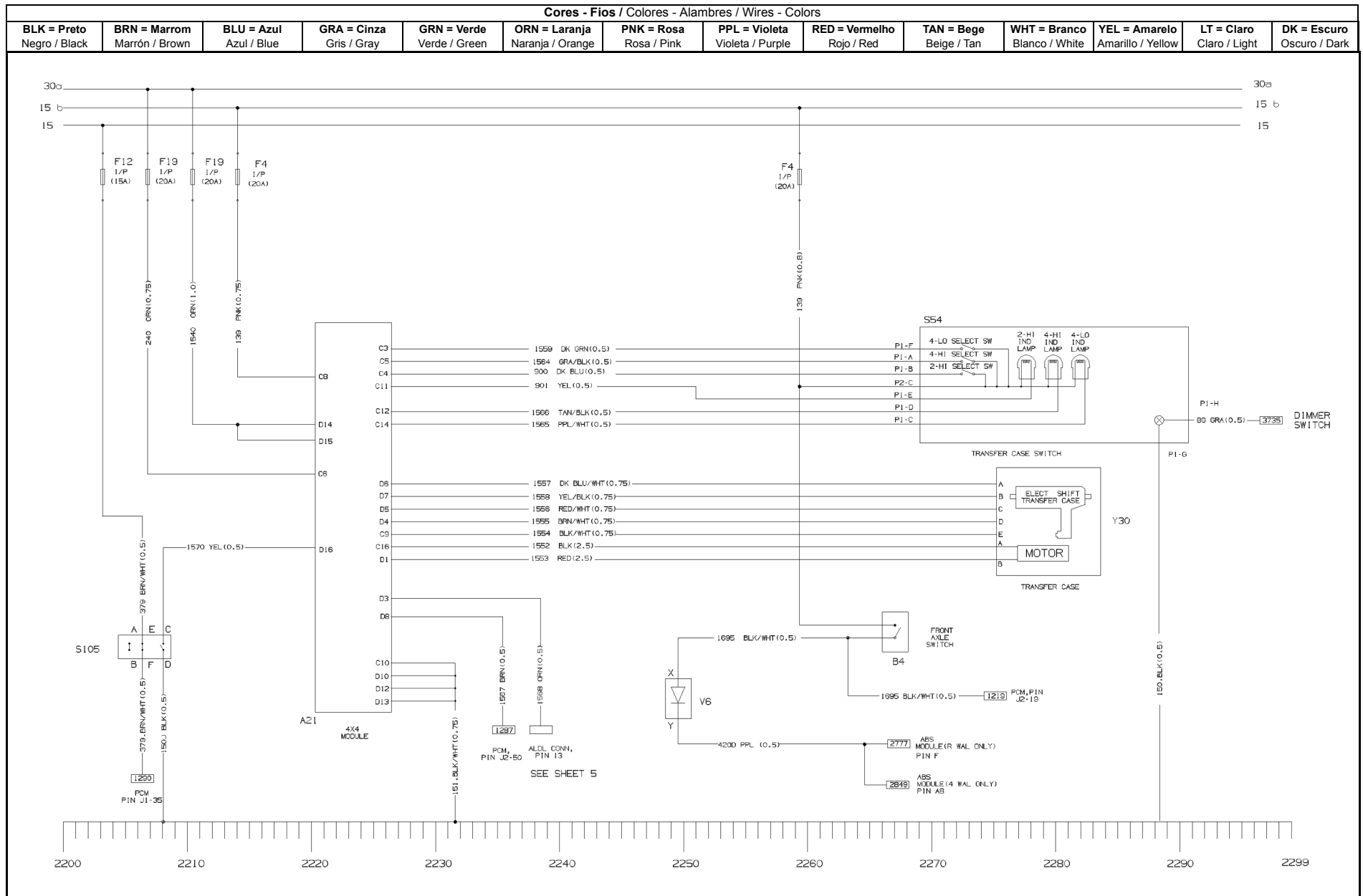

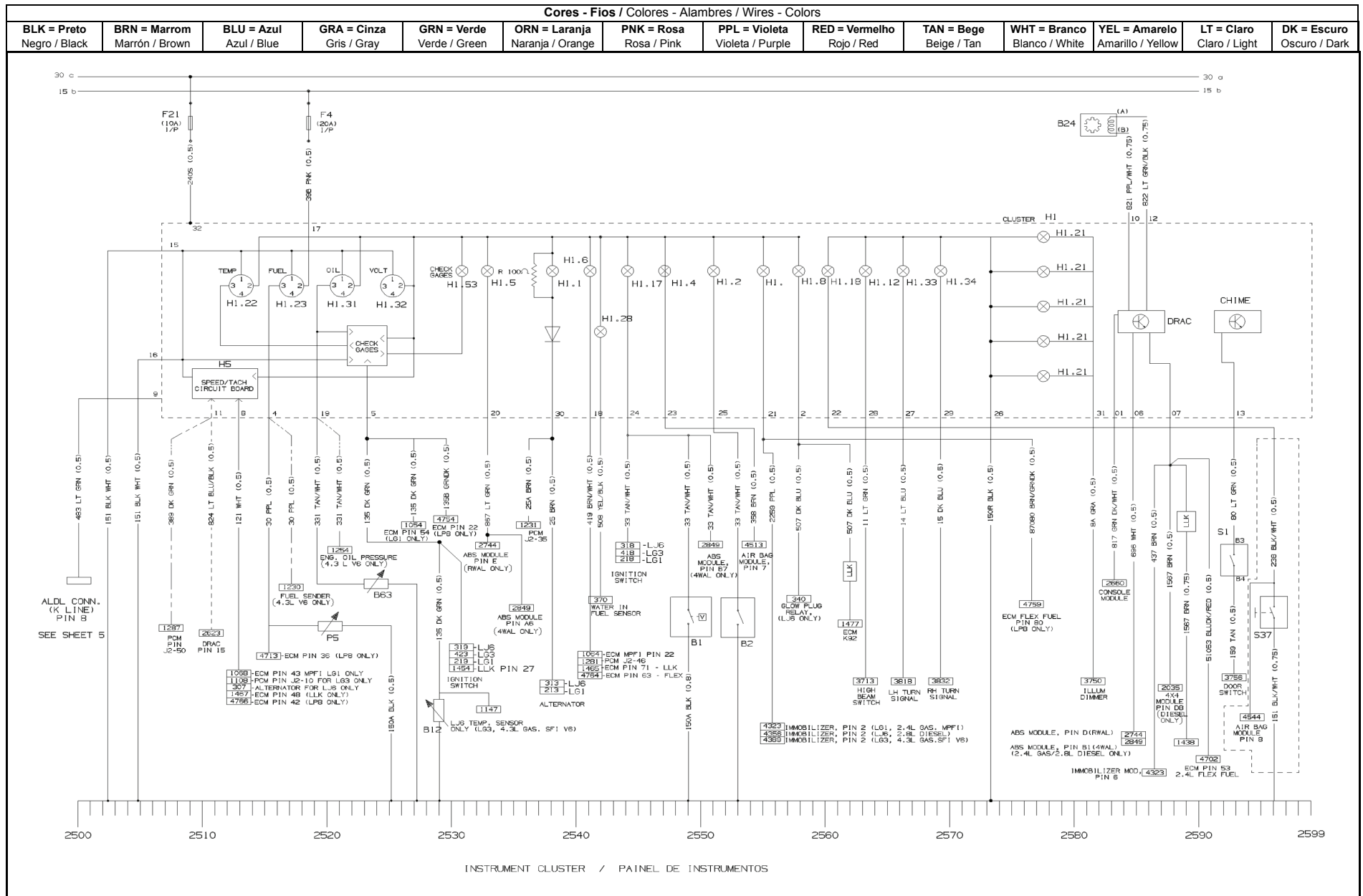

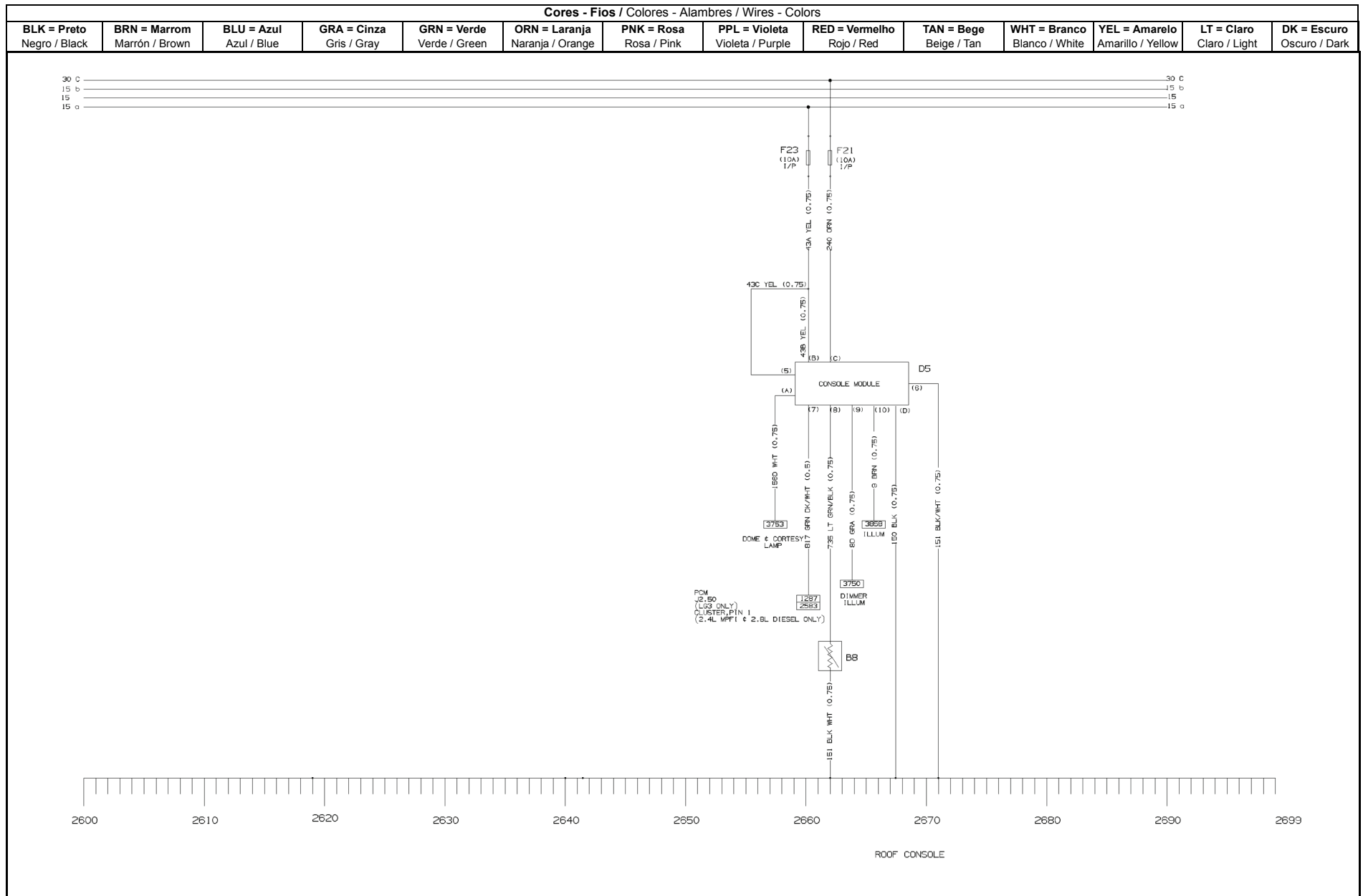

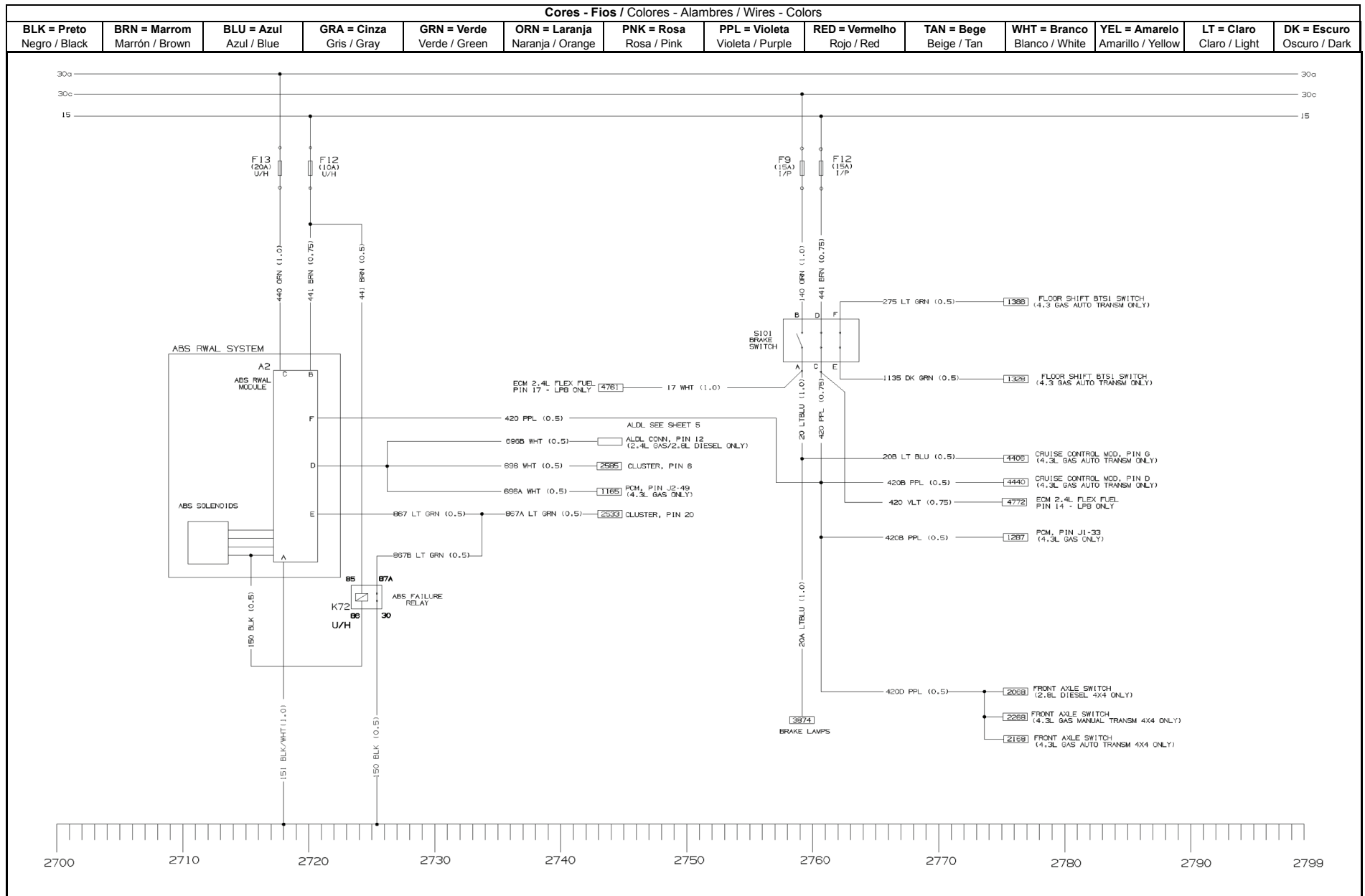

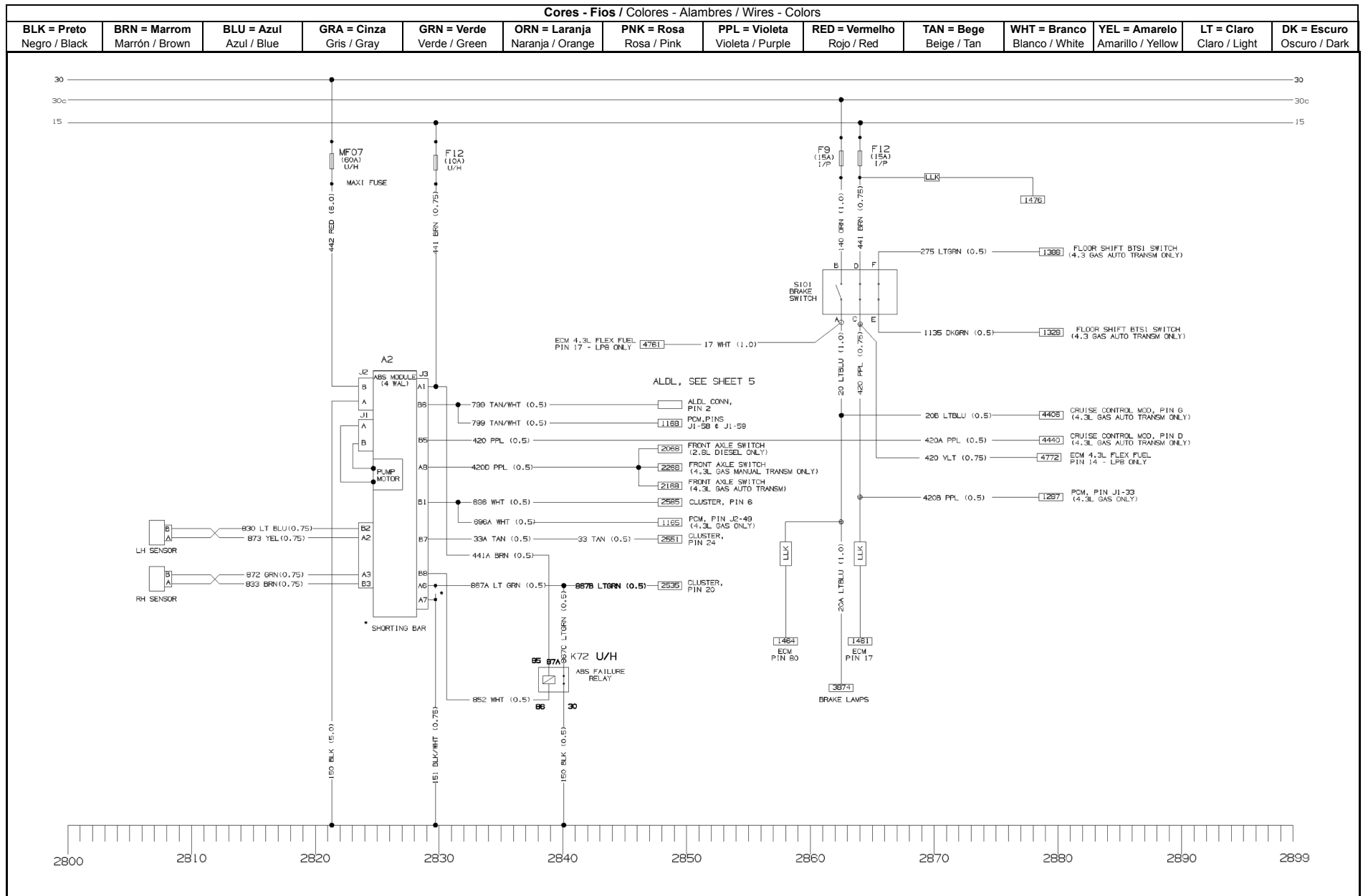

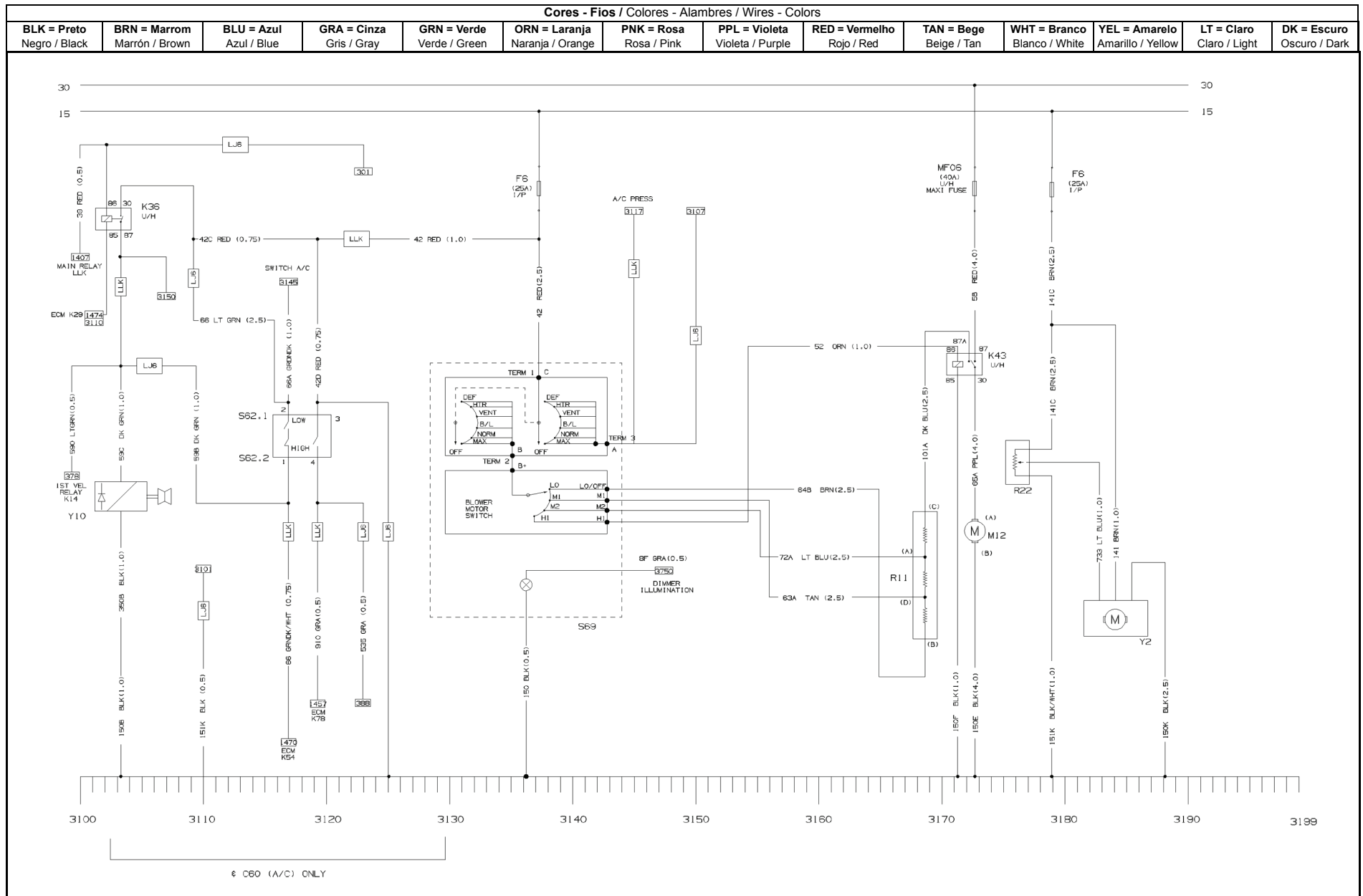

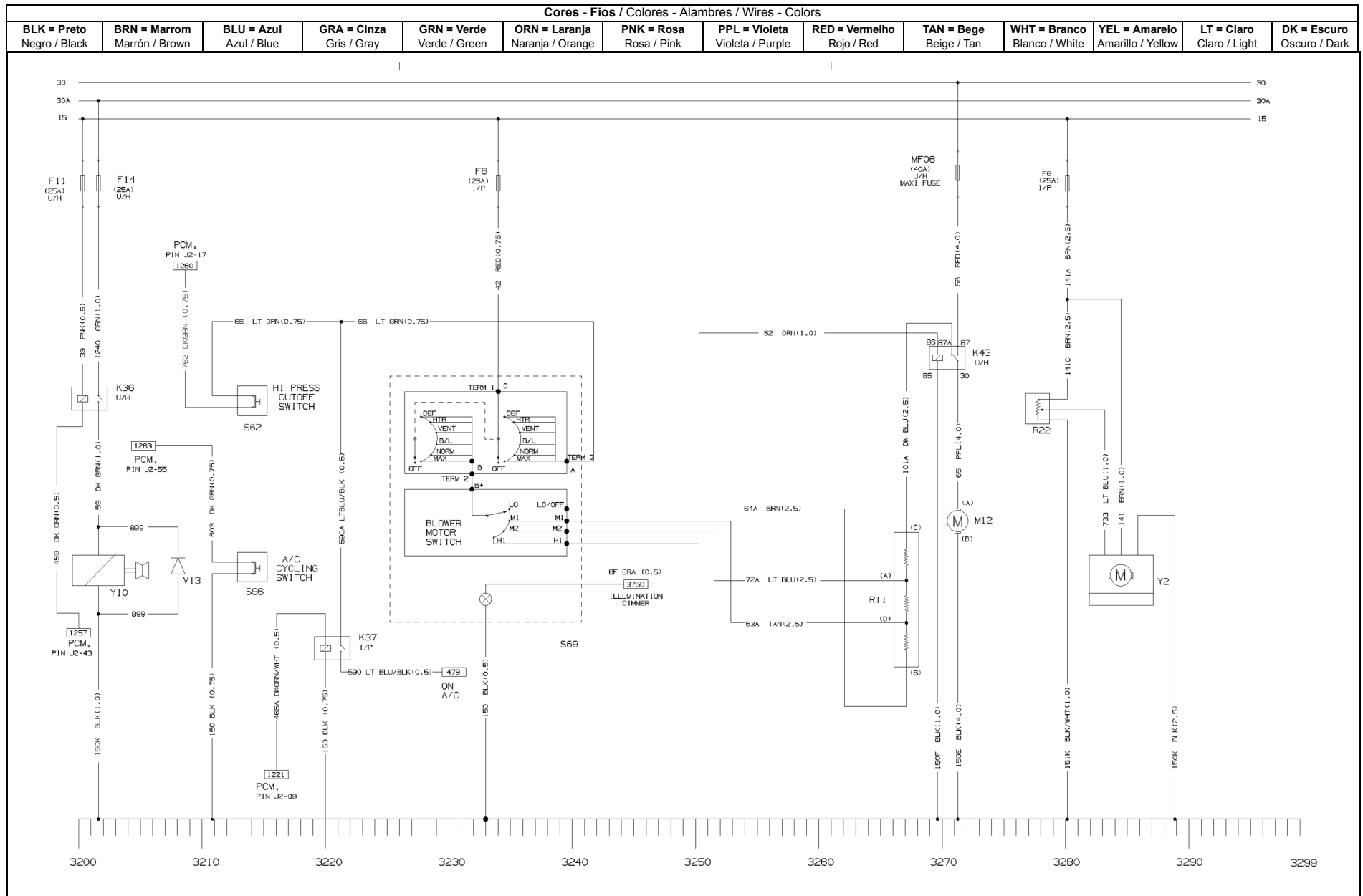

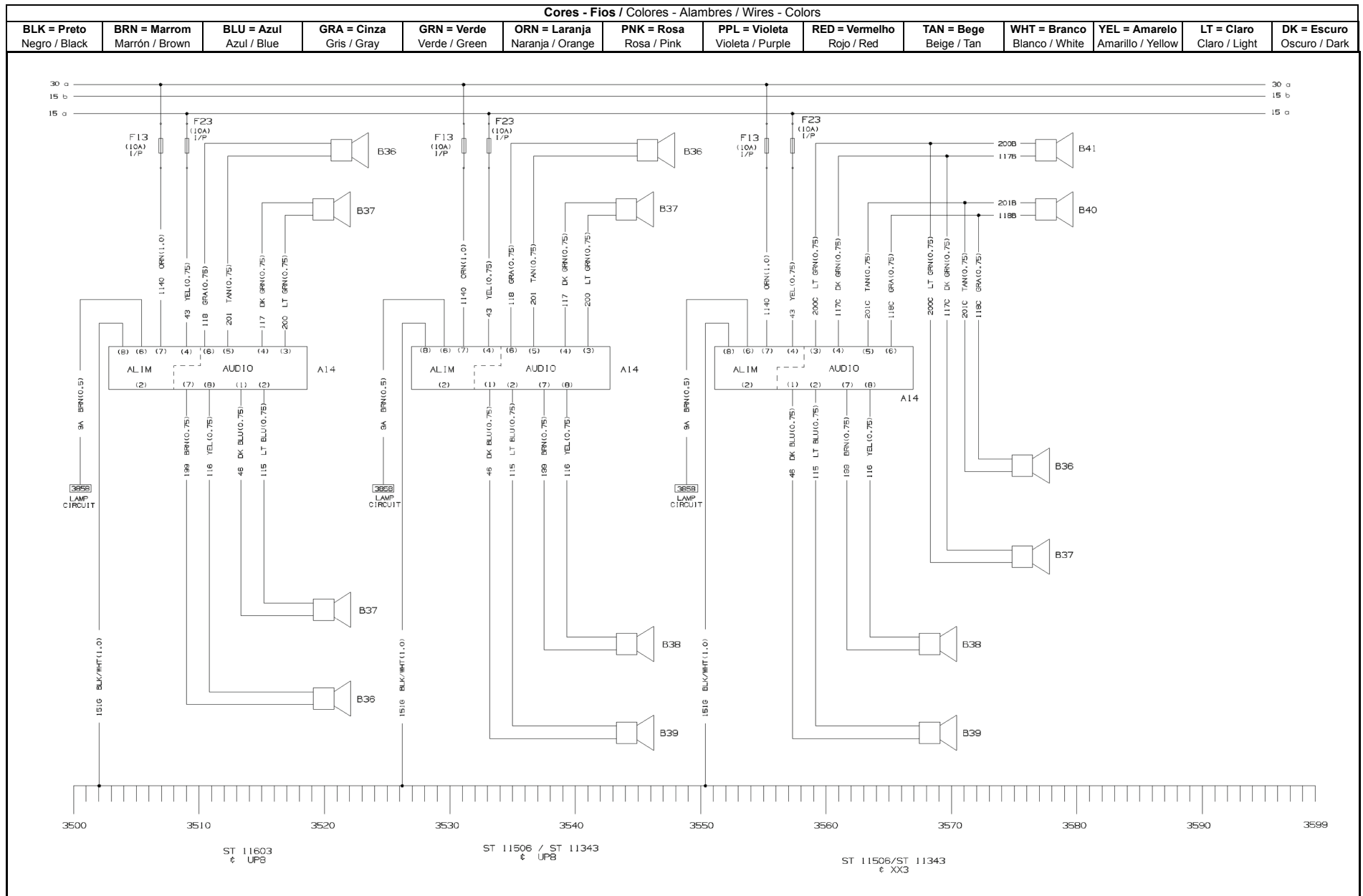

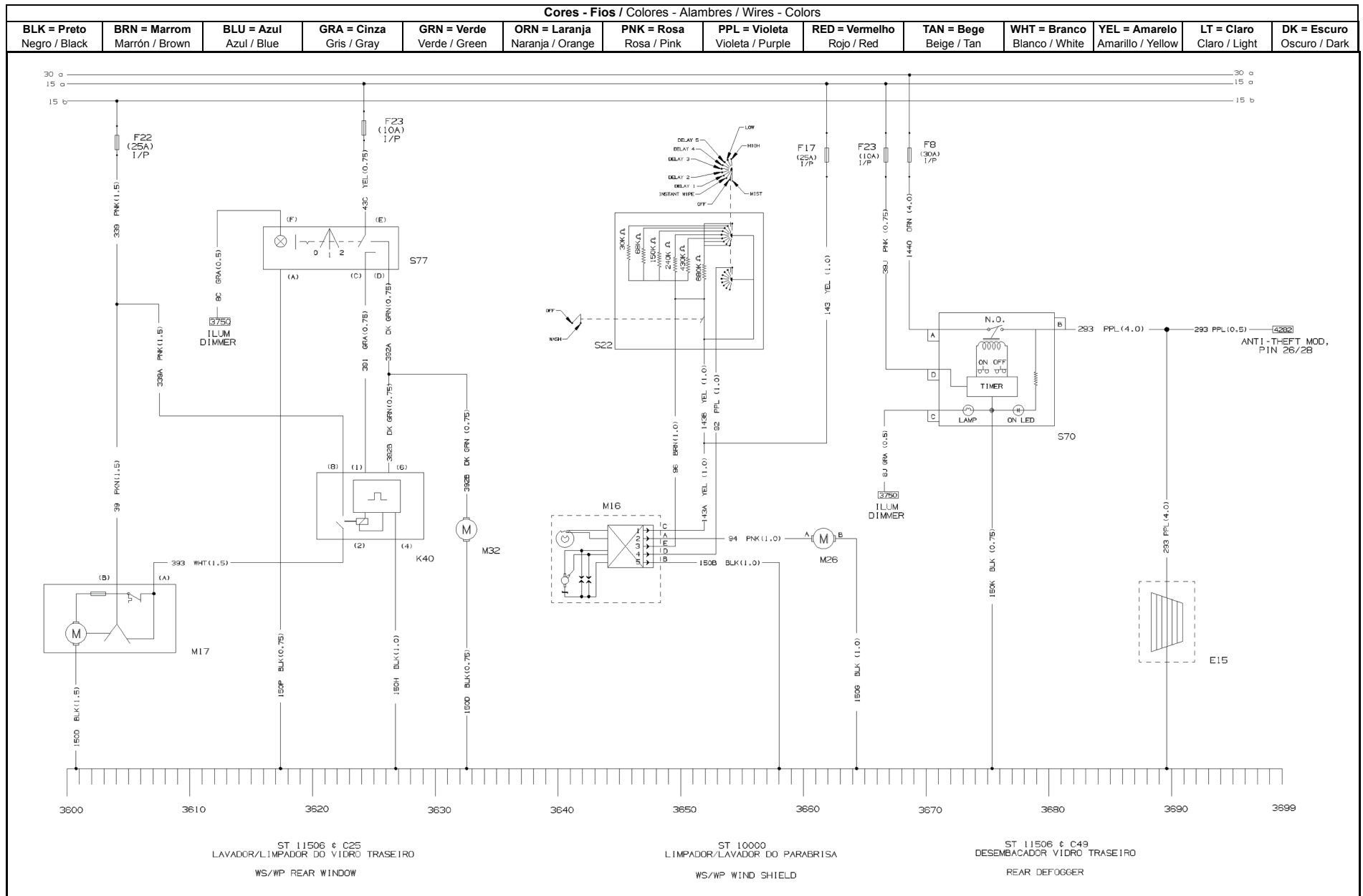

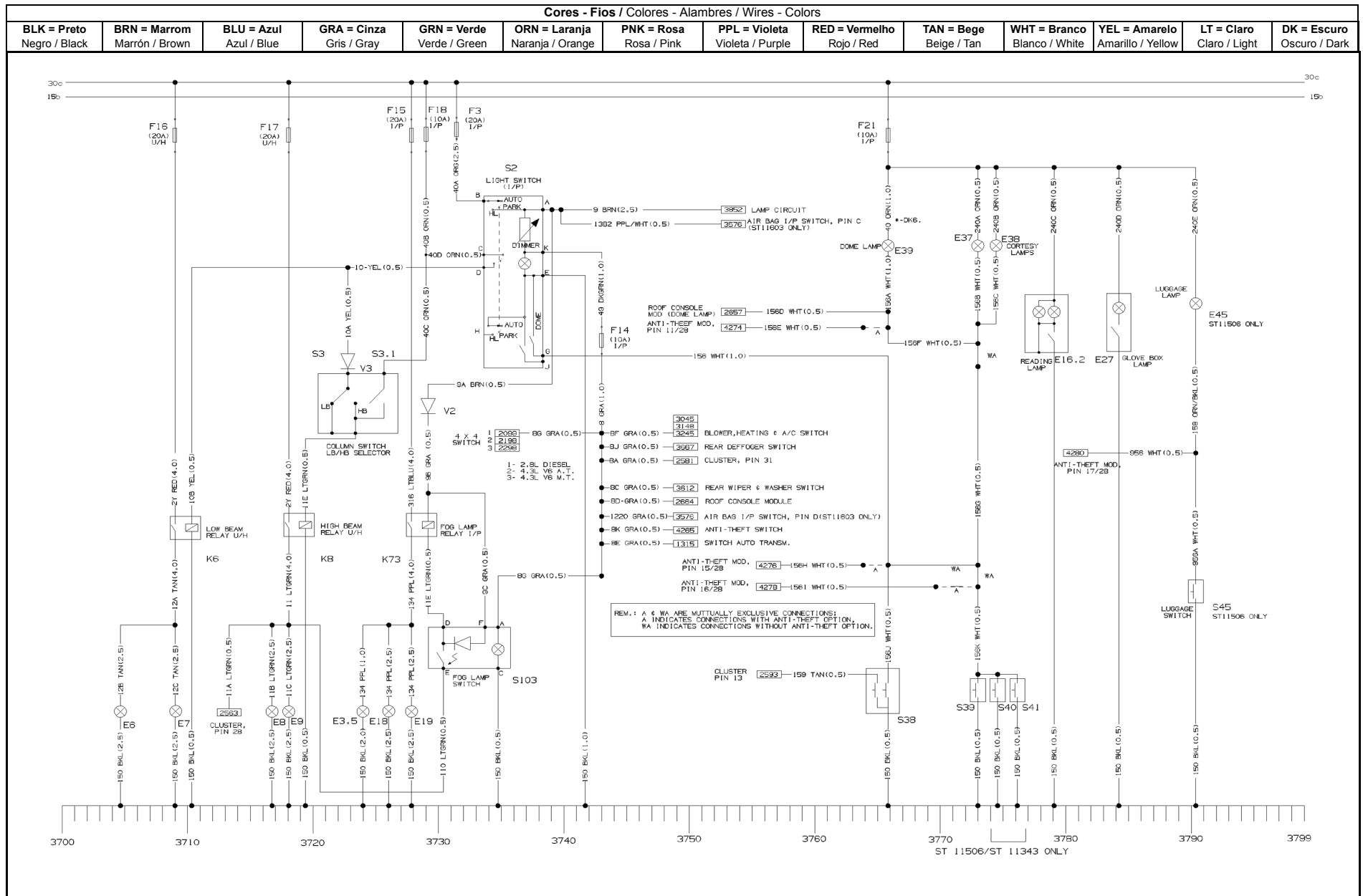

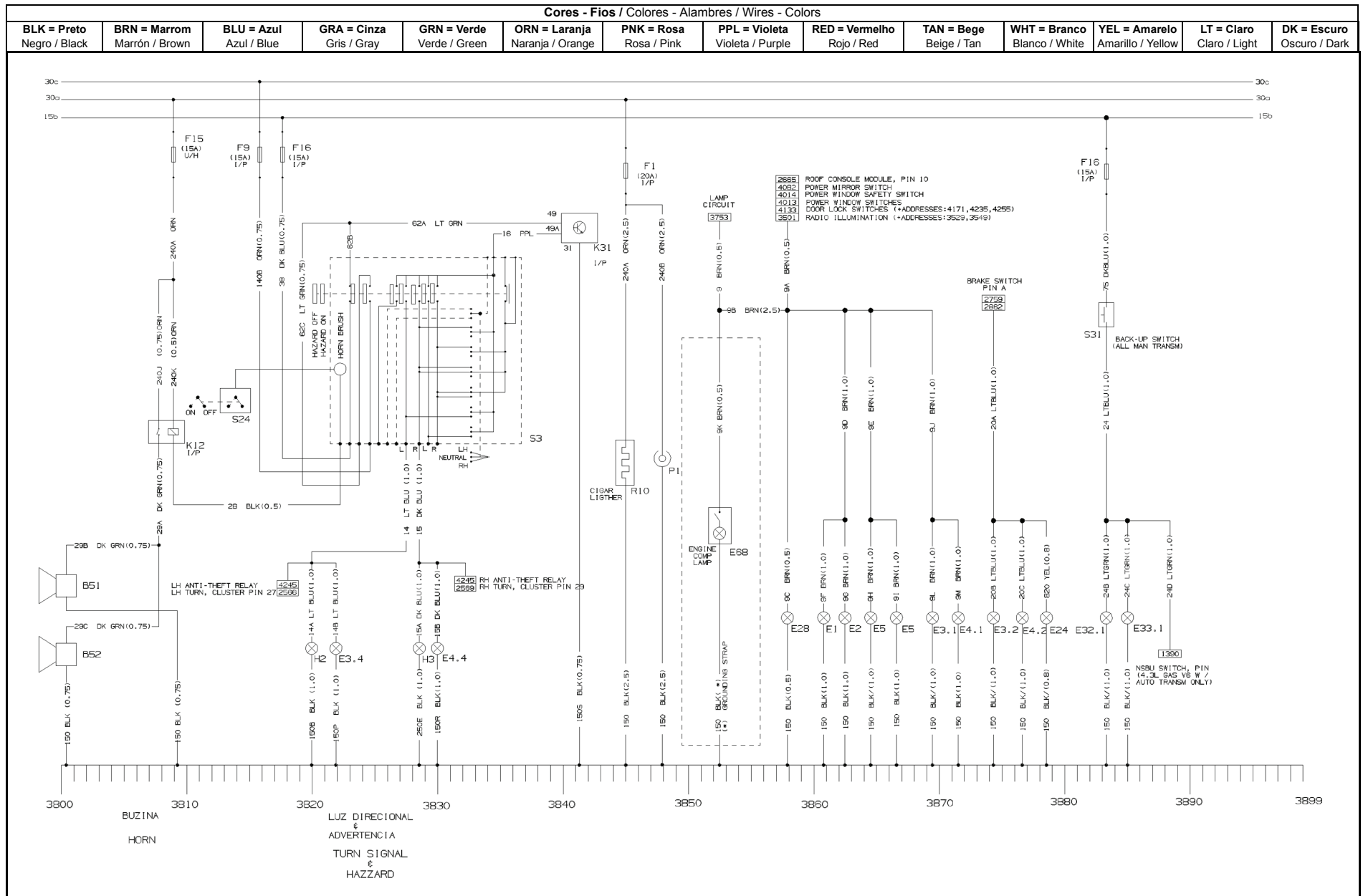

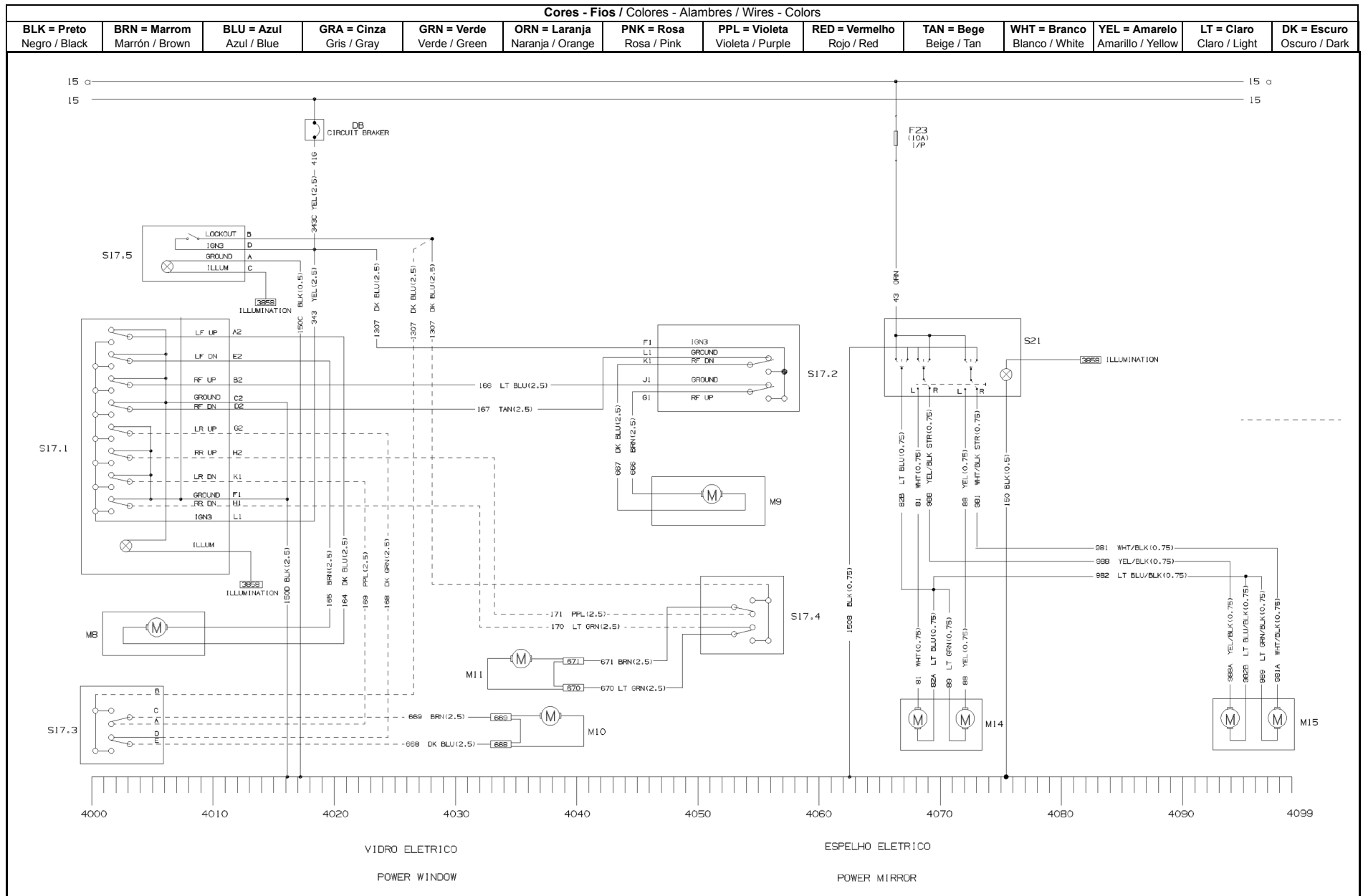

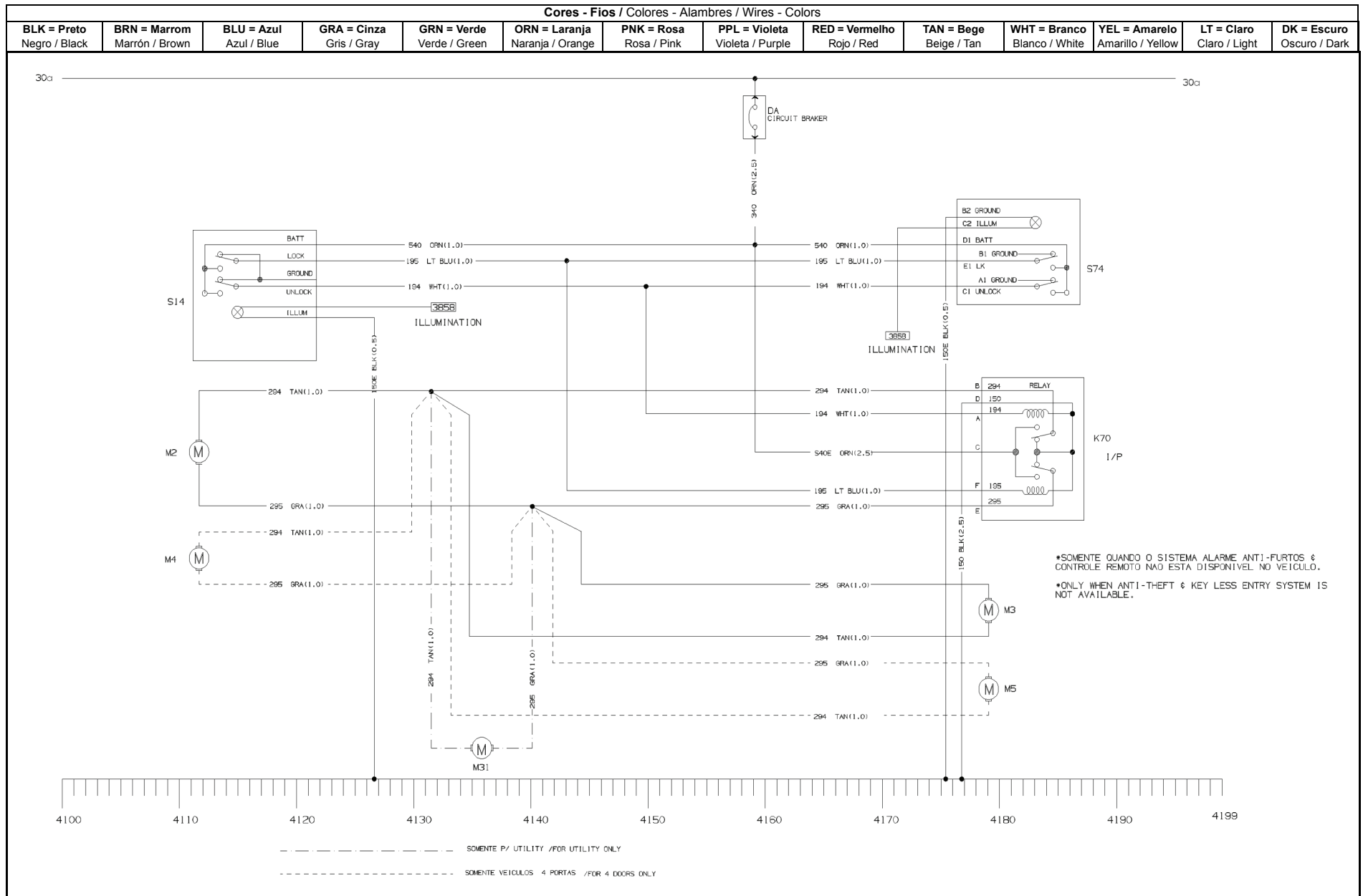

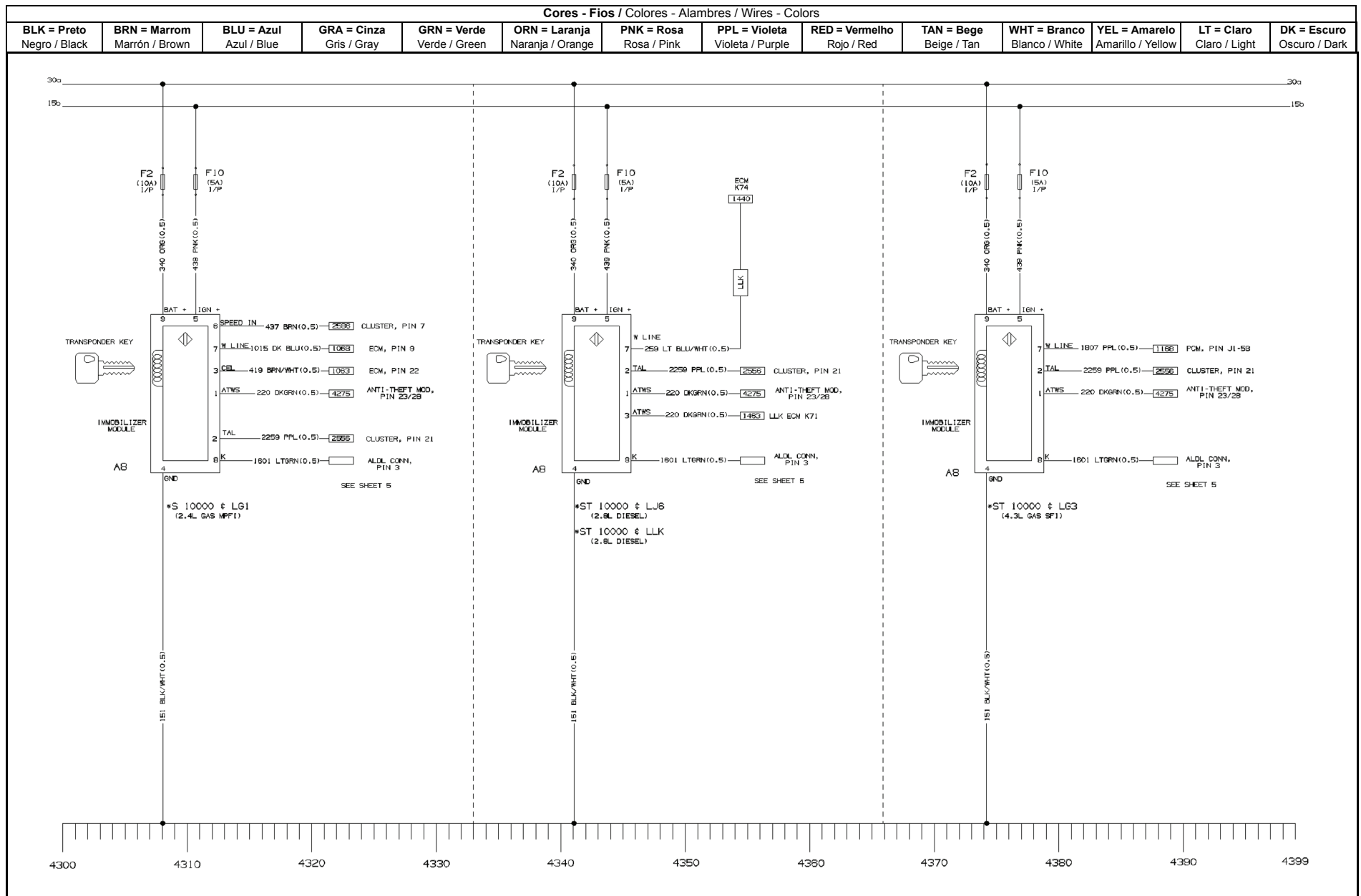

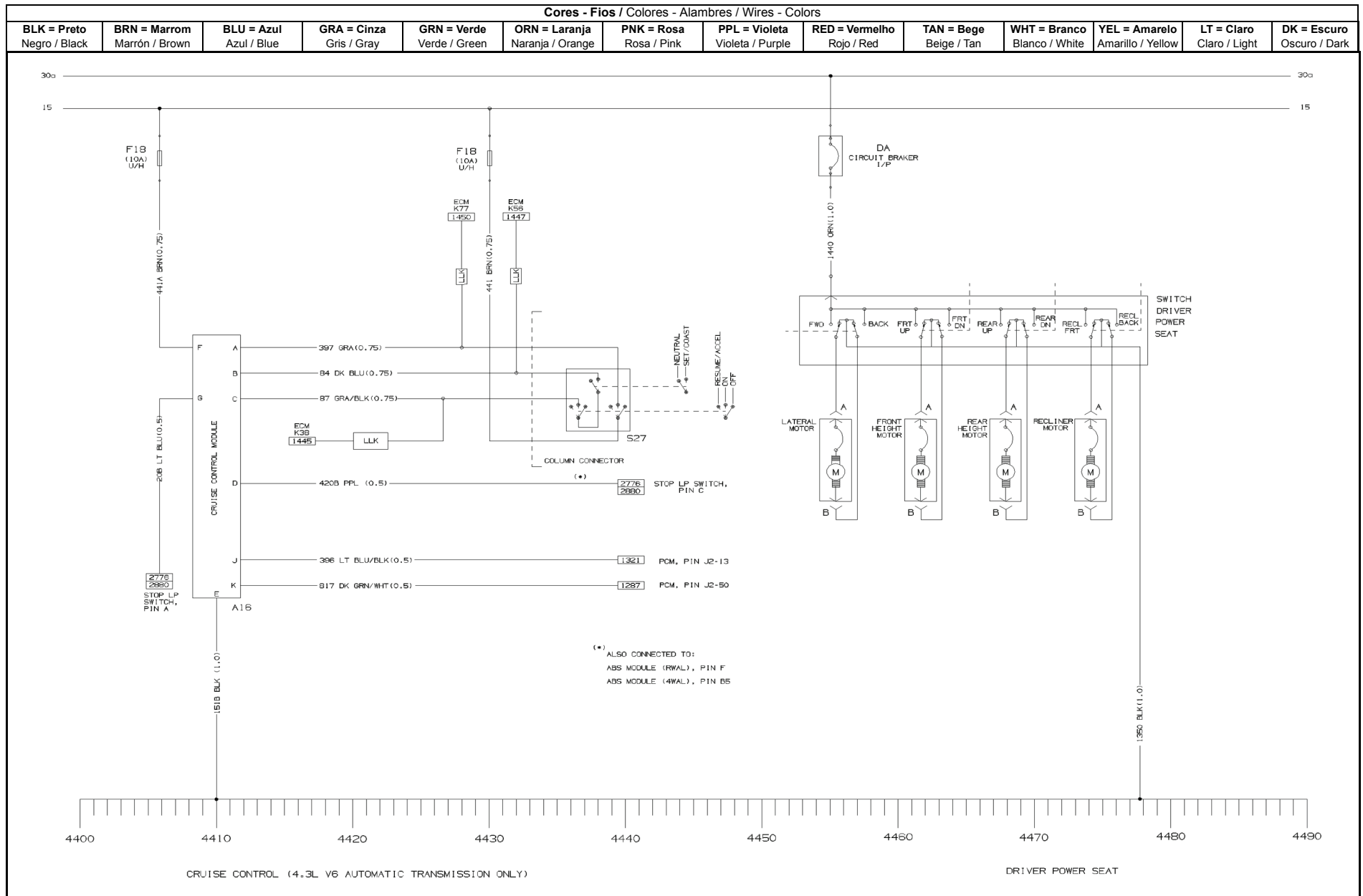

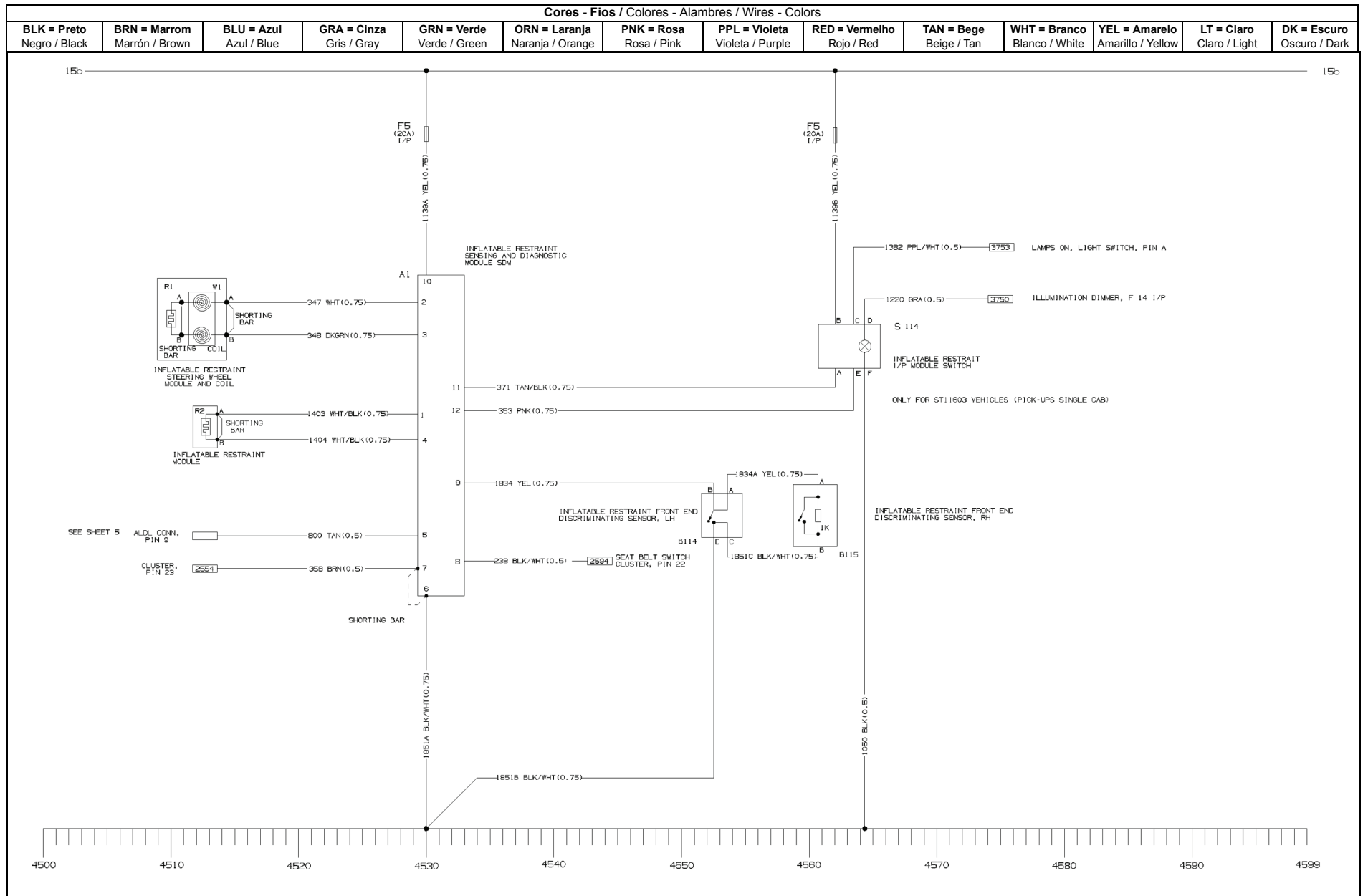

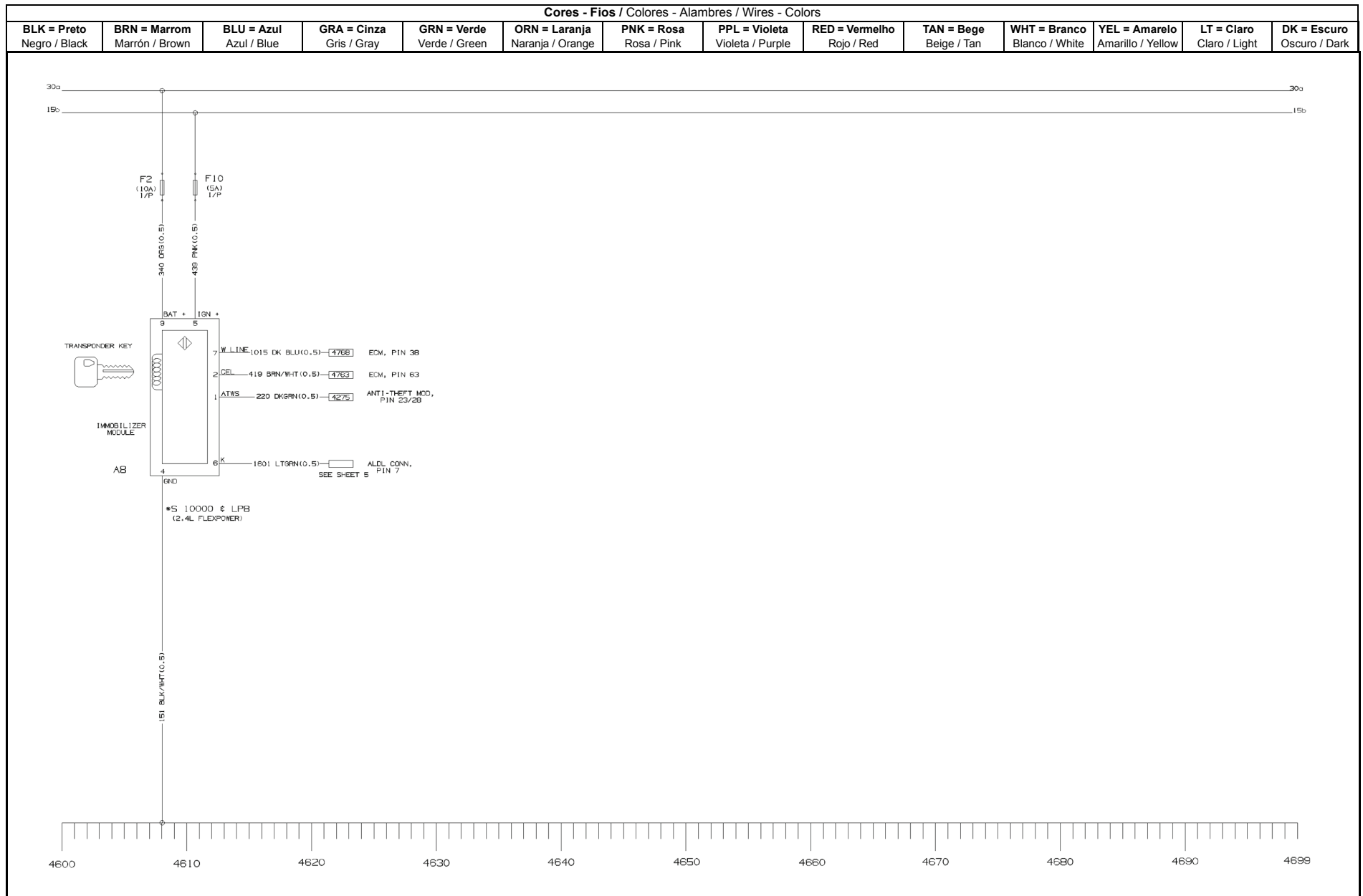

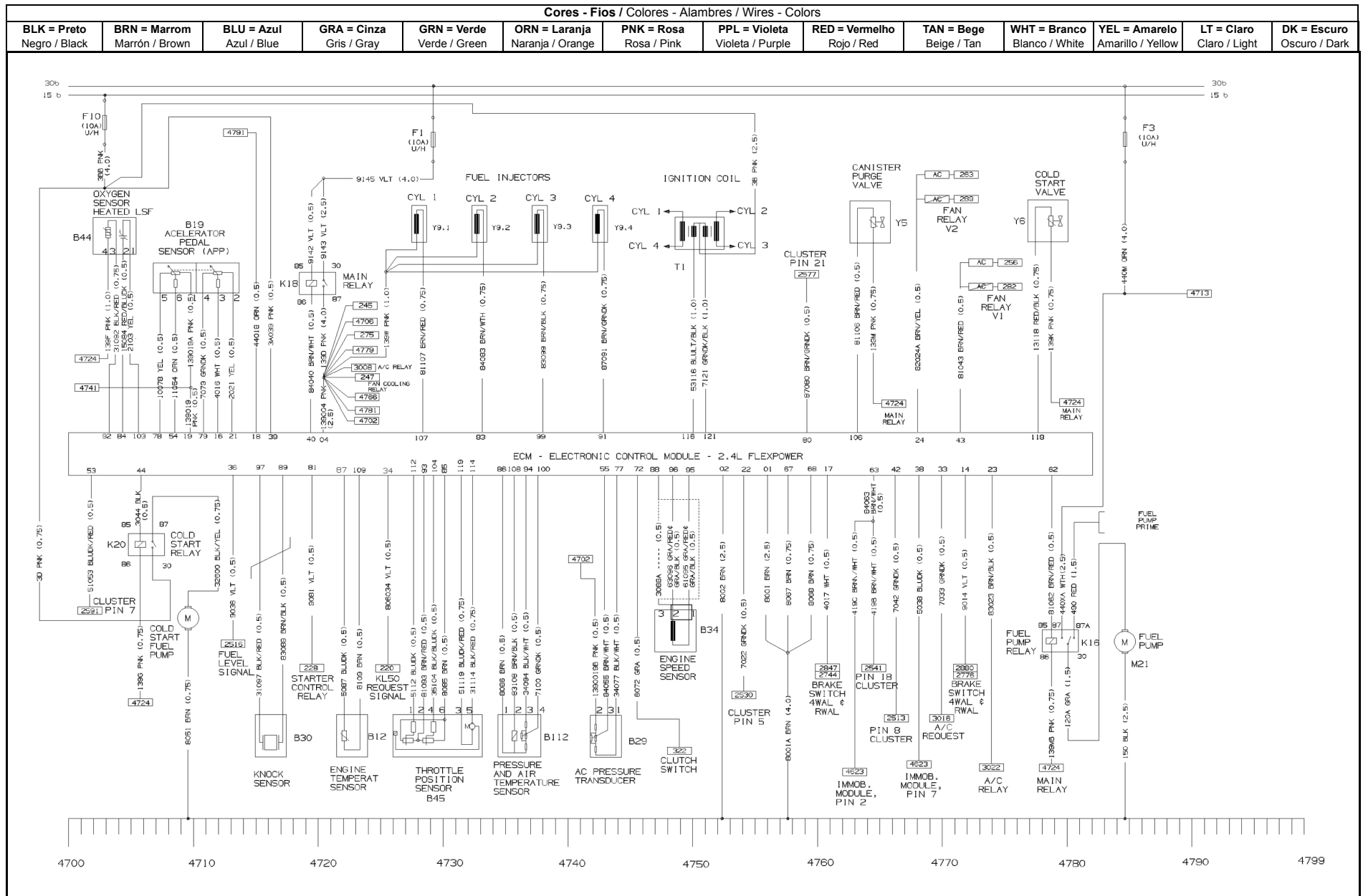

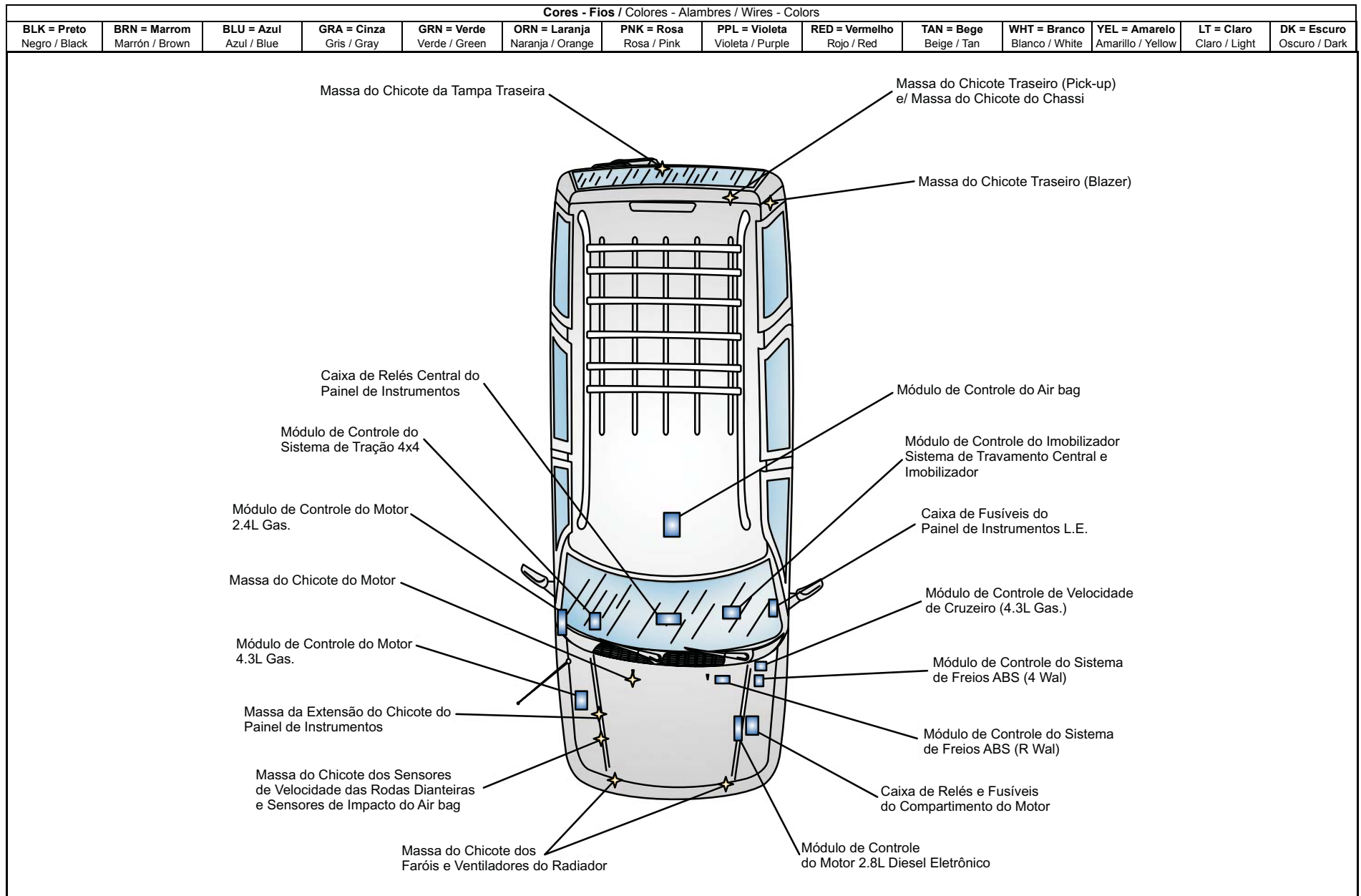

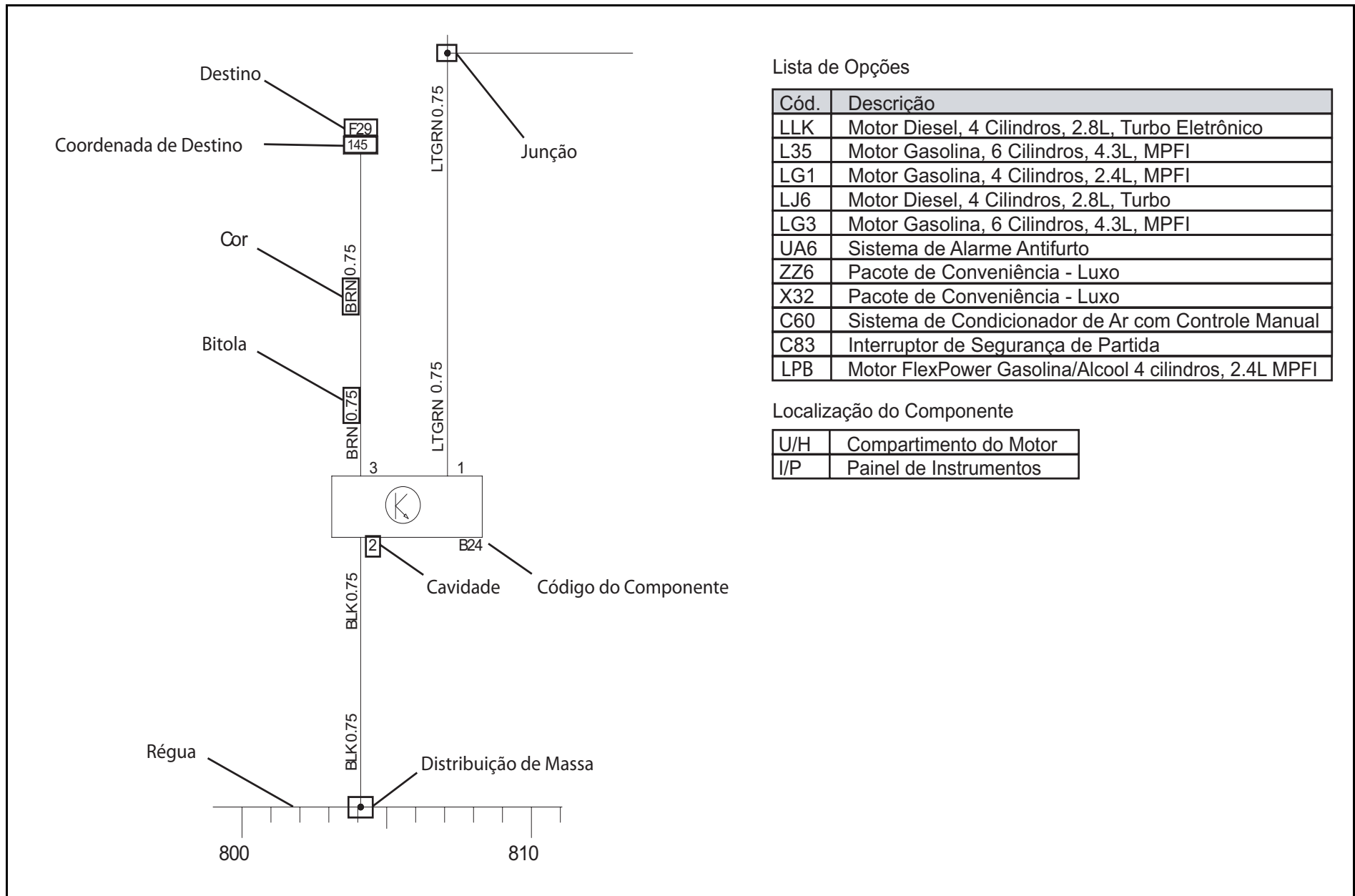

Cores - Fios / Colores - Alambres / Wires - Colors

BLK = Preto Negro / Black	BRN = Marrom Marrón / Brown	BLU = Azul Azul / Blue	GRA = Cinza Gris / Gray	GRN = Verde Verde / Green	ORN = Laranja Naranja / Orange	PNK = Rosa Rosa / Pink	PPL = Violeta Violeta / Purple	RED = Vermelho Rojo / Red	TAN = Bege Beige / Tan	WHT = Branco Blanco / White	YEL = Amarelo Amarillo / Yellow	LT = Claro Claro / Light	DK = Escuro Oscuro / Dark
-------------------------------------	---------------------------------------	----------------------------------	-----------------------------------	-------------------------------------	--	----------------------------------	--	-------------------------------------	----------------------------------	---------------------------------------	---	------------------------------------	-------------------------------------

FUSÍVEL	TIPO	CAPAC.	POSIÇÃO	DESCRIÇÃO
MF01	MAXIFUSÍVEL	30A	U/H	FUSÍVEL DO VENTILADOR DE ARREFECIMENTO-BAIXA VELOCIDADE
MF02	MAXIFUSÍVEL	30A	U/H	FUSÍVEL DO VENTILADOR DE ARREFECIMENTO-ALTA VELOCIDADE
MF03	MAXIFUSÍVEL	60A	U/H	FUSÍVEL DO CIRCUITO PRINCIPAL 30a
MF04	MAXIFUSÍVEL	60A	U/H	FUSÍVEL DO RELÉ AUXILIAR DE PARTIDA
MF05	MAXIFUSÍVEL	30A/60A	U/H	FUSÍVEL DO CIRCUITO PRINCIPAL 30b / FUSÍVEL DAS VELAS AQUECEDORAS
MF06	MAXIFUSÍVEL	40A	U/H	FUSÍVEL DE VENTILAÇÃO INTERNA
MF07	MAXIFUSÍVEL	60A	U/H	FUSÍVEL DO MÓDULO DE FREIO ABAS NAS 4 RODAS 4WAL
MF08	MAXIFUSÍVEL	50A	U/H	FUSÍVEL DO CIRCUITO PRINCIPAL 30c
MF09	MAXIFUSÍVEL	50A	U/H	FUSÍVEL DO CIRCUITO PRINCIPAL 15b
MF10	MAXIFUSÍVEL	50A	U/H	FUSÍVEL DOS CIRCUITOS PRINCIPAIS 15 E 15a

FUSÍVEL	TIPO	CAPAC.	POSIÇÃO	DESCRIÇÃO
F1	MINIFUSÍVEL	10A	U/H	FUSÍVEL: ECM (MPFI 2.4L) / RELÉ PRINCIPAL / SENSOR PRESSÃO DE ÓLEO
F2	MINIFUSÍVEL	10A	U/H	FUSÍVEL: RELÉ DE ARREFECIMENTO / INTERRUPTOR DO SOLENÓIDE (DIESEL 2.8L)
F3	MINIFUSÍVEL	10A	U/H	FUSÍVEL: ECM (MPFI 2.4 L) / RELÉ DA BOMBA DE COMBUSTÍVEL
F4	MINIFUSÍVEL	10A	U/H	FUSÍVEL: PCM / CANISTER / AQUECEDOR
F5	MINIFUSÍVEL	20A	U/H	FUSÍVEL: PCM / BOBINA DE IGNIÇÃO / MAF / INJETORES
F6	MINIFUSÍVEL	15A	U/H	FUSÍVEL: PCM / BOMBA DE COMBUSTÍVEL / SENSOR DE ÓLEO
F7	MINIFUSÍVEL	10A	U/H	FUSÍVEL: RELÉ, PARTIDA
F8	MINIFUSÍVEL	-	U/H	FUSÍVEL: LIVRE
F9	MINIFUSÍVEL	-	U/H	FUSÍVEL: LIVRE
F10	MINIFUSÍVEL	10A	U/H	FUSÍVEL: BOMBA DO SISTEMA DE PARTIDA A FRIO
F11	MINIFUSÍVEL	25A	U/H	FUSÍVEL: RELÉ DO AR CONDICIONADO
F12	MINIFUSÍVEL	10A	U/H	FUSÍVEL: MÓDULO ABS RODAS TRASEIRAS (RWAL)
F13	MINIFUSÍVEL	20A	U/H	FUSÍVEL: MÓDULO ABS RODAS TRASEIRAS (RWAL)
F14	MINIFUSÍVEL	25A	U/H	FUSÍVEL: COMPRESSOR DO AR CONDICIONADO (4.3L V6)
F15	MINIFUSÍVEL	15A	U/H	FUSÍVEL: BUZINA
F16	MINIFUSÍVEL	20A	U/H	FUSÍVEL: FAROL BAIXO
F17	MINIFUSÍVEL	20A	U/H	FUSÍVEL: FAROL ALTO
F18	MINIFUSÍVEL	10A	U/H	FUSÍVEL: MÓDULO DE CONTROLE AUTOMÁTICO

FUSÍVEL	POSIÇÃO	DESCRIÇÃO	USO
K6	U/H	RELÉ DOS FARÓIS BAIXOS	ALL
K8	U/H	RELÉ DOS FARÓIS ALTOS	&LG1 / &LG3
K13	U/H	RELÉ DE ALTA VELOCIDADE DO VENTILADOR DE ARREFECIMENTO	&LG1 / &LLK
K14	U/H	RELÉ DE BAIXA VELOCIDADE DO VENTILADOR DE ARREFECIMENTO	&LG1 / &LLK
K14.1	U/H	RELÉ SÉRIE-PARALELO DO VENTILADOR DE ARREFECIMENTO	&LG1
K18	U/H	RELÉ PRINCIPAL DO SISTEMA DE INJEÇÃO MPFI	&LG1
K24	U/H	RELÉ AUXILIAR DE PARTIDA	&LG1 / &LG3
K36	U/H	RELÉ DO COMPRESSOR DE A/C	&C60 / &LLK
K43	U/H	RELÉ DE VENTILAÇÃO INTERNA	LG1 / LG3
K72	U/H	RELÉ DE FALHA DO SISTEMA ABS	&JA4 / &JM4 / &LLK
K80	U/H	RELÉ PRINCIPAL	&LLK

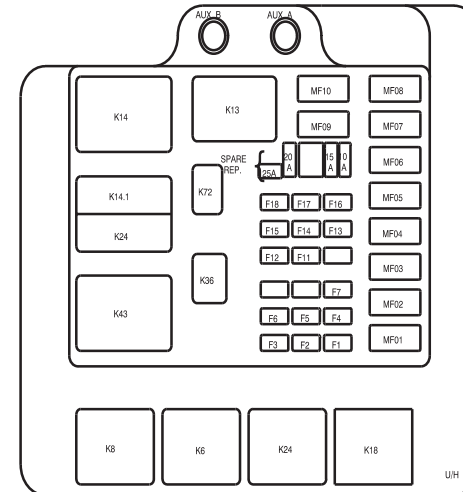

MOTOR 2.4L GASOLINA / FLEXPOWER

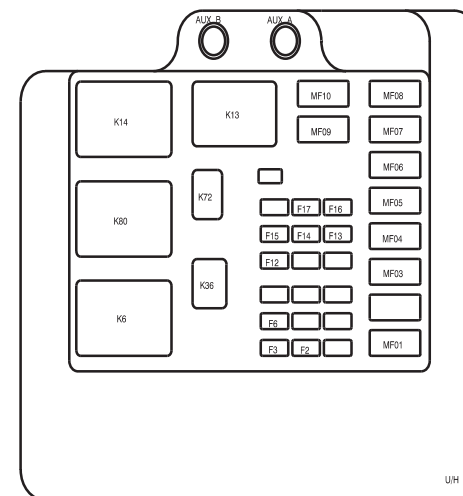

MOTOR 2.8L DIESEL



Cores - Fios / Colores - Alambres / Wires - Colors

BLK = Preto Negro / Black	BRN = Marrom Marrón / Brown	BLU = Azul Azul / Blue	GRA = Cinza Gris / Gray	GRN = Verde Verde / Green	ORN = Laranja Naranja / Orange	PNK = Rosa Rosa / Pink	PPL = Violeta Violeta / Purple	RED = Vermelho Rojo / Red	TAN = Bege Beige / Tan	WHT = Branco Blanco / White	YEL = Amarelo Amarillo / Yellow	LT = Claro Claro / Light	DK = Escuro Oscuro / Dark
-------------------------------------	---------------------------------------	----------------------------------	-----------------------------------	-------------------------------------	--	----------------------------------	--	-------------------------------------	----------------------------------	---------------------------------------	---	------------------------------------	-------------------------------------

RELÉ	DESCRIÇÃO	USO
K2	RELÉ DO ALARME - INDICADOR DIREÇÃO LD	& UA6
K3	RELÉ DO ALARME - INDICADOR DIREÇÃO LE	& UA6
K12	RELÉ DE ACIONAMENTO DA BUZINA	TODOS
K16	RELÉ DA BOMBA DE COMBUSTÍVEL	&LG1 / &LG3 / &LLK
K20	RELÉ DE PARTIDA A FRIO	LP8
K31	RELÉ DOS INDICADORES DE DIREÇÃO (BLINKER)	TODOS
K37	RELÉ MOTOR LIGADO	&LG3
K40	RELÉ LIMPADOR E LAVADOR DO VIDRO TRASEIRO	ST11506
K70	RELÉ MÓDULO DAS TRAVAS DAS PORTAS	&X32 / &ZZ6 - UA6
K73	RELÉ DOS FARÓIS AUXILIARES DE NEBLINA	&X32 / &ZZ6 / &UOM
H9	MÓDULO INTERNO DE ALARME (CHIME)	TODOS

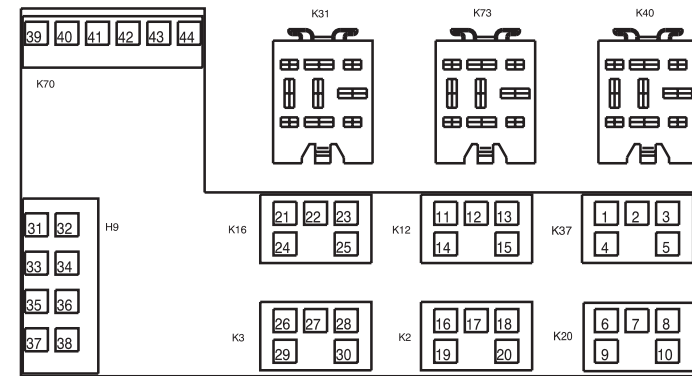

Cores - Fios / Colores - Alambres / Wires - Colors													
BLK = Preto Negro / Black	BRN = Marrrom Marrón / Brown	BLU = Azul Azul / Blue	GRA = Cinza Gris / Gray	GRN = Verde Verde / Green	ORN = Laranja Naranja / Orange	PNK = Rosa Rosa / Pink	PPL = Violeta Violeta / Purple	RED = Vermelho Rojo / Red	TAN = Bege Beige / Tan	WHT = Branco Blanco / White	YEL = Amarelo Amarillo / Yellow	LT = Claro Claro / Light	DK = Escuro Oscuro / Dark
FUSÍVEL	TIPO	POSIÇÃO	DESCRIÇÃO										
F1	MINIFUSÍVEL	20A I/P	FUSÍVEL: ACENDEDOR DE CIGARROS (E TOMADA DE FORÇA 12V)										
F2	MINIFUSÍVEL	10A I/P	FUSÍVEL: MÓDULO ALARME ANTIFURTO										
F3	MINIFUSÍVEL	20A I/P	FUSÍVEL: ILUMINAÇÃO: LANTERNAS TRAS. / PLACA DE LICENÇA / ACENDEDOR DE CIGARROS / SISTEMA DE SOM / INTERIOR CAPUZ / LUZ DO TETO / INTERRUPTOR DE ILUMINAÇÃO / LUZES DE ESTACIONAMENTO										
F4	MINIFUSÍVEL	20A I/P	FUSÍVEL: PAINEL DE INSTRUMENTOS / MÓDULO 4X4 / 4X4 – INTERRUPTOR DO EIXO DIANTEIRO										
F5	MINIFUSÍVEL	20A I/P	FUSÍVEL: MÓDULO AIR BAG (DUPL0)										
F6	MINIFUSÍVEL	25A I/P	FUSÍVEL: VENTILAÇÃO / AR CONDICIONADO										
F7	MINIFUSÍVEL	25A I/P	FUSÍVEL: ALDL										
F8	MINIFUSÍVEL	30A I/P	FUSÍVEL: DESEMBAÇADOR TRASEIRO										
F9	MINIFUSÍVEL	15A I/P	FUSÍVEL: LUZES DE ALERTA / INTERRUPTOR DO FREIO / MÓDULO DE ALARME INTERNO										
F10	MINIFUSÍVEL	5A I/P	FUSÍVEL: MÓDULO IMOBILIZADOR DE IGNIÇÃO & PARTIDA / MÓDULO DE ALARME										
F11	MINIFUSÍVEL	20A I/P	FUSÍVEL: INTERRUPTOR NSBU (4.3L V6 AT)										
F12	MINIFUSÍVEL	15A I/P	FUSÍVEL: DRAC / MÓDULO DE ALARME INTERNO / INTERRUPTOR DO FREIO (ABS)										
F13	MINIFUSÍVEL	10A I/P	FUSÍVEL: SISTEMA DE SOM										
F14	MINIFUSÍVEL	10A I/P	FUSÍVEL: REDUTOR DE TENSÃO										
F15	MINIFUSÍVEL	20A I/P	FUSÍVEL: FAROL DE NEBLINA / LANTERNA TRASEIRA DE NEBLINA										
F16	MINIFUSÍVEL	15A I/P	FUSÍVEL: INDICADOR DE DIREÇÃO / LUZES DE RÉ / NSBU INTERRUPTOR (4.3L V6 AT)										
F17	MINIFUSÍVEL	25A I/P	FUSÍVEL: LIMPADOR E LAVADOR DIANTEIRO										
F18	MINIFUSÍVEL	10A I/P	FUSÍVEL: COMANDO DE FARÓIS										
F19	MINIFUSÍVEL	20A I/P	FUSÍVEL: MÓDULO 4X4										
F20	MINIFUSÍVEL	- I/P	LIVRE										
F21	MINIFUSÍVEL	10A I/P	FUSÍVEL: LUZ DE CORTESIA / ILUM. CONSOLE DO TETO / LUZ DE LEITURA / PAINEL DE INSTRUMENTOS										
F22	MINIFUSÍVEL	25A I/P	FUSÍVEL: LIMPADOR E LAVADOR TRASEIRO										
F23	MINIFUSÍVEL	10A I/P	FUSÍVEL: ESPELHO ELÉTRICO / ILUM. CONSOLE DO TETO / INTERRUPTOR DO LIMPADOR E LAVADOR TRASEIRO / DESEMBAÇADOR TRASEIRO / RÁDIO										
F24	MINIFUSÍVEL	- I/P	LIVRE										
DA	DISJUNTOR	I/P	DISJUNTOR: TRAVA ELÉTRICA DAS PORTAS										
DB	DISJUNTOR	I/P	DISJUNTOR: LEVANTADOR DO VIDRO ELÉTRICO										

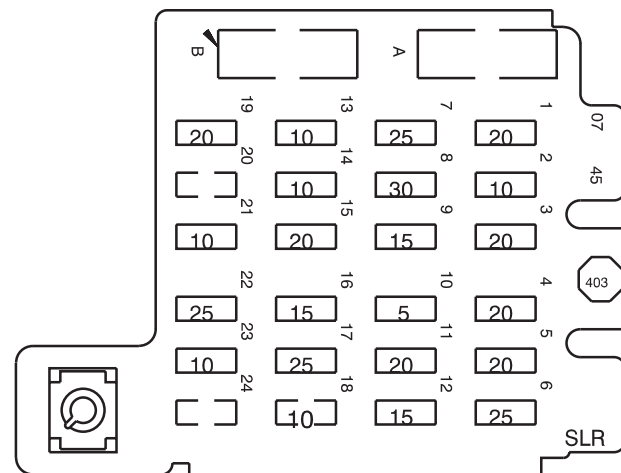

VISTA FRONTAL



Cores - Fios / Colores - Alambres / Wires - Colors

BLK = Preto Negro / Black	BRN = Marrom Marrón / Brown	BLU = Azul Azul / Blue	GRA = Cinza Gris / Gray	GRN = Verde Verde / Green	ORN = Laranja Naranja / Orange	PNK = Rosa Rosa / Pink	PPL = Violeta Violeta / Purple	RED = Vermelho Rojo / Red	TAN = Bege Beige / Tan	WHT = Branco Blanco / White	YEL = Amarelo Amarillo / Yellow	LT = Claro Claro / Light	DK = Escuro Oscuro / Dark
-------------------------------------	---------------------------------------	----------------------------------	-----------------------------------	-------------------------------------	--	----------------------------------	--	-------------------------------------	----------------------------------	---------------------------------------	---	------------------------------------	-------------------------------------

LG1

	CIRCUITO	DESCRIÇÃO
1		
2	1807	MÓDULO ABS 4WAL PINO B6
3	1601	MÓDULO IMOBILIZADOR PINO 8
4	150	MASSA
5	151	MASSA
6	448	MÓDULO ECM PINO 13
7	461	MÓDULO ECM PINO 55
8	483	PAINEL DE INSTRUMENTOS PINO 9 / MÓDULO DO ALARME PINO 21/28
9	800	MÓDULO AIR BAG PINO 05
10		
11		
12	696	MÓDULO ABS RWAL PINO D / MÓDULO DRAC PINO 10
13		
14		
15		
16	840	FUSÍVEL 7 (25A)

LPB

	CIRCUITO	DESCRIÇÃO
1		
2	1807 C	MÓDULO ABS 4WAL PINO B6
3		
4	150 N	MASSA
5	151 J	MASSA
6		
7	1461	MÓDULO IMOBILIZADOR PINO 06
8	483	PAINEL DE INSTRUMENTOS PINO 9 / MÓDULO DO ALARME PINO 21/28
9	800 G	MÓDULO AIR BAG PINO 05
10		
11		
12	696 B	MÓDULO ABS RWAL PINO D / MÓDULO DRAC PINO 10
13		
14		
15		
16	840	FUSÍVEL 7 (25A)

LG3

	CIRCUITO	DESCRIÇÃO
1		
2	1807/799	MÓDULO ABS PINO B6 / MÓDULO IMOBILIZADOR PINO 7 / PCM PINO 5J1-58 & J1-59
3	1601	MÓDULO IMOBILIZADOR PINO 8
4	150	MASSA
5	151	MASSA
6		
7		
8	483	PAINEL DE INSTRUMENTOS PINO 9 / MÓDULO ALARME PINO 21/28
9	800	MÓDULO AIRBAG PINO 5
10		
11		
12	696	MÓDULO ABS PINO D / MÓDULO ABS 4WAL PINO B1 / PCM PINO J2-49
13	1568	MÓDULO 4X4 PINO D3
14		
15		
16	840	FUSÍVEL 7 (25A)

LLK

	CIRCUITO	DESCRIÇÃO
1		
2	1807	MÓDULO ABS 4WAL PINO B6
3	1601	MÓDULO IMOBILIZADOR PINO 8
4	150	MASSA
5	151	MASSA
6		
7	448	MÓDULO ECM PINO 25
8	483	PAINEL DE INSTRUMENTOS PINO 9 / MÓDULO DO ALARME PINO 21/28
9	800	MÓDULO AIR BAG PINO 05
10		
11		
12	696	MÓDULO ABS RWAL PINO D / MÓDULO DRAC PINO 10
13	1568	MÓDULO 4X4 PINO D3
14		
15		
16	840	FUSÍVEL 7 (25A)



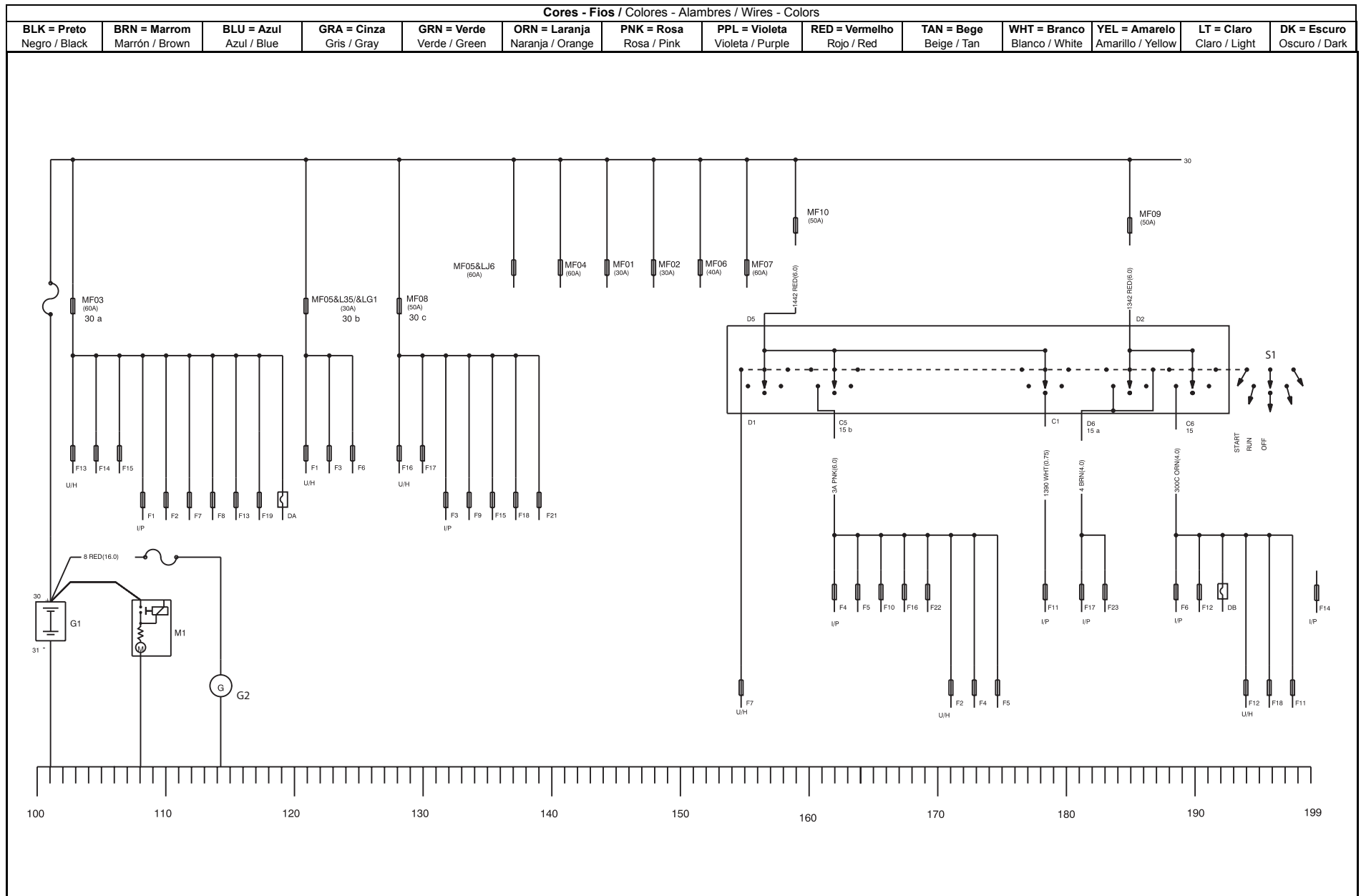

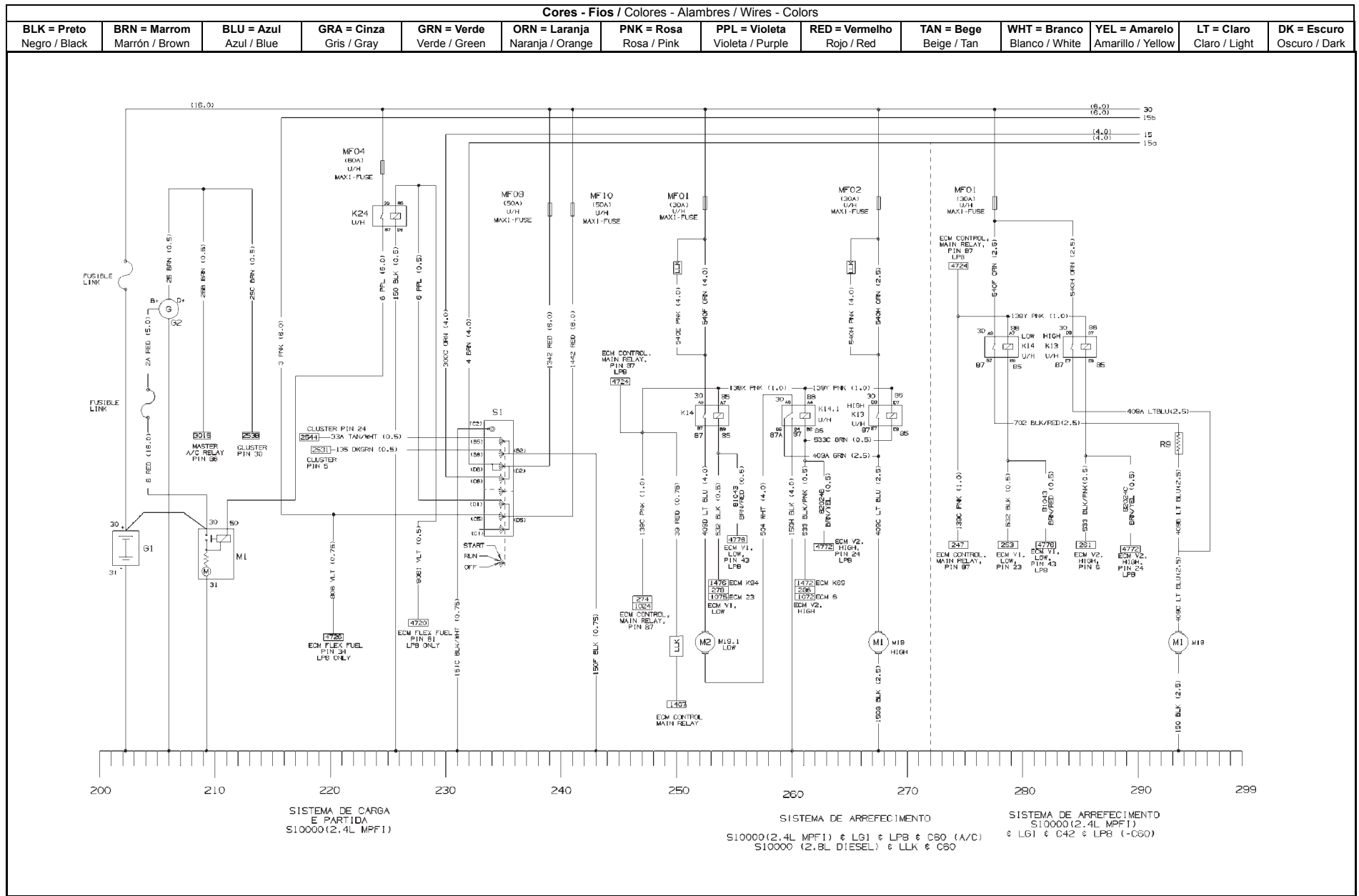

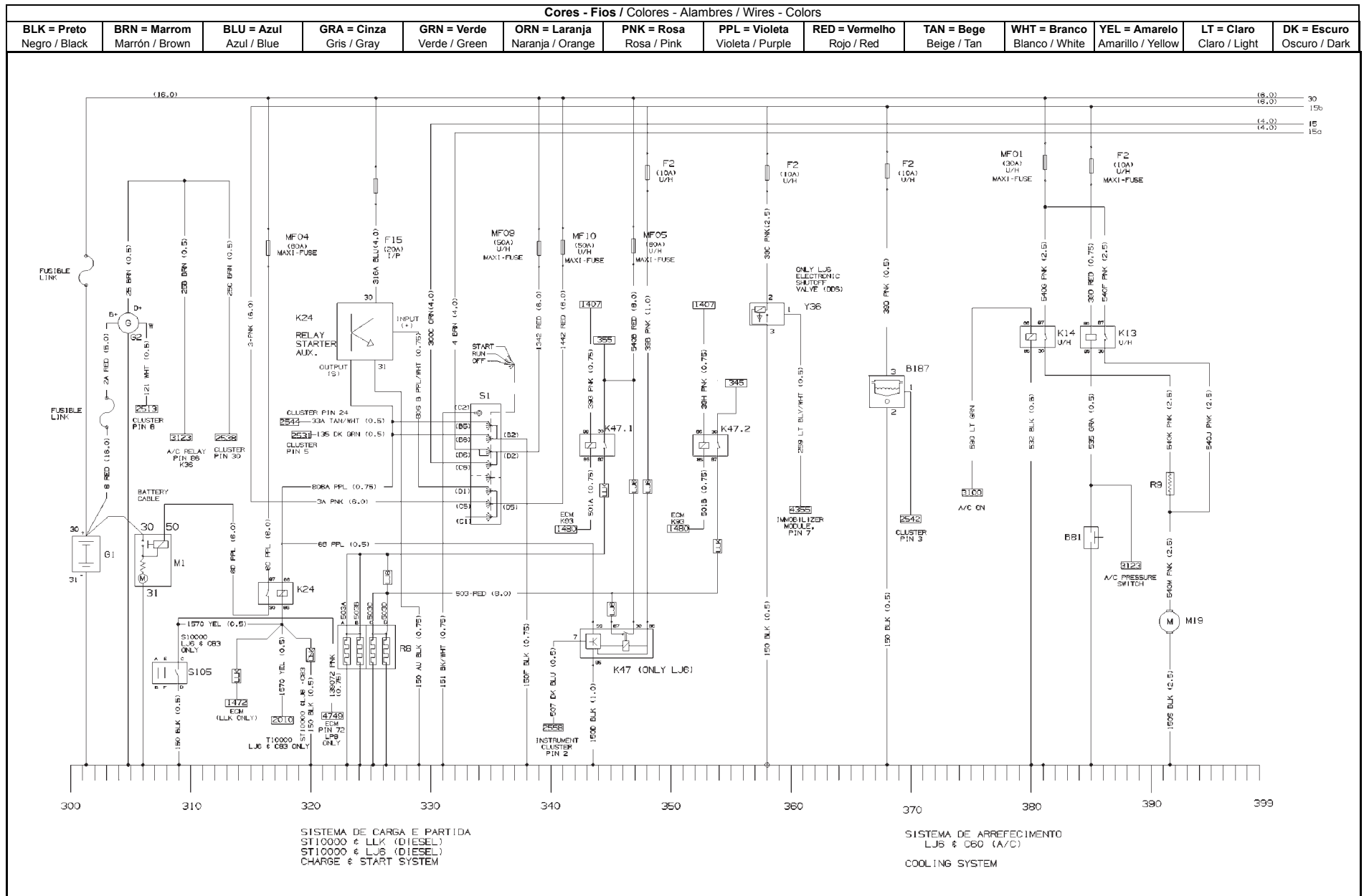

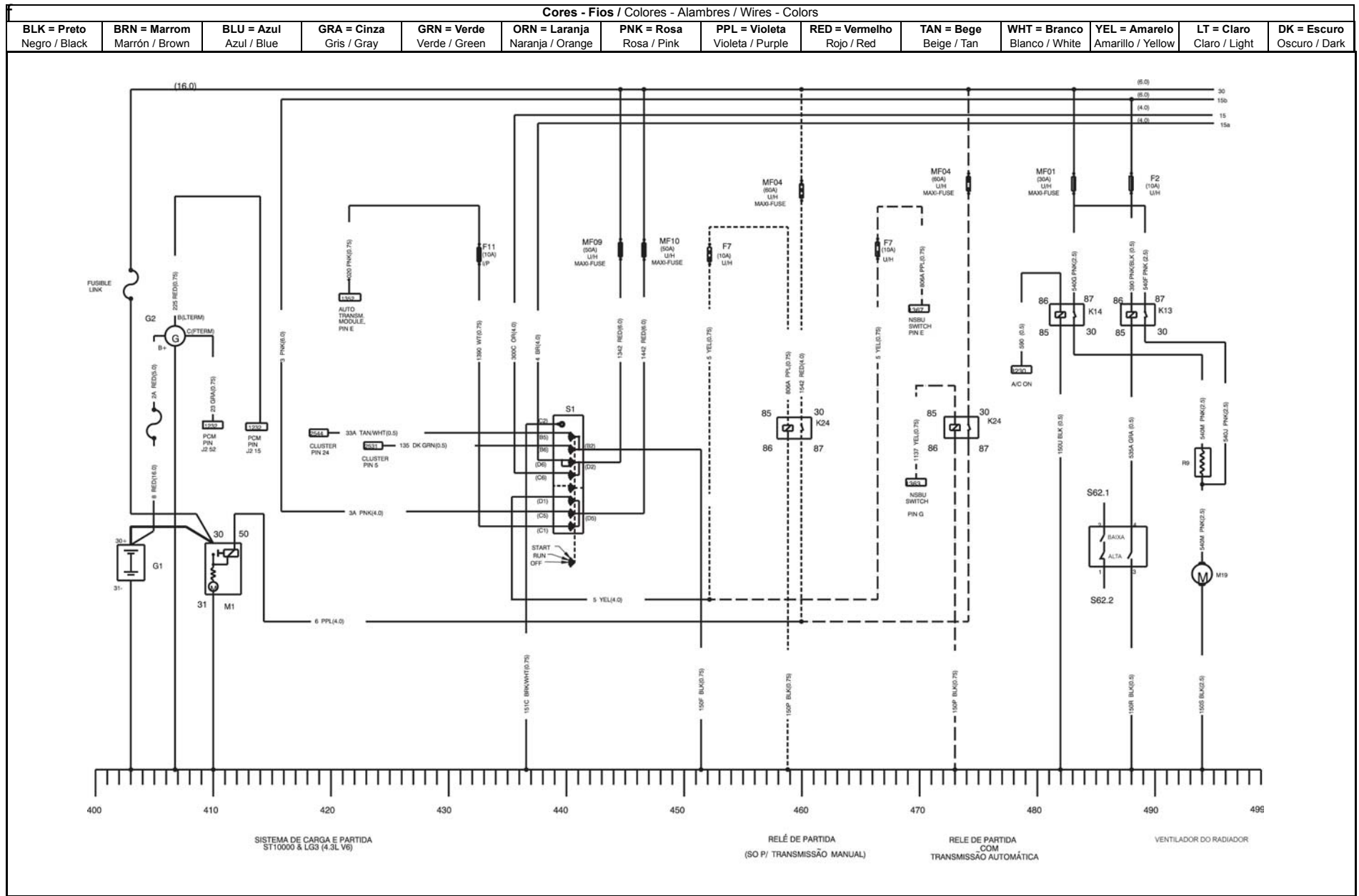

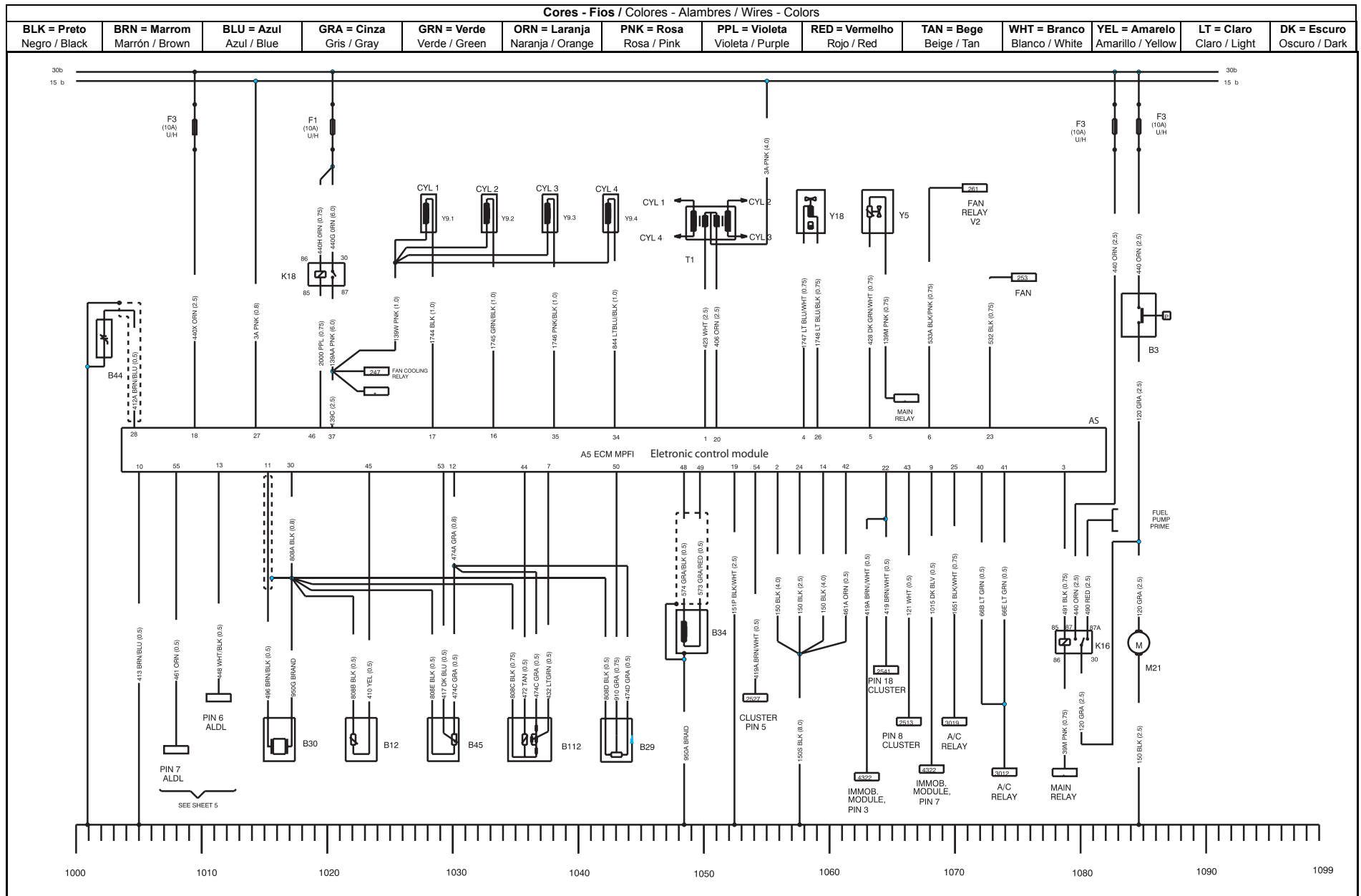

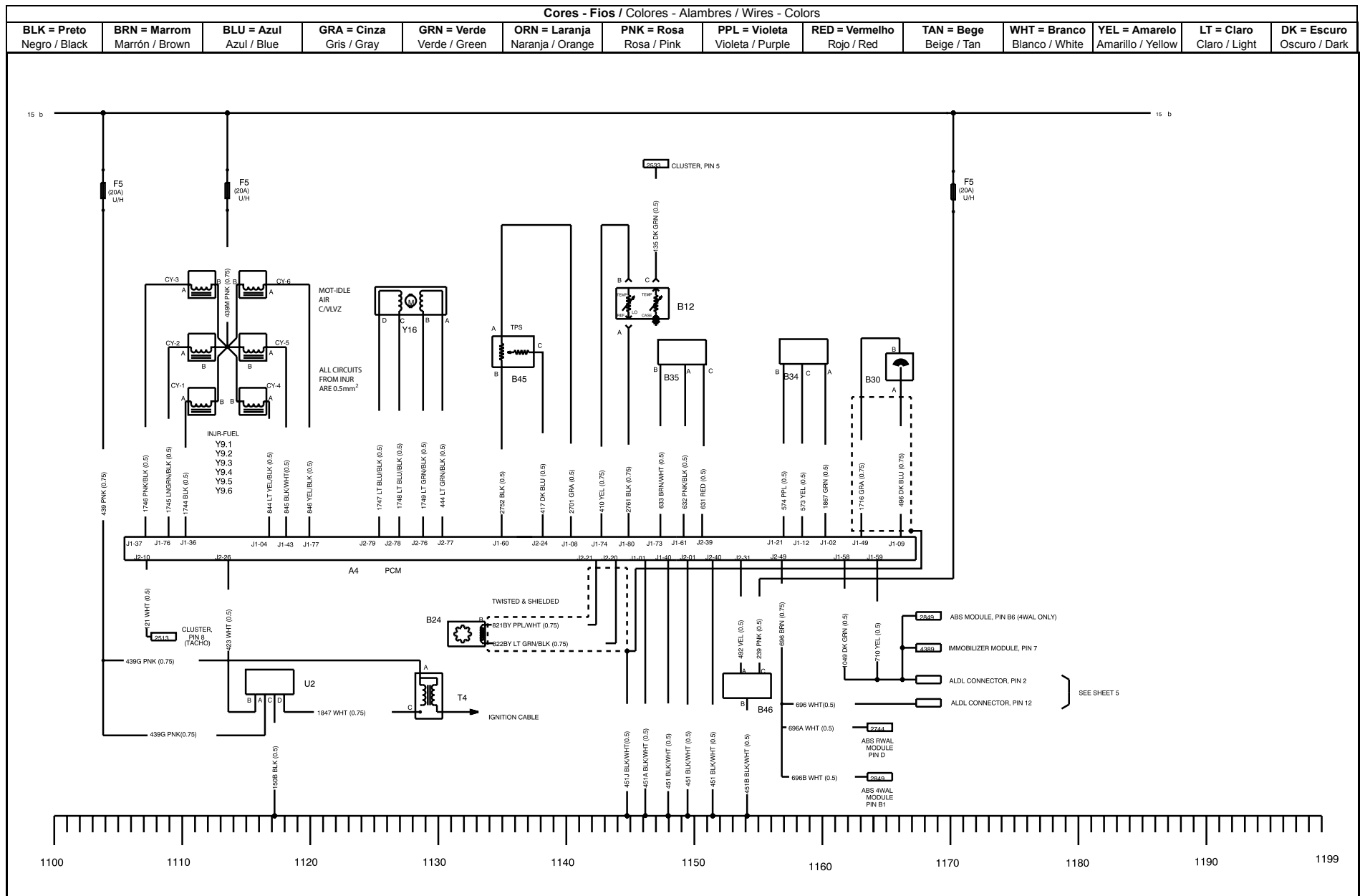

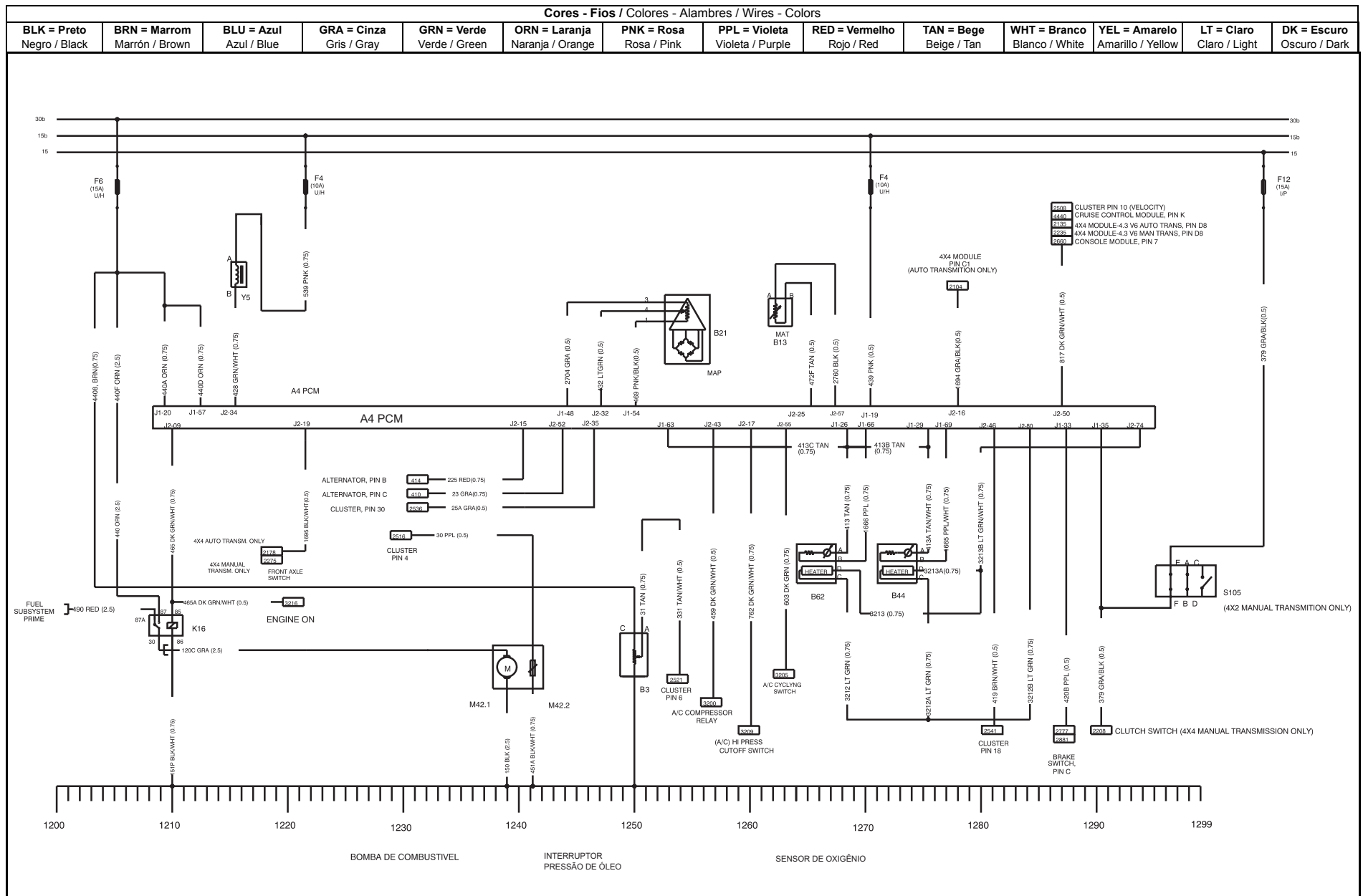

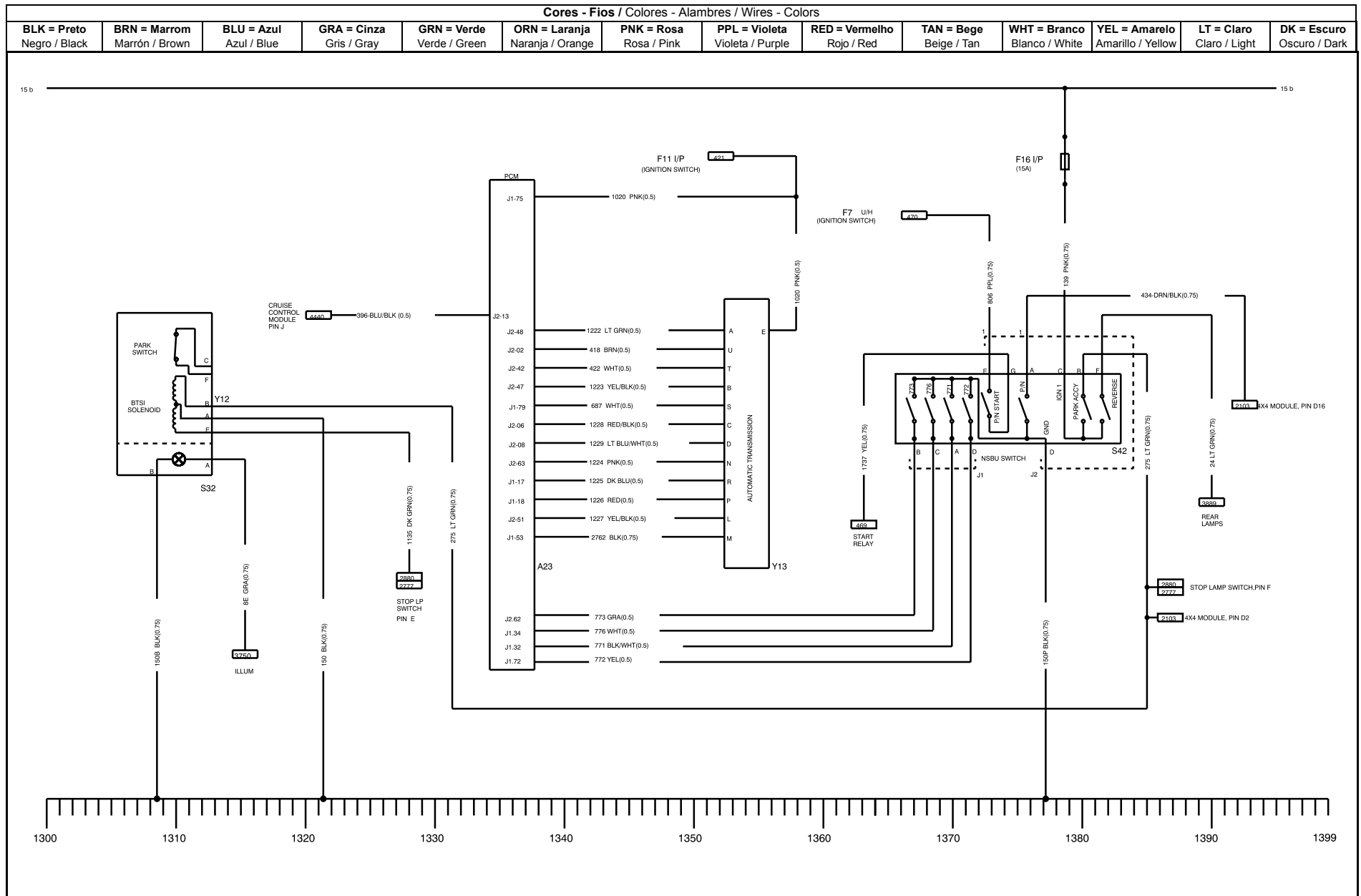

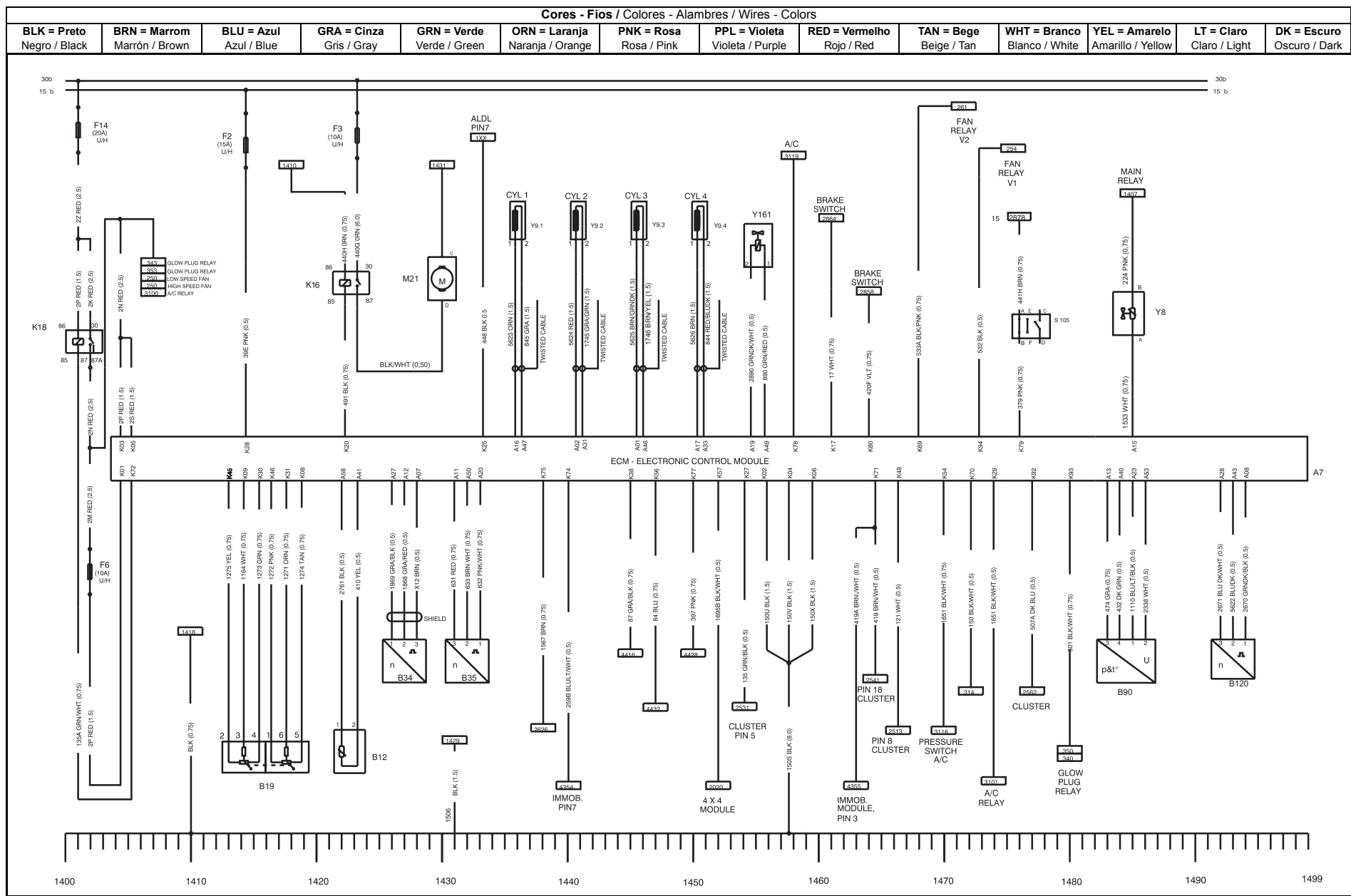

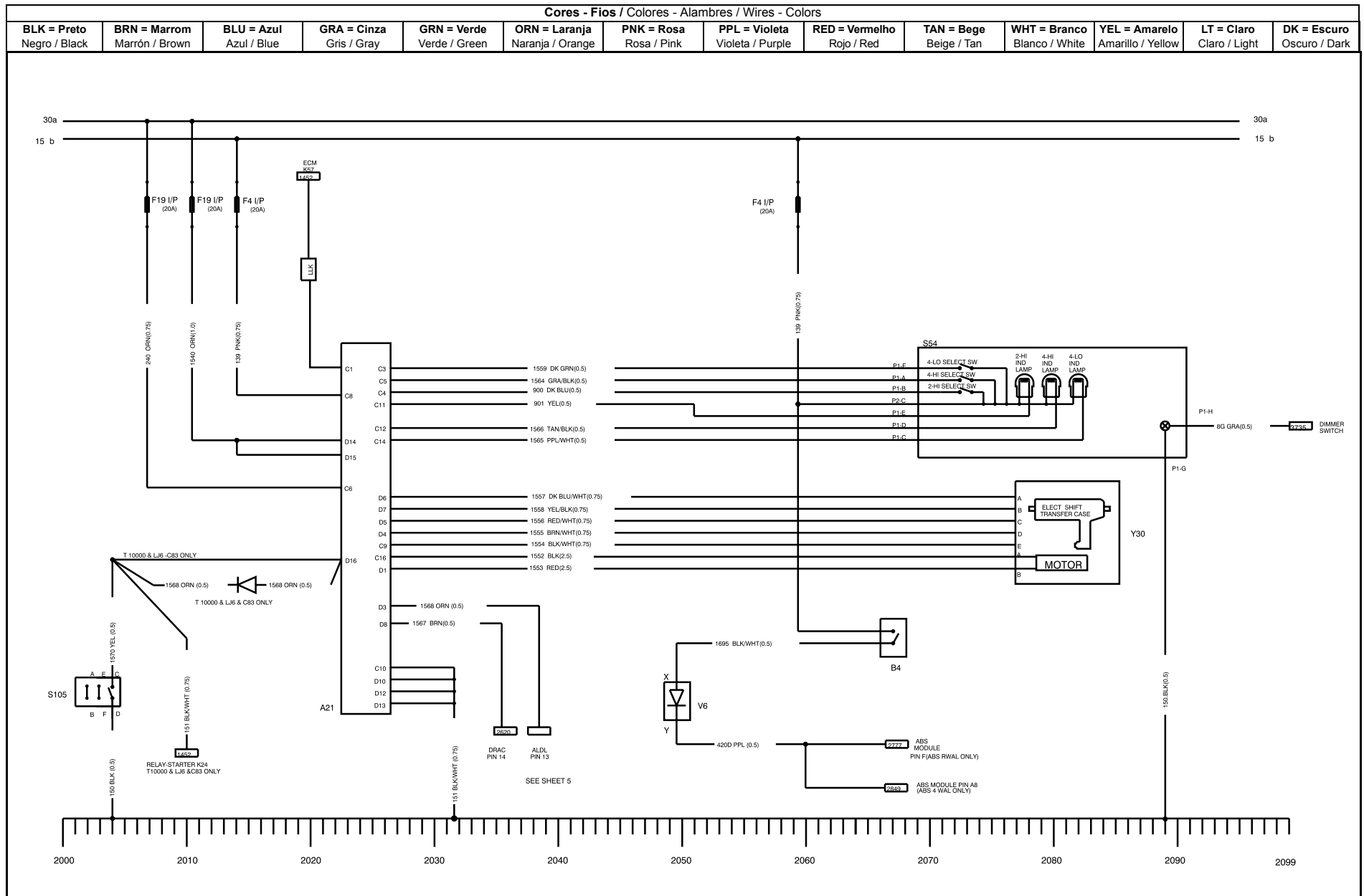

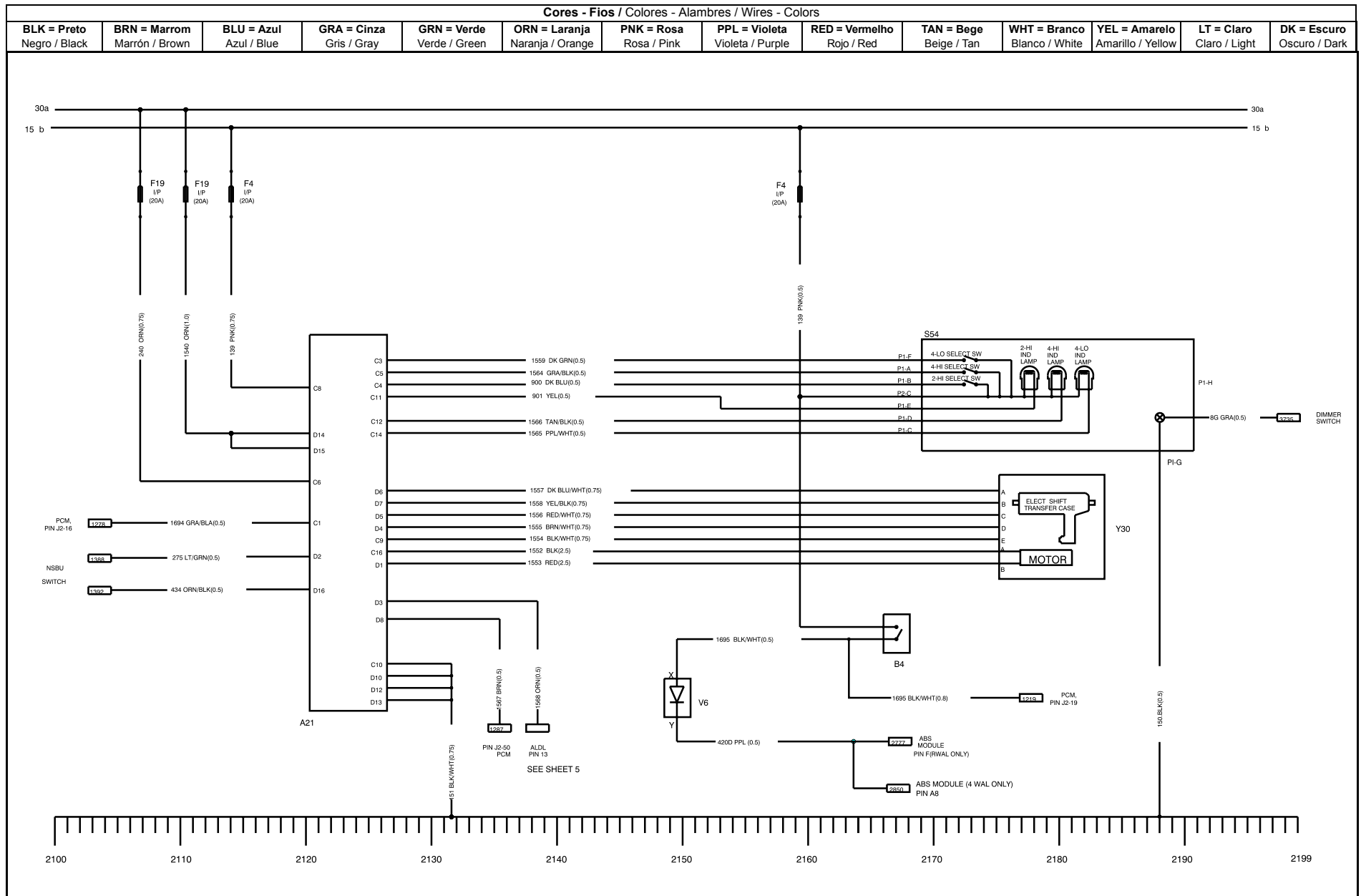

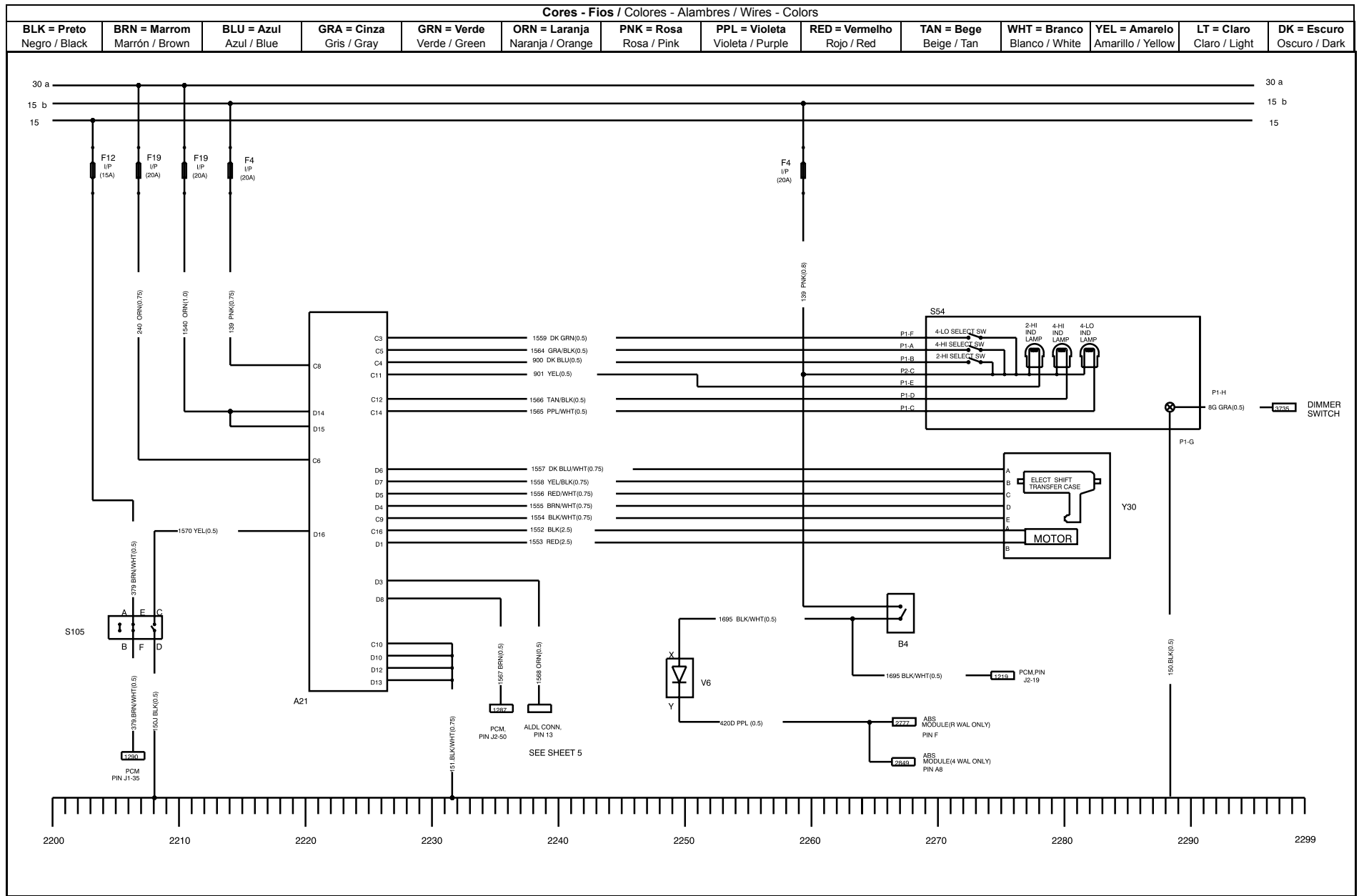

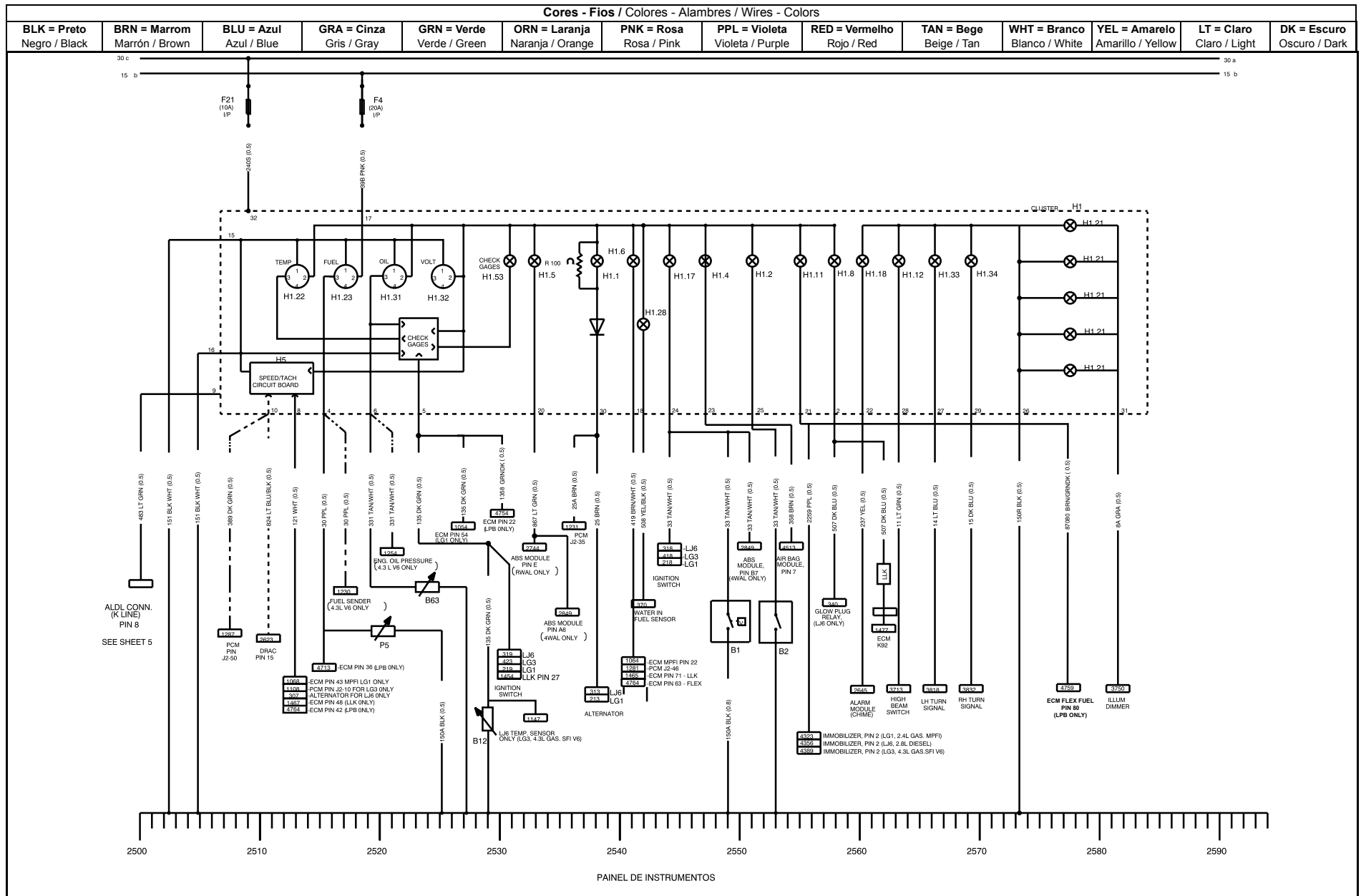

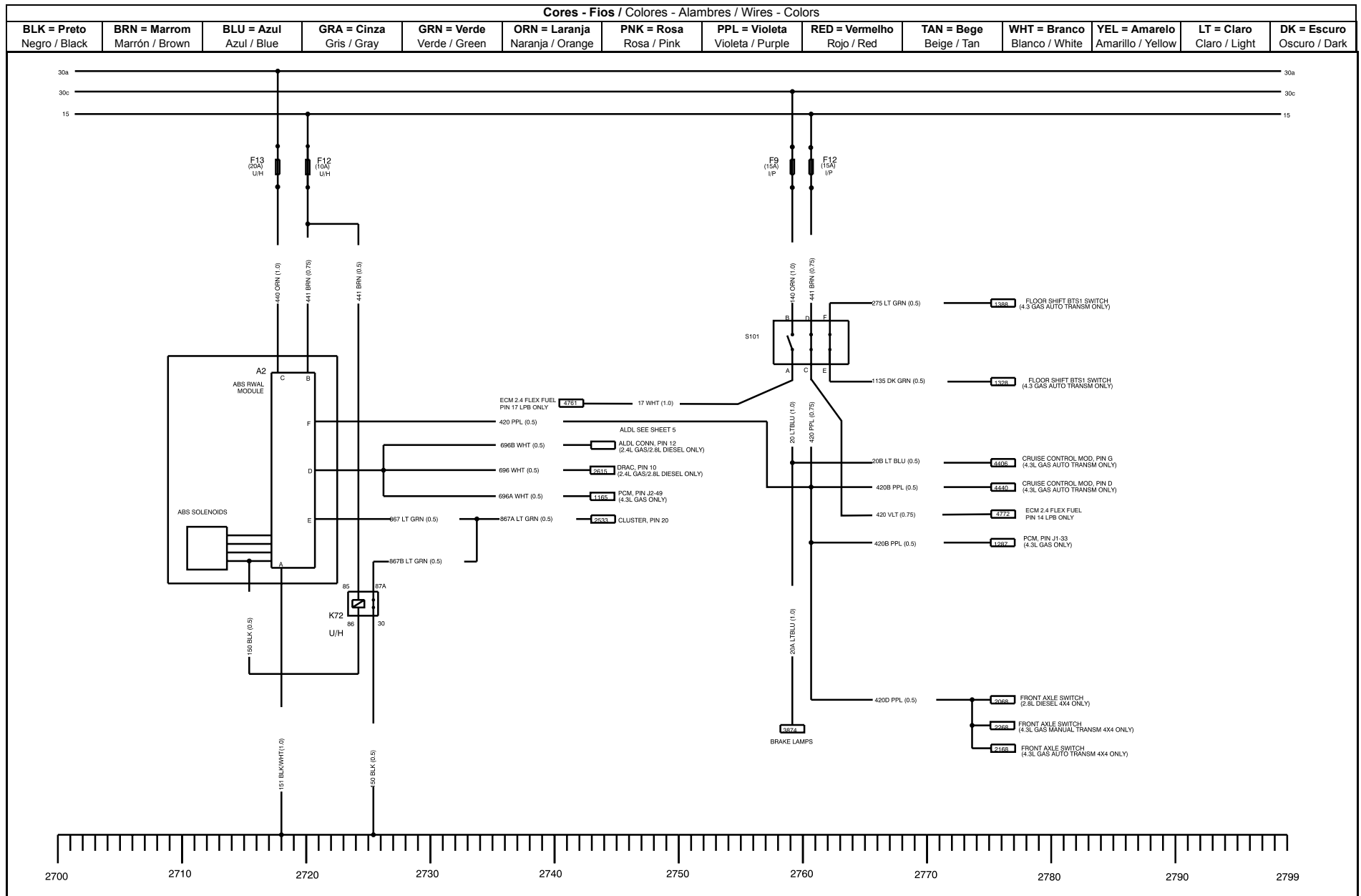

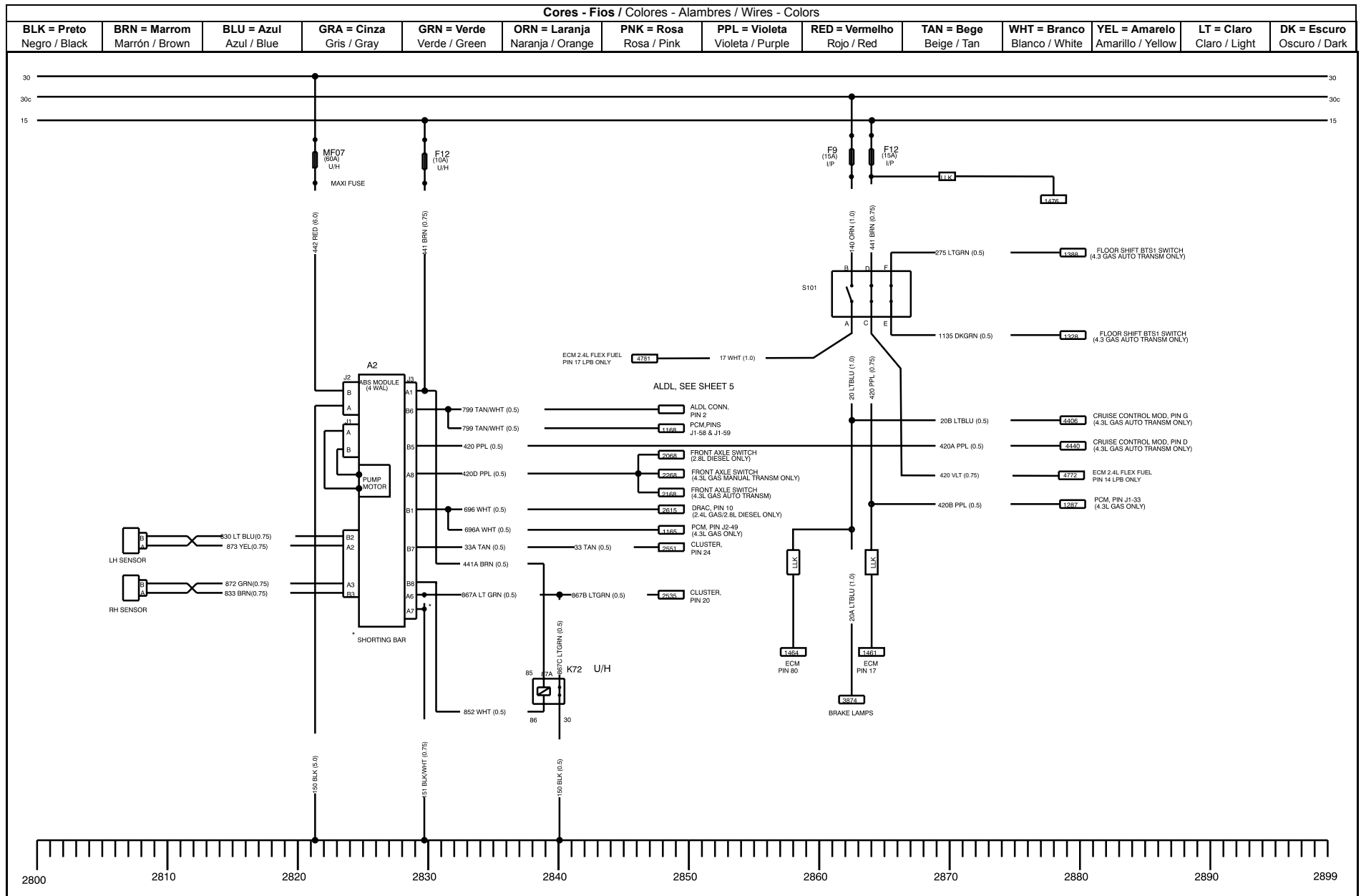

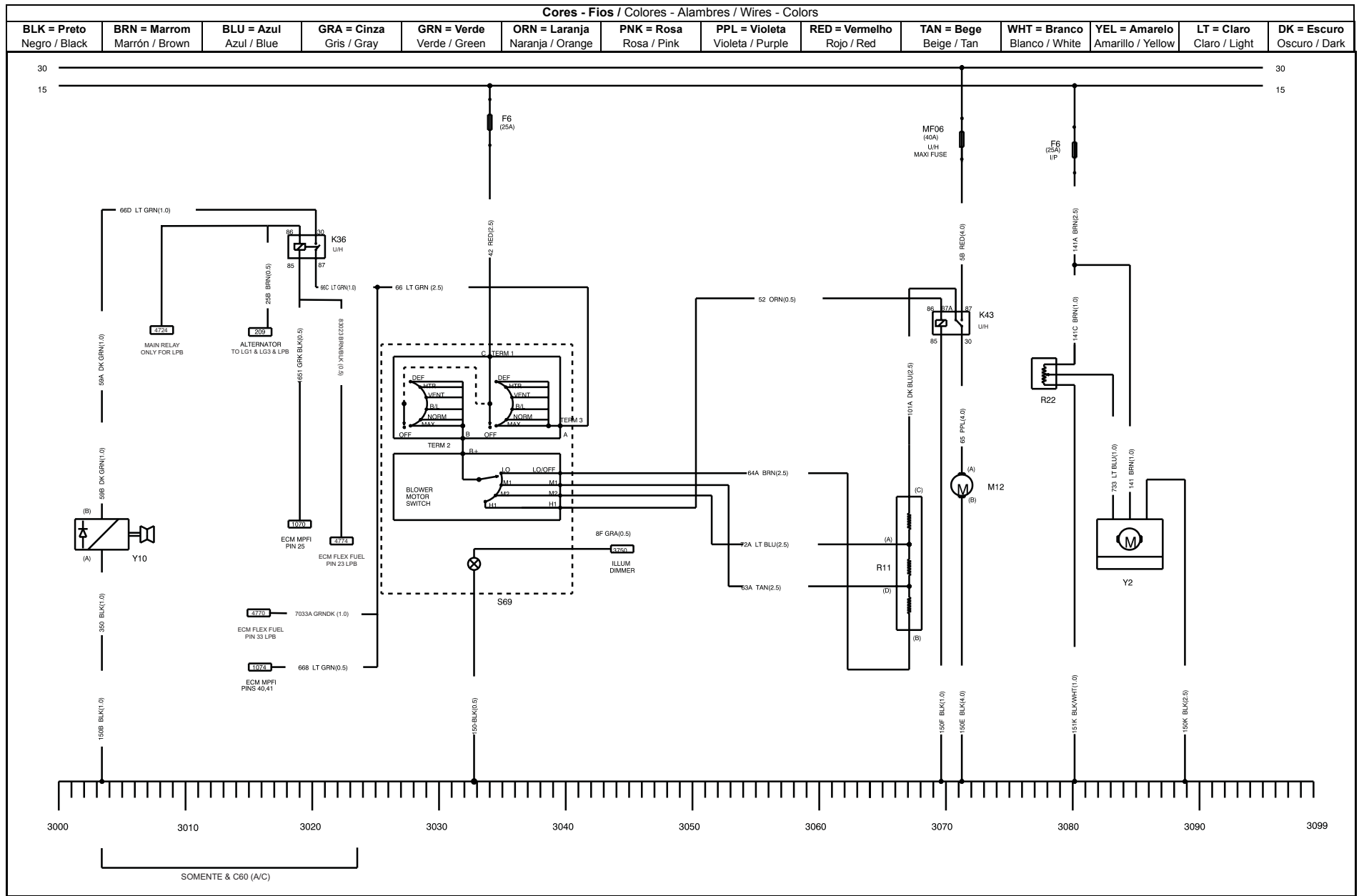

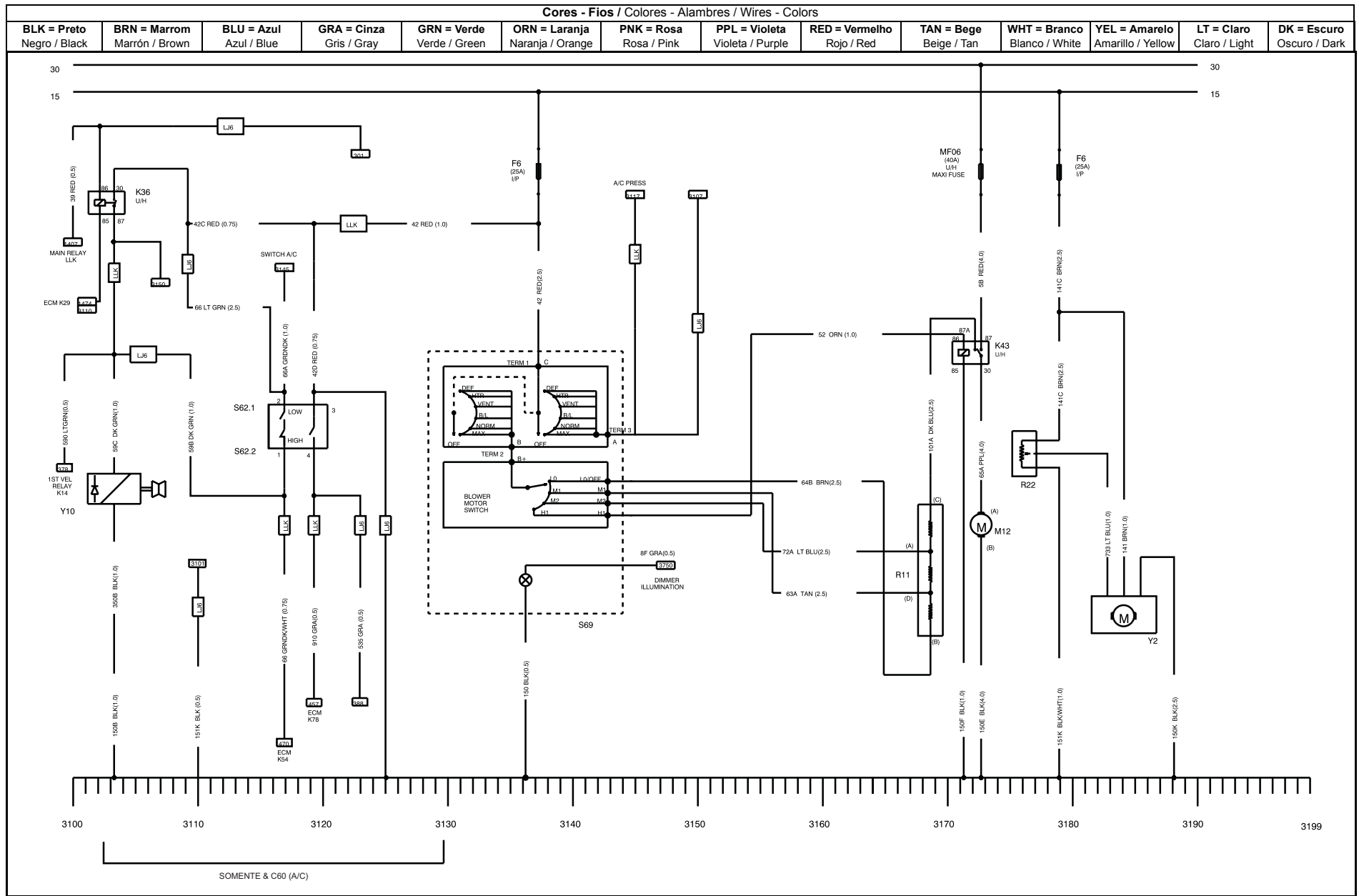

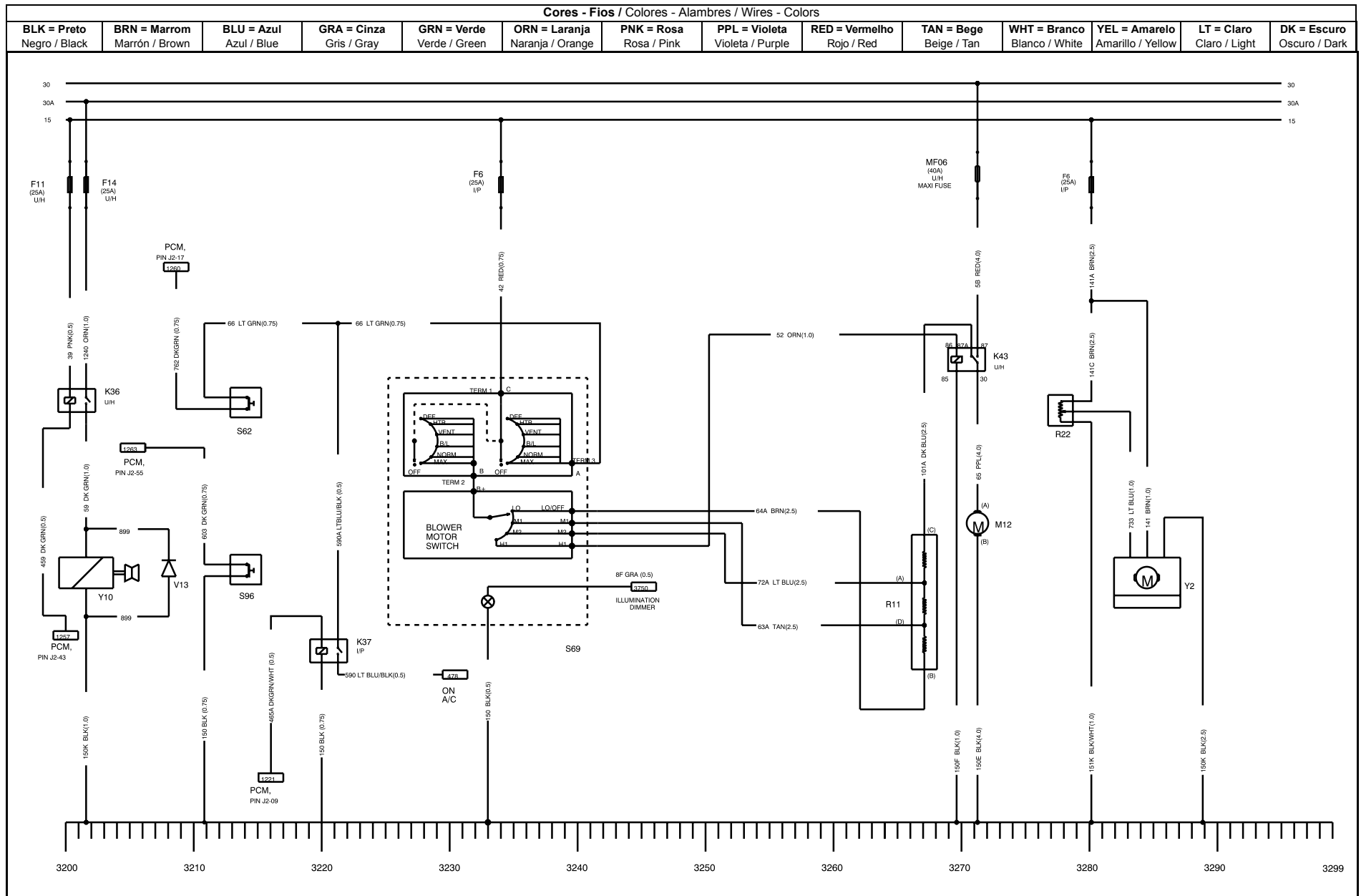

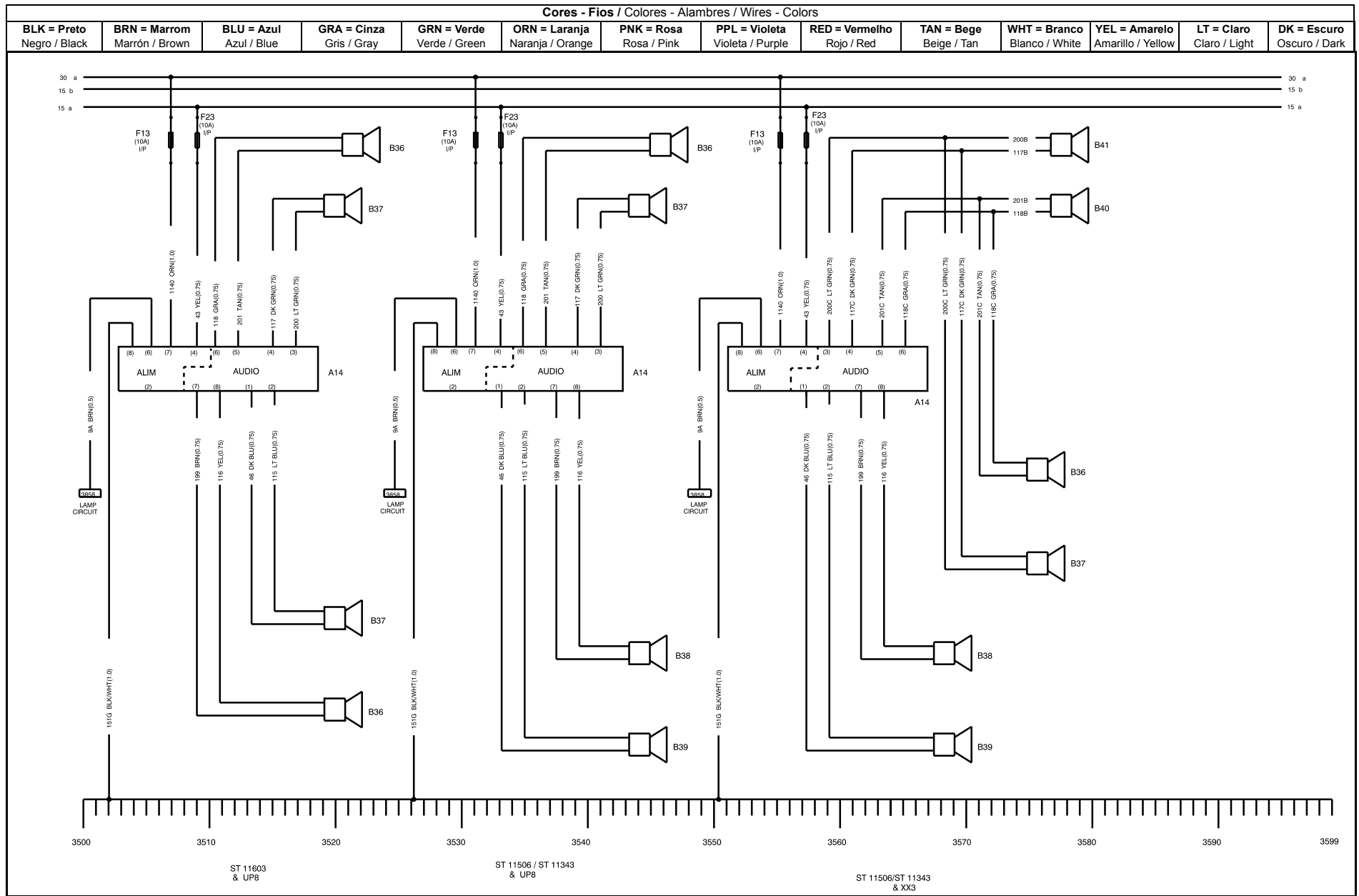

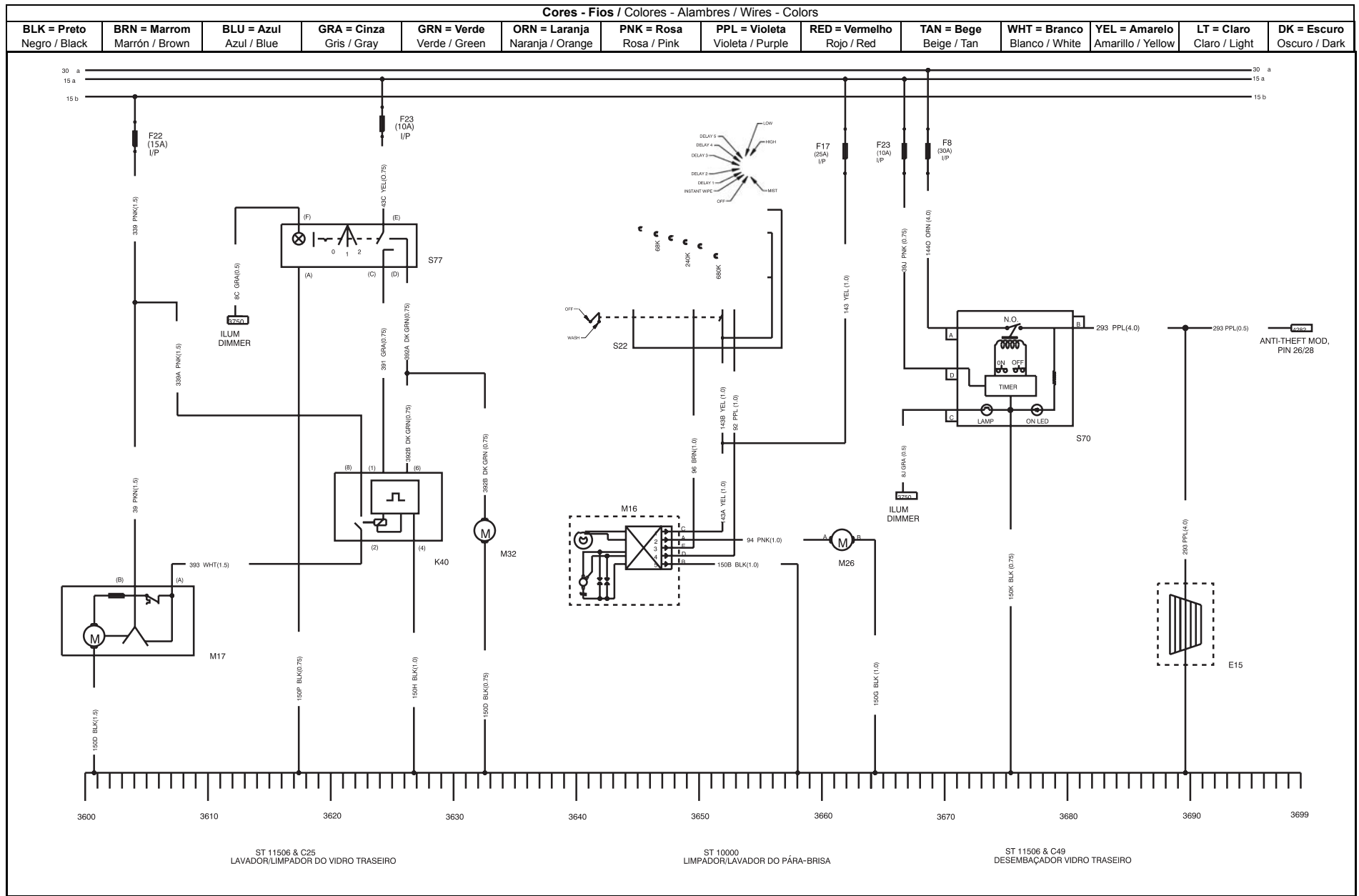

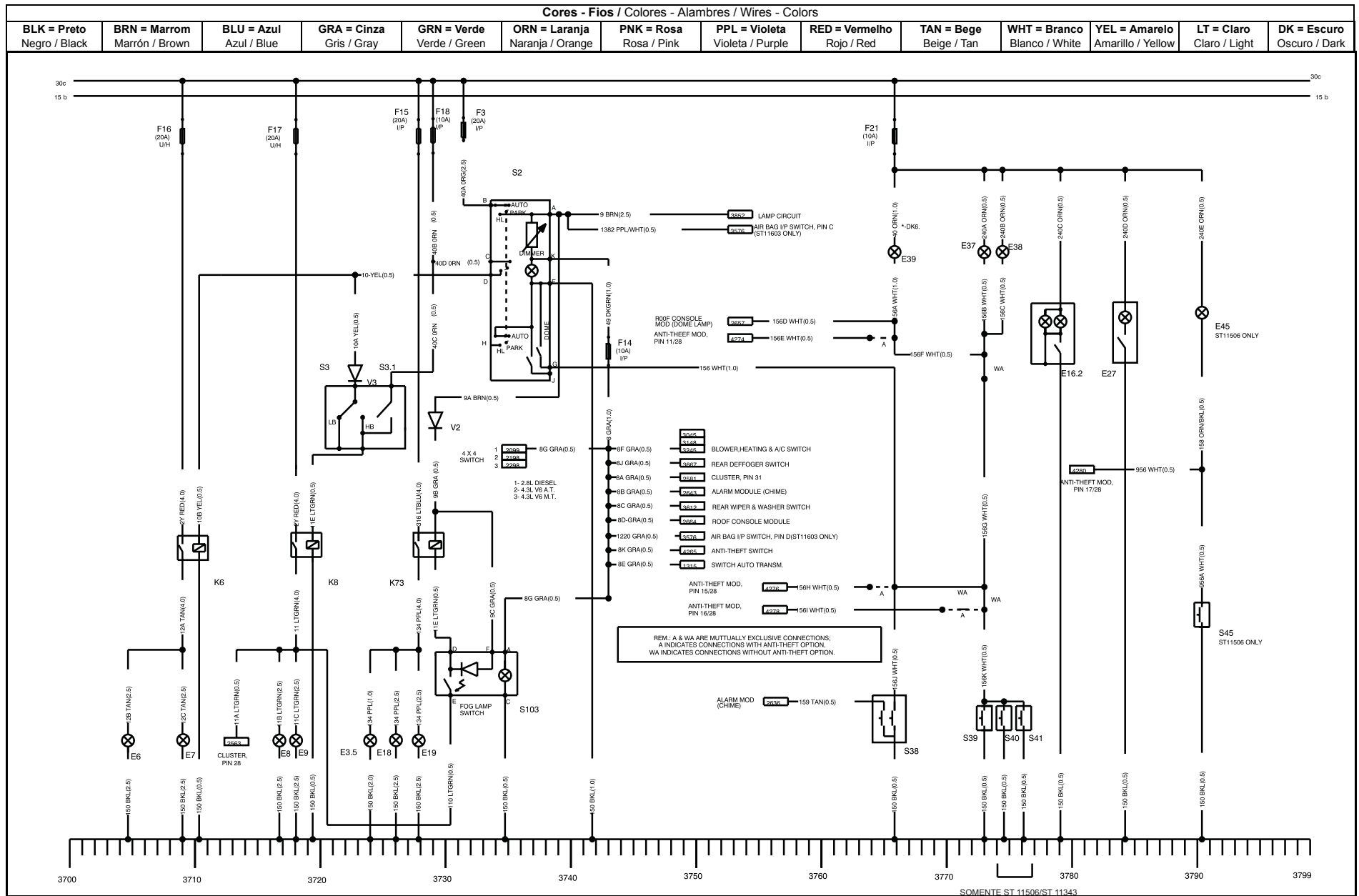

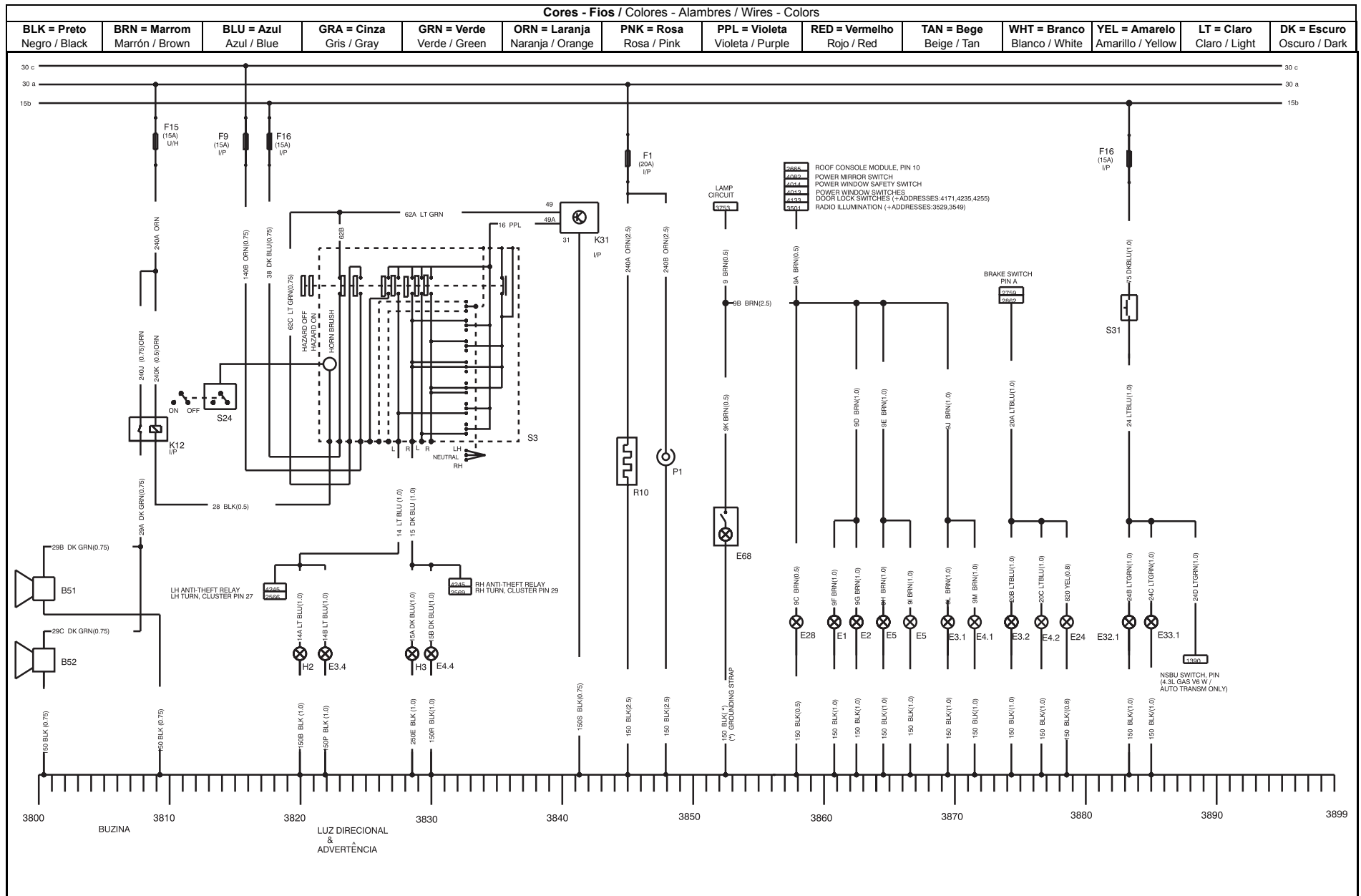

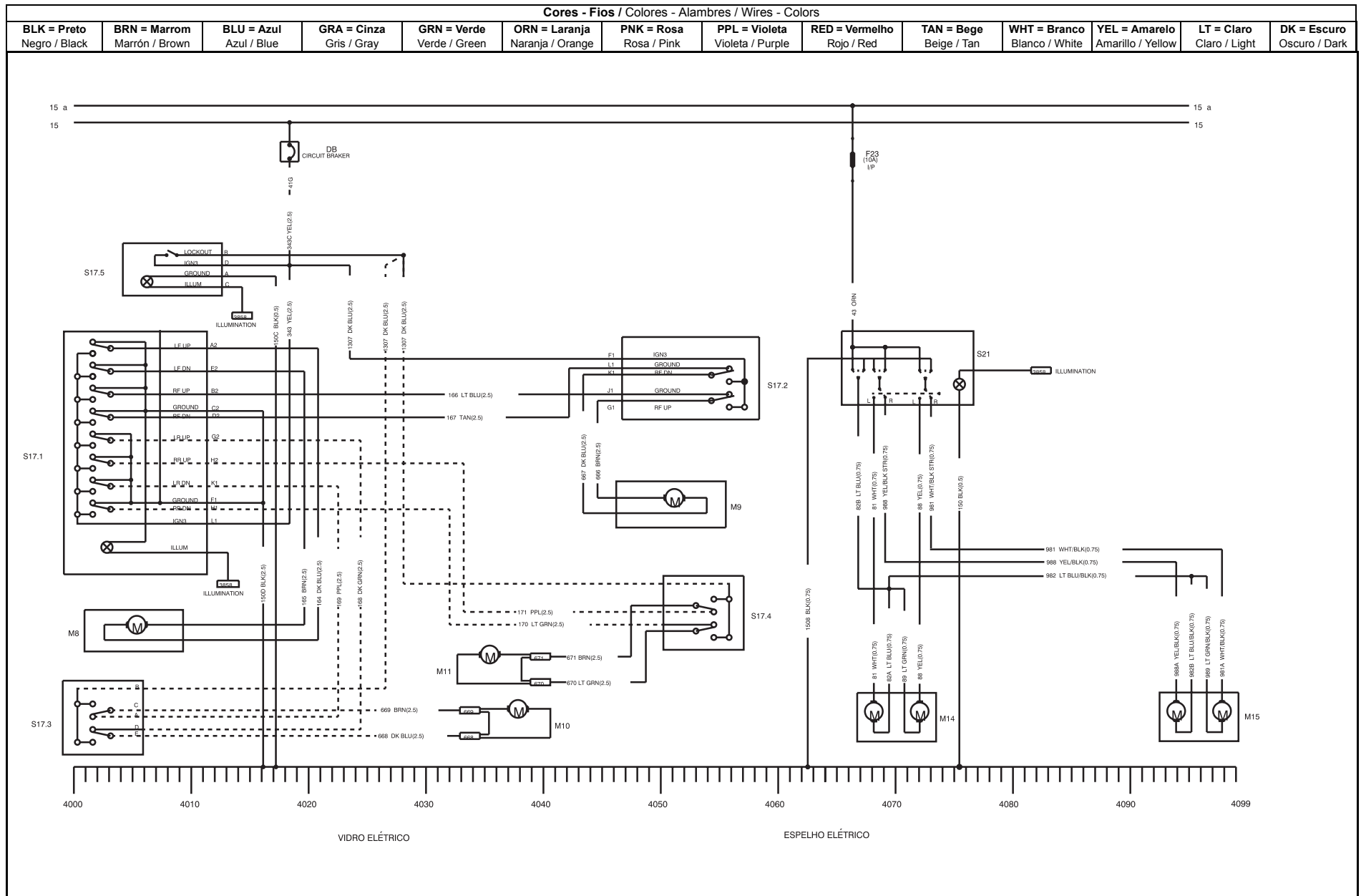

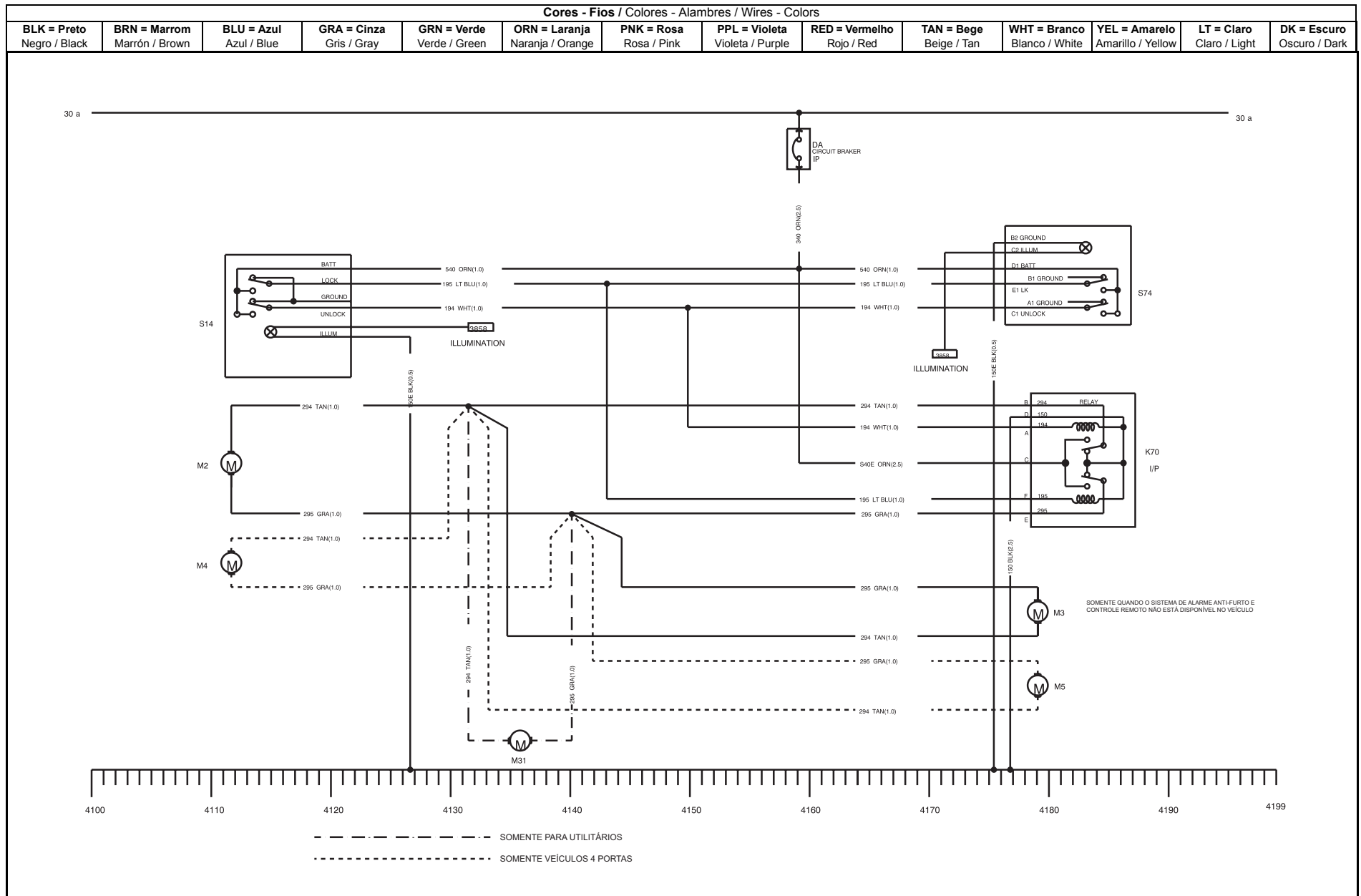

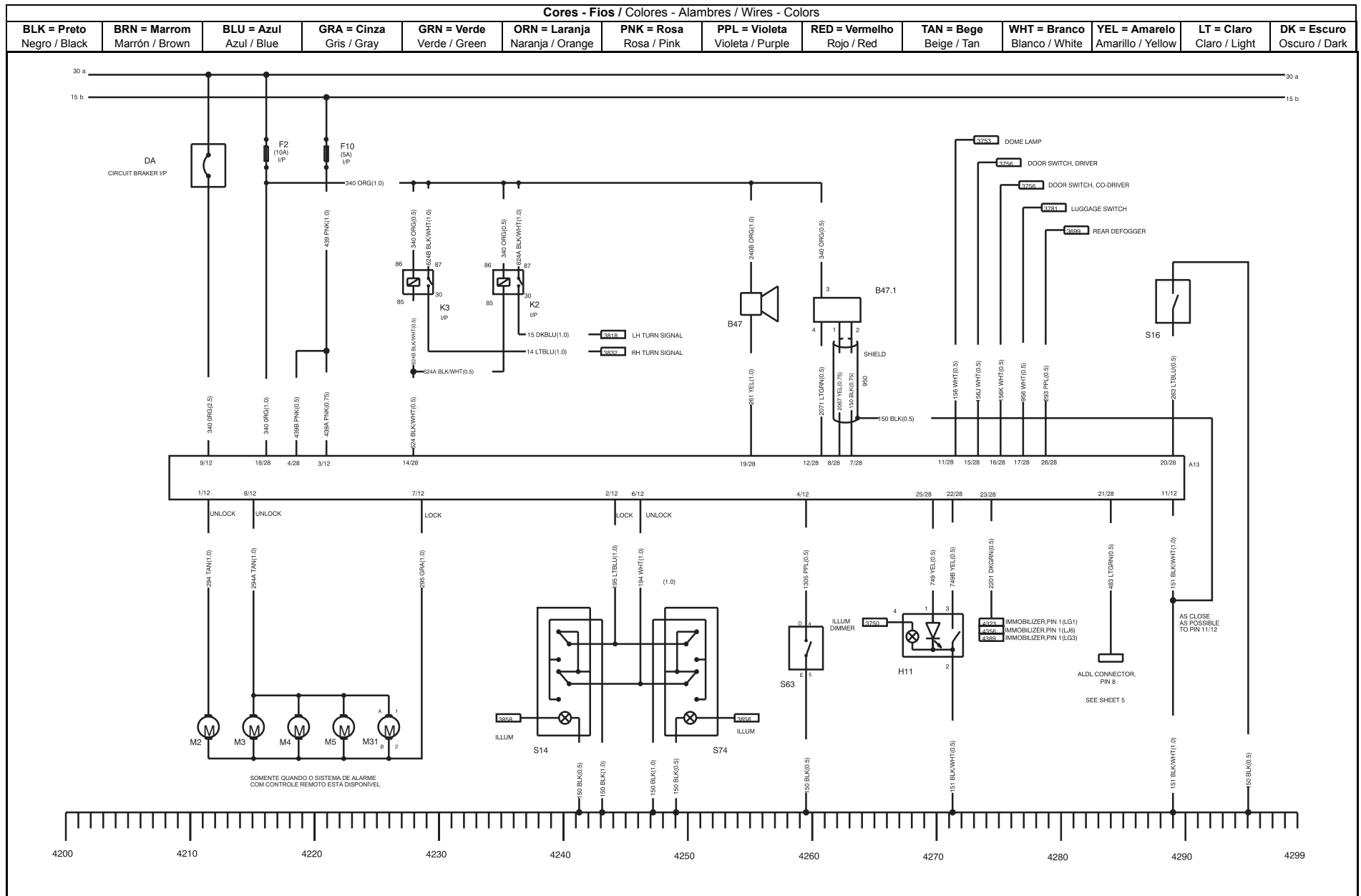

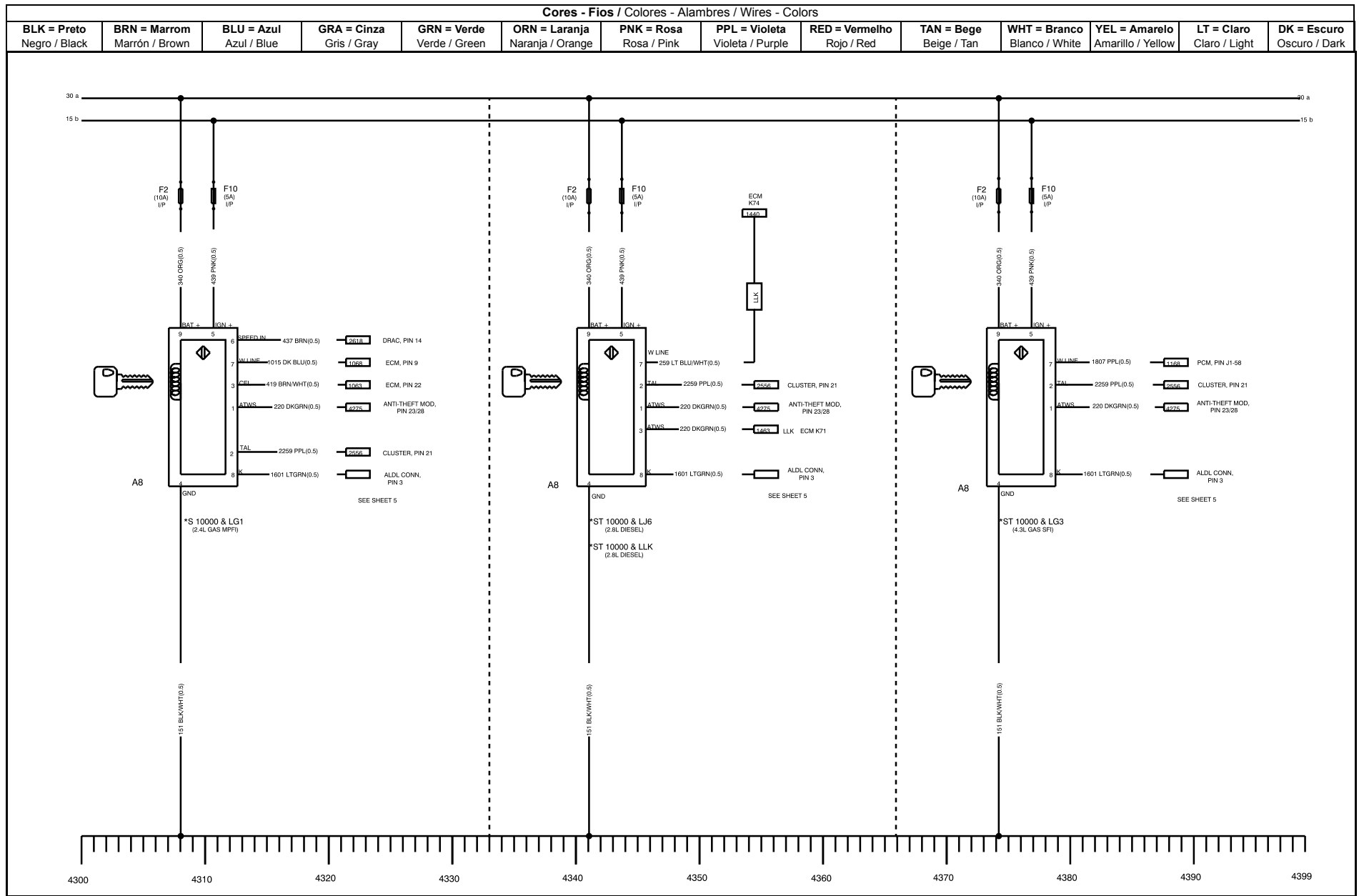

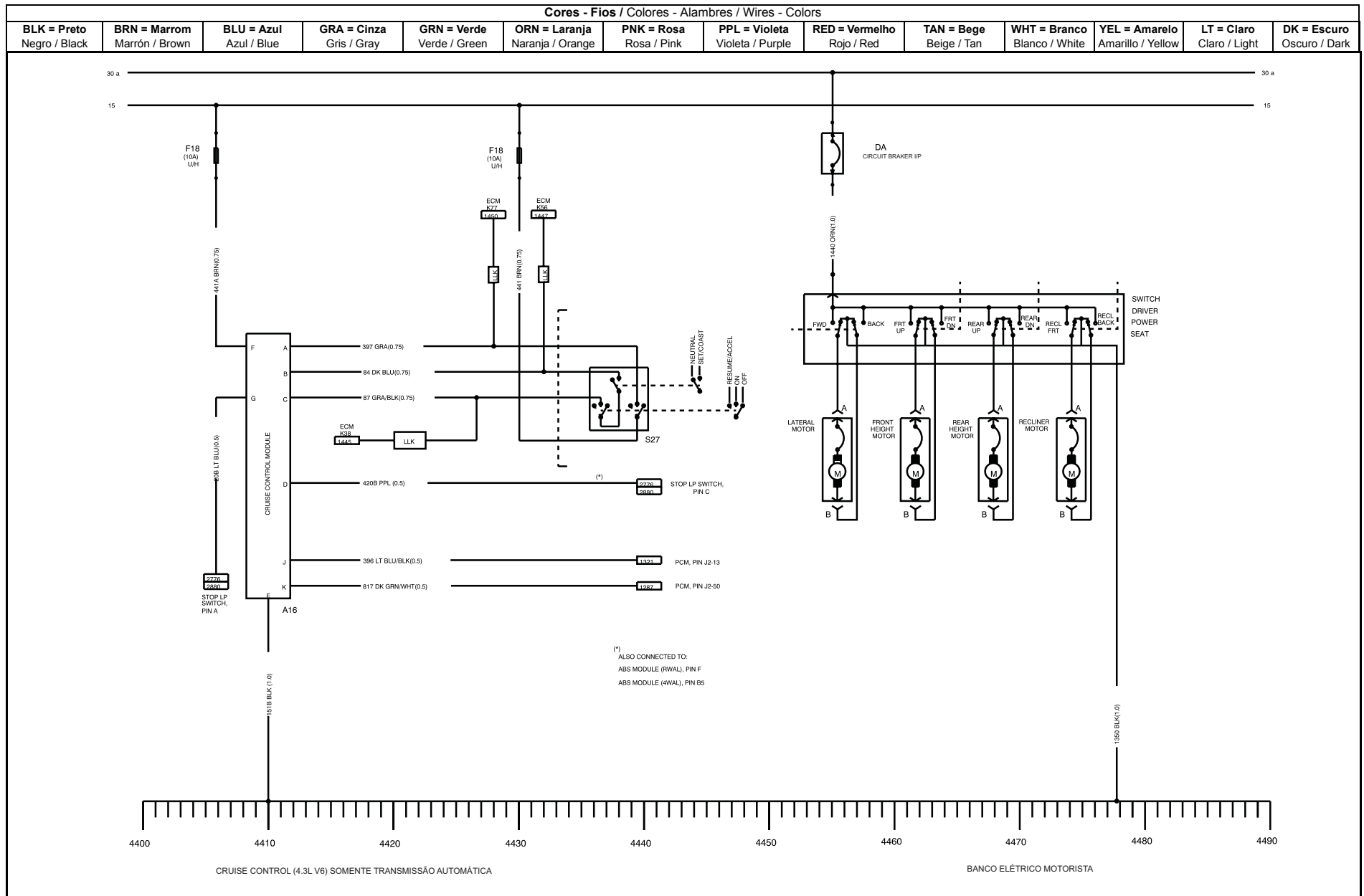

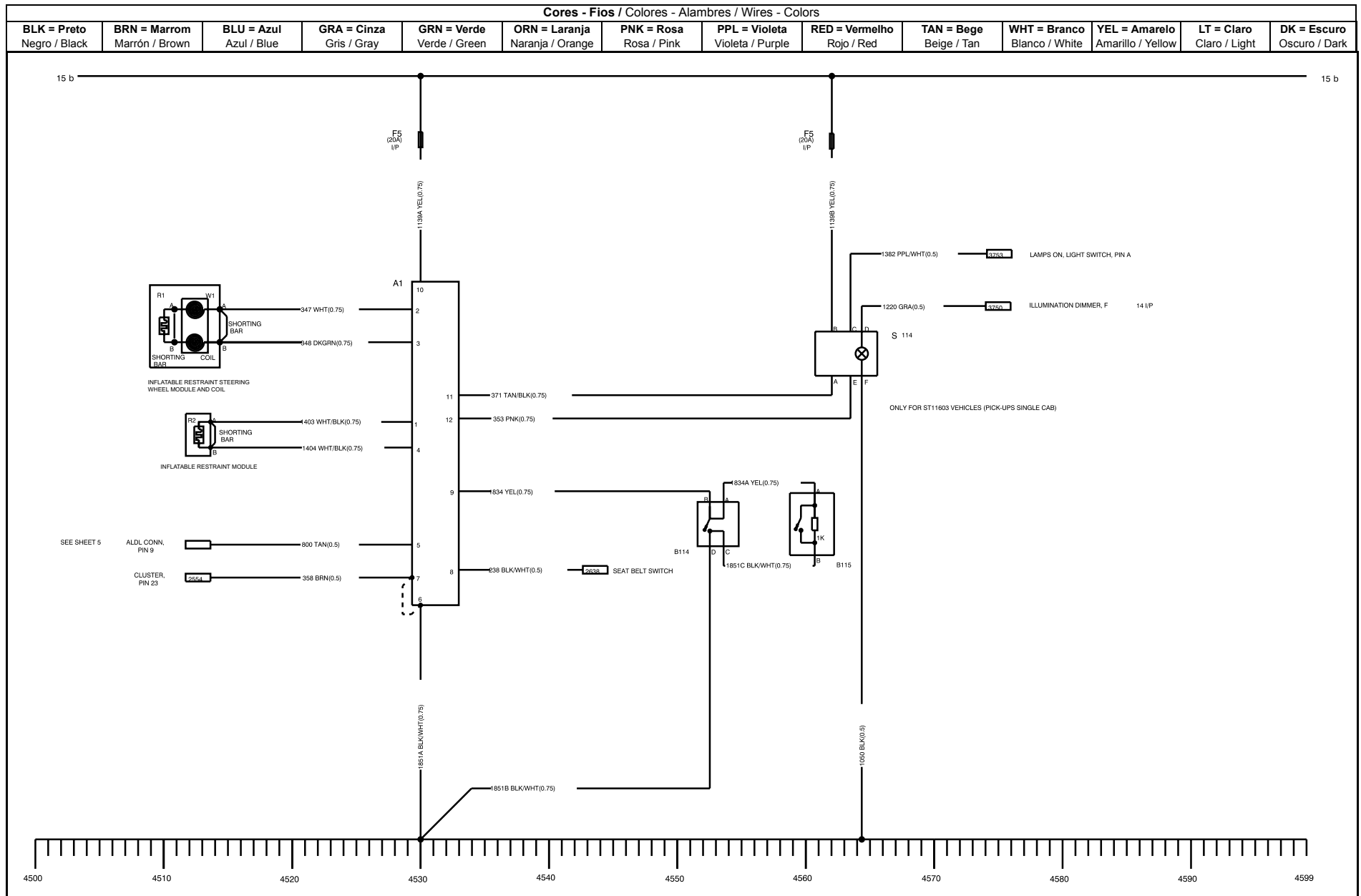

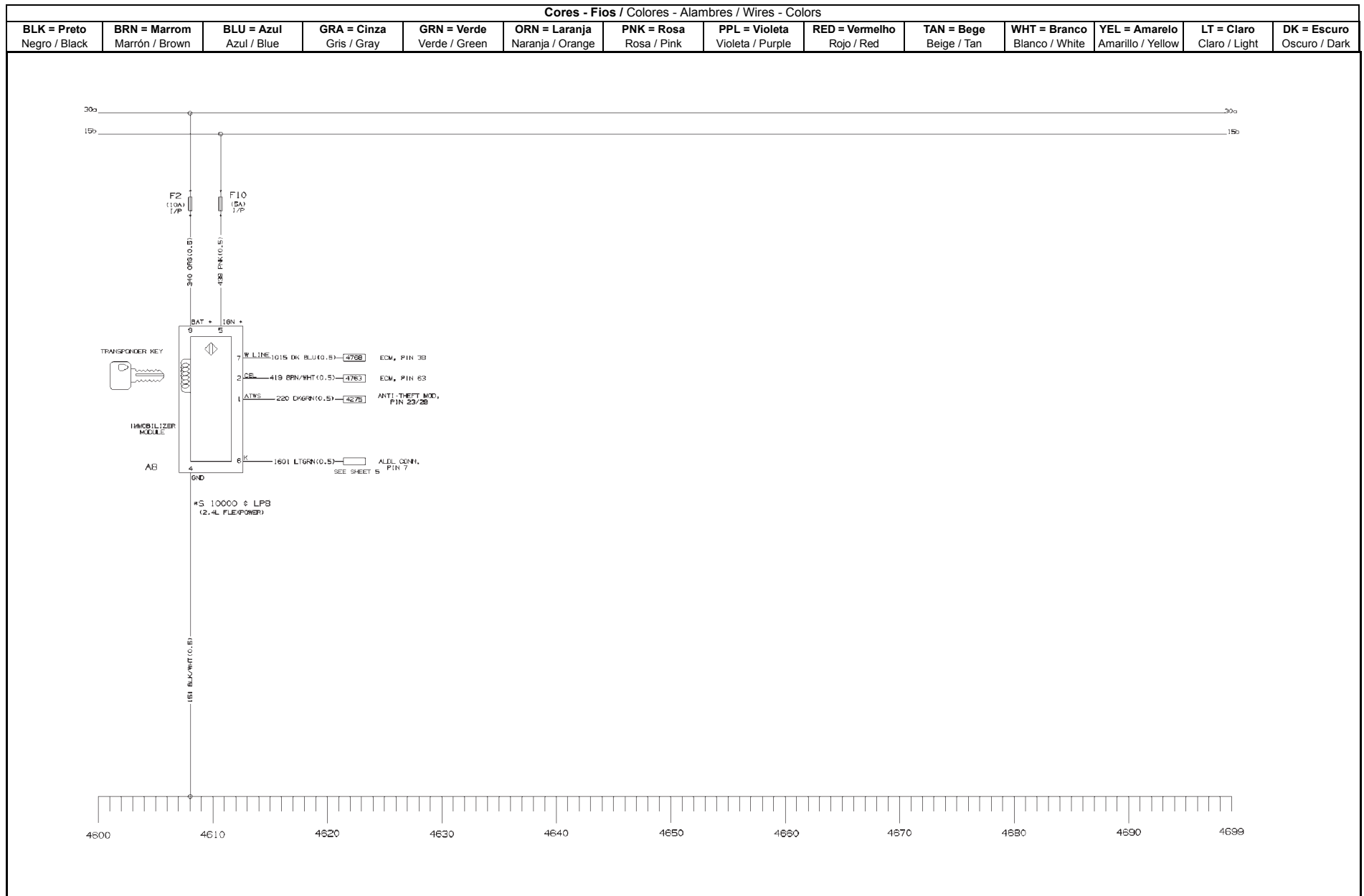

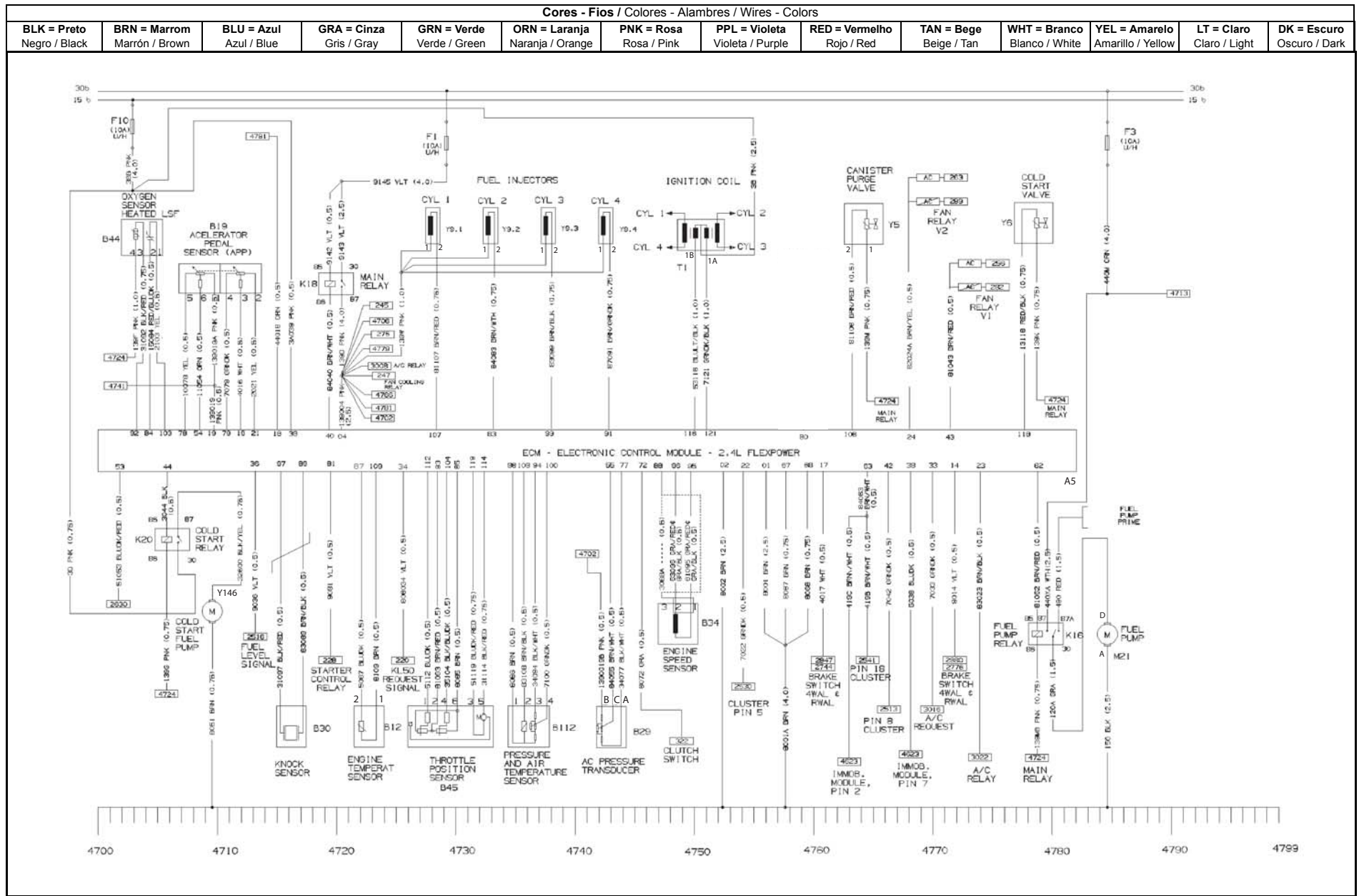

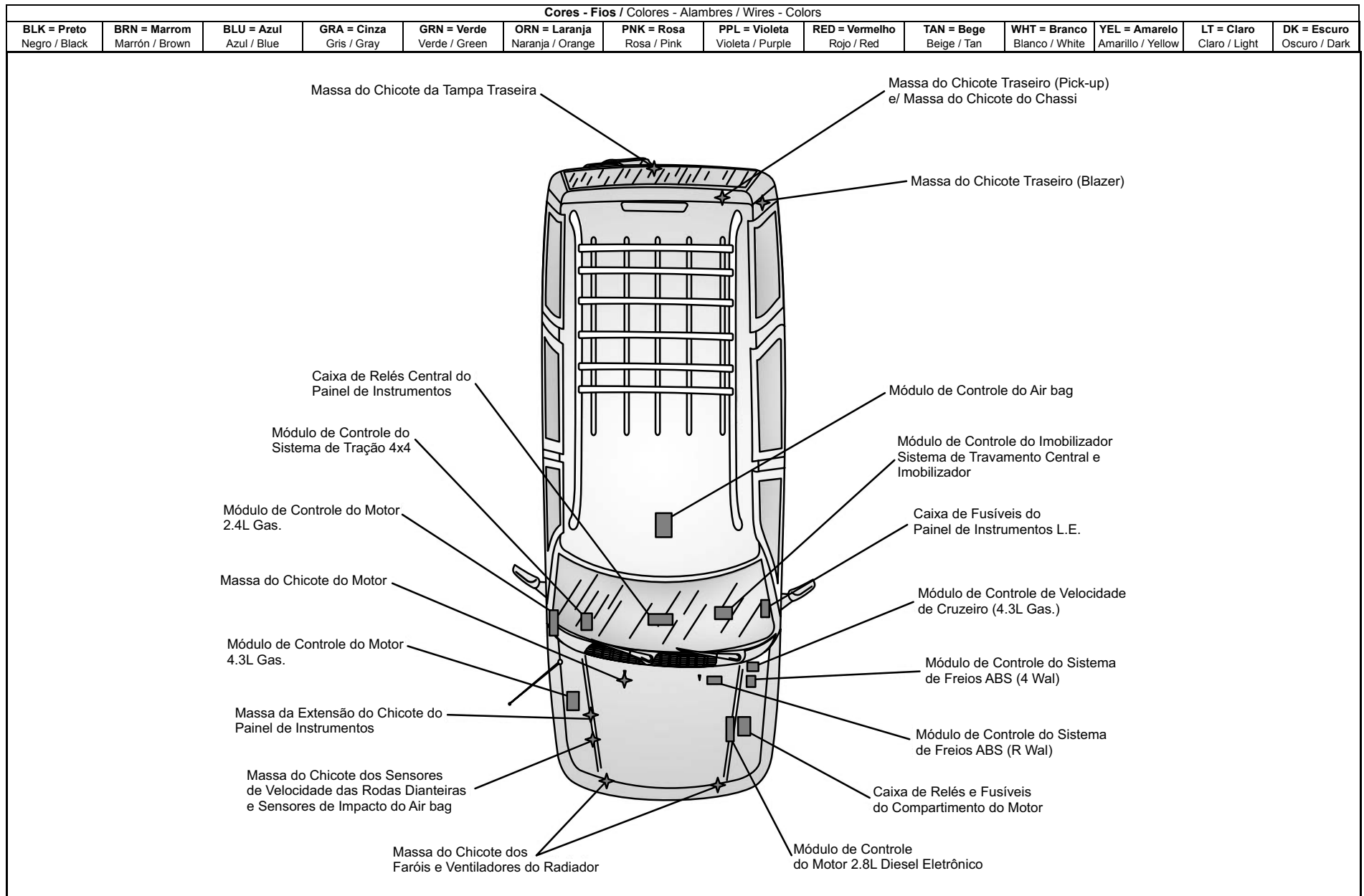

Cores - Fios / Cores - Alambres / Wires - Colors

BLK = Preto Negro / Black	BRN = Marrom Marrón / Brown	BLU = Azul Azul / Blue	GRA = Cinza Gris / Gray	GRN = Verde Verde / Green	ORN = Laranja Naranja / Orange	PNK = Rosa Rosa / Pink	PPL = Violeta Violeta / Purple	RED = Vermelho Rojo / Red	TAN = Bege Beige / Tan	WHT = Branco Blanco / White	YEL = Amarelo Amarillo / Yellow	LT = Claro Claro / Light	DK = Escuro Oscuro / Dark
-------------------------------------	---------------------------------------	----------------------------------	-----------------------------------	-------------------------------------	--	----------------------------------	--	-------------------------------------	----------------------------------	---------------------------------------	---	------------------------------------	-------------------------------------

FUSÍVEL	TIPO	CAPAC.	POSIÇÃO	DESCRIÇÃO
MF01	MAXIFUSÍVEL	30A	U/H	FUSÍVEL DO VENTILADOR DE ARREFECIMENTO-BAIXA VELOCIDADE
MF02	MAXIFUSÍVEL	30A	U/H	FUSÍVEL DO VENTILADOR DE ARREFECIMENTO-ALTA VELOCIDADE
MF03	MAXIFUSÍVEL	60A	U/H	FUSÍVEL DO CIRCUITO PRINCIPAL 30a
MF04	MAXIFUSÍVEL	60A	U/H	FUSÍVEL DO RELÉ AUXILIAR DE PARTIDA
MF05	MAXIFUSÍVEL	30A/60A	U/H	FUSÍVEL DO CIRCUITO PRINCIPAL 30b / FUSÍVEL DAS VELAS AQUECEDORAS
MF06	MAXIFUSÍVEL	40A	U/H	FUSÍVEL DE VENTILAÇÃO INTERNA
MF07	MAXIFUSÍVEL	60A	U/H	FUSÍVEL DO MÓDULO DE FREIO ABAS NAS 4 RODAS 4WAL
MF08	MAXIFUSÍVEL	50A	U/H	FUSÍVEL DO CIRCUITO PRINCIPAL 30c
MF09	MAXIFUSÍVEL	50A	U/H	FUSÍVEL DO CIRCUITO PRINCIPAL 15b
MF10	MAXIFUSÍVEL	50A	U/H	FUSÍVEL DOS CIRCUITOS PRINCIPAIS 15 E 15a

FUSÍVEL	TIPO	CAPAC.	POSIÇÃO	DESCRIÇÃO
F1	MINIFUSÍVEL	10A	U/H	FUSÍVEL: ECM (MPFI 2.4L) / RELÉ PRINCIPAL / SENSOR PRESSÃO DE ÓLEO
F2	MINIFUSÍVEL	10A	U/H	FUSÍVEL: RELÉ DE ARREFECIMENTO / INTERRUPTOR DO SOLENÓIDE (DIESEL 2.8L)
F3	MINIFUSÍVEL	10A	U/H	FUSÍVEL: ECM (MPFI 2.4 L) / RELÉ DA BOMBA DE COMBUSTÍVEL
F4	MINIFUSÍVEL	10A	U/H	FUSÍVEL: PCM / CANISTER / AQUECEDOR
F5	MINIFUSÍVEL	20A	U/H	FUSÍVEL: PCM / BOBINA DE IGNIÇÃO / MAF / INJETORES
F6	MINIFUSÍVEL	15A	U/H	FUSÍVEL: PCM / BOMBA DE COMBUSTÍVEL / SENSOR DE ÓLEO
F7	MINIFUSÍVEL	10A	U/H	FUSÍVEL: RELÉ, PARTIDA
F8	MINIFUSÍVEL	-	U/H	FUSÍVEL: LIVRE
F9	MINIFUSÍVEL	-	U/H	FUSÍVEL: LIVRE
F10	MINIFUSÍVEL	-	U/H	FUSÍVEL: LIVRE
F11	MINIFUSÍVEL	25A	U/H	FUSÍVEL: RELÉ DO AR CONDICIONADO
F12	MINIFUSÍVEL	10A	U/H	FUSÍVEL: MÓDULO ABS RODAS TRASEIRAS (RWAL)
F13	MINIFUSÍVEL	20A	U/H	FUSÍVEL: MÓDULO ABS RODAS TRASEIRAS (RWAL)
F14	MINIFUSÍVEL	25A	U/H	FUSÍVEL: COMPRESSOR DO AR CONDICIONADO (4.3L V6)
F15	MINIFUSÍVEL	15A	U/H	FUSÍVEL: BUZINA
F16	MINIFUSÍVEL	20A	U/H	FUSÍVEL: FAROL BAIXO
F17	MINIFUSÍVEL	20A	U/H	FUSÍVEL: FAROL ALTO
F18	MINIFUSÍVEL	10A	U/H	FUSÍVEL: MÓDULO DE CONTROLE AUTOMÁTICO

FUSÍVEL	POSIÇÃO	DESCRIÇÃO
K6	U/H	RELÉ DOS FARÓIS BAIXOS ALL
K8	U/H	RELÉ DOS FARÓIS ALTOS &LG1 / &LG3
K13	U/H	RELÉ DE ALTA VELOCIDADE DO VENTILADOR DE ARREFECIMENTO &LG1 / &LLK
K14	U/H	RELÉ DE BAIXA VELOCIDADE DO VENTILADOR DE ARREFECIMENTO &LG1 / &LLK
K14.1	U/H	RELÉ SÉRIE-PARALELO DO VENTILADOR DE ARREFECIMENTO &LG1
K18	U/H	RELÉ PRINCIPAL DO SISTEMA DE INJEÇÃO MPFI &LG1
K24	U/H	RELÉ AUXILIAR DE PARTIDA &LG1 / &LG3
K36	U/H	RELÉ DO COMPRESSOR DE A/C &C60 / &LLK
K43	U/H	RELÉ DE VENTILAÇÃO INTERNA &LG1 / &LG3
K72	U/H	RELÉ DE FALHA DO SISTEMA ABS &JA4 / &JM4 / &LLK
K80	U/H	RELÉ PRINCIPAL &LLK

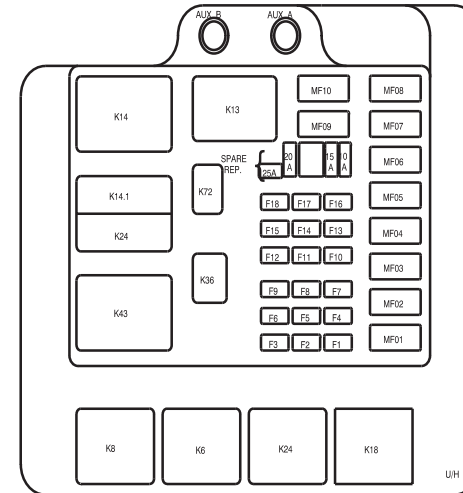

MOTOR 2.4L GASOLINA

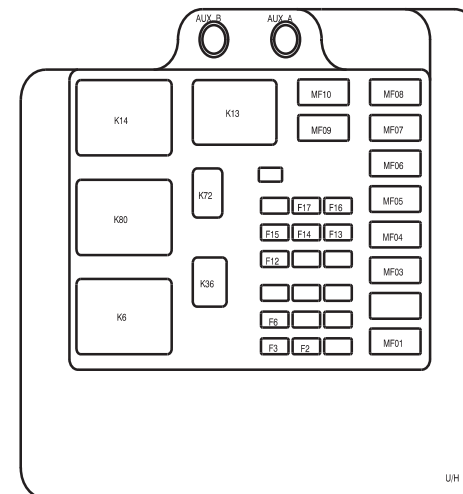

MOTOR 2.8L DIESEL



Cores - Fios / Colores - Alambres / Wires - Colors

BLK = Preto Negro / Black	BRN = Marrom Marrón / Brown	BLU = Azul Azul / Blue	GRA = Cinza Gris / Gray	GRN = Verde Verde / Green	ORN = Laranja Naranja / Orange	PNK = Rosa Rosa / Pink	PPL = Violeta Violeta / Purple	RED = Vermelho Rojo / Red	TAN = Bege Beige / Tan	WHT = Branco Blanco / White	YEL = Amarelo Amarillo / Yellow	LT = Claro Claro / Light	DK = Escuro Oscuro / Dark
-------------------------------------	---------------------------------------	----------------------------------	-----------------------------------	-------------------------------------	--	----------------------------------	--	-------------------------------------	----------------------------------	---------------------------------------	---	------------------------------------	-------------------------------------

RELÉ	DESCRIÇÃO	USO
K2	RELÉ DO ALARME - INDICADOR DIREÇÃO LD	& UA6
K3	RELÉ DO ALARME - INDICADOR DIREÇÃO LE	& UA6
K12	RELÉ DE ACIONAMENTO DA BUZINA	TODOS
K16	RELÉ DA BOMBA DE COMBUSTÍVEL	&LG1 / &LG3 / &LLK
K31	RELÉ DOS INDICADORES DE DIREÇÃO (BLINKER)	TODOS
K37	RELÉ MOTOR LIGADO	&LG3
K40	RELÉ LIMPADOR E LAVADOR DO VIDRO TRASEIRO	ST11506
K70	RELÉ MÓDULO DAS TRAVAS DAS PORTAS	&X32 / &ZZ6 - UA6
K73	RELÉ DOS FARÓIS AUXILIARES DE NEBLINA	&X32 / &ZZ6 / &UOM
H9	MÓDULO INTERNO DE ALARME (CHIME)	TODOS

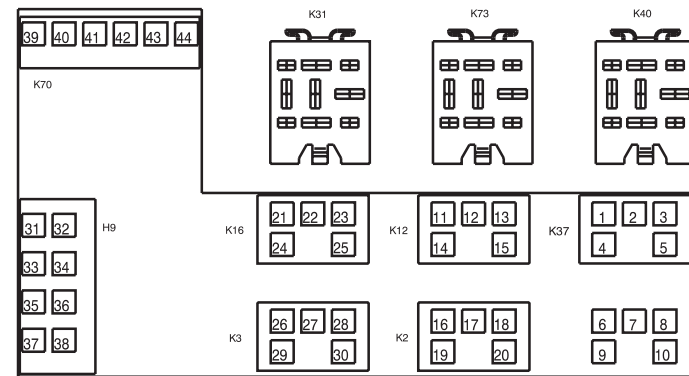

VISTA FRONTAL



Cores - Fios / Cores - Alambres / Wires - Colors														
BLK = Preto Negro / Black	BRN = Marrrom Marrón / Brown	BLU = Azul Azul / Blue	GRA = Cinza Gris / Gray	GRN = Verde Verde / Green	ORN = Laranja Naranja / Orange	PNK = Rosa Rosa / Pink	PPL = Violeta Violeta / Purple	RED = Vermelho Rojo / Red	TAN = Bege Beige / Tan	WHT = Branco Blanco / White	YEL = Amarelo Amarillo / Yellow	LT = Claro Claro / Light	DK = Escuro Oscuro / Dark	
FUSÍVEL	TIPO	POSIÇÃO	DESCRIÇÃO											
F1	MINIFUSÍVEL	20A	I/P	FUSÍVEL: ACENDEDOR DE CIGARROS (E TOMADA DE FORÇA 12V)										
F2	MINIFUSÍVEL	10A	I/P	FUSÍVEL: MÓDULO ALARME ANTIFURTO										
F3	MINIFUSÍVEL	20A	I/P	FUSÍVEL: ILUMINAÇÃO: LANTERNAS TRAS. / PLACA DE LICENÇA / ACENDEDOR DE CIGARROS / SISTEMA DE SOM / INTERIOR CAPUZ / LUZ DO TETO / INTERRUPTOR DE ILUMINAÇÃO / LUZES DE ESTACIONAMENTO										
F4	MINIFUSÍVEL	20A	I/P	FUSÍVEL: PAINEL DE INSTRUMENTOS / MÓDULO 4X4 / 4X4 – INTERRUPTOR DO EIXO DIANTEIRO										
F5	MINIFUSÍVEL	20A	I/P	FUSÍVEL: MÓDULO AIR BAG (DUPL0)										
F6	MINIFUSÍVEL	25A	I/P	FUSÍVEL: VENTILAÇÃO / AR CONDICIONADO										
F7	MINIFUSÍVEL	25A	I/P	FUSÍVEL: ALDL										
F8	MINIFUSÍVEL	30A	I/P	FUSÍVEL: DESEMBAÇADOR TRASEIRO										
F9	MINIFUSÍVEL	15A	I/P	FUSÍVEL: LUZES DE ALERTA / INTERRUPTOR DO FREIO / MÓDULO DE ALARME INTERNO										
F10	MINIFUSÍVEL	5A	I/P	FUSÍVEL: MÓDULO IMOBILIZADOR DE IGNIÇÃO & PARTIDA / MÓDULO DE ALARME										
F11	MINIFUSÍVEL	20A	I/P	FUSÍVEL: INTERRUPTOR NSBU (4.3L V6 AT)										
F12	MINIFUSÍVEL	15A	I/P	FUSÍVEL: DRAC / MÓDULO DE ALARME INTERNO / INTERRUPTOR DO FREIO (ABS)										
F13	MINIFUSÍVEL	10A	I/P	FUSÍVEL: SISTEMA DE SOM										
F14	MINIFUSÍVEL	10A	I/P	FUSÍVEL: REDUTOR DE TENSÃO										
F15	MINIFUSÍVEL	20A	I/P	FUSÍVEL: FAROL DE NEBLINA / LANTERNA TRASEIRA DE NEBLINA										
F16	MINIFUSÍVEL	15A	I/P	FUSÍVEL: INDICADOR DE DIREÇÃO / LUZES DE RÉ / NSBU INTERRUPTOR (4.3L V6 AT)										
F17	MINIFUSÍVEL	25A	I/P	FUSÍVEL: LIMPADOR E LAVADOR DIANTEIRO										
F18	MINIFUSÍVEL	10A	I/P	FUSÍVEL: COMANDO DE FARÓIS										
F19	MINIFUSÍVEL	20A	I/P	FUSÍVEL: MÓDULO 4X4										
F20	MINIFUSÍVEL	-	I/P	LIVRE										
F21	MINIFUSÍVEL	10A	I/P	FUSÍVEL: LUZ DE CORTESIA / ILUM. CONSOLE DO TETO / LUZ DE LEITURA / PAINEL DE INSTRUMENTOS										
F22	MINIFUSÍVEL	25A	I/P	FUSÍVEL: LIMPADOR E LAVADOR TRASEIRO										
F23	MINIFUSÍVEL	10A	I/P	FUSÍVEL: ESPELHO ELÉTRICO / ILUM. CONSOLE DO TETO / INTERRUPTOR DO LIMPADOR E LAVADOR TRASEIRO / DESEMBAÇADOR TRASEIRO / RÁDIO										
F24	MINIFUSÍVEL	-	I/P	LIVRE										
DA	DISJUNTOR		I/P	DISJUNTOR: TRAVA ELÉTRICA DAS PORTAS										
DB	DISJUNTOR		I/P	DISJUNTOR: LEVANTADOR DO VIDRO ELÉTRICO										

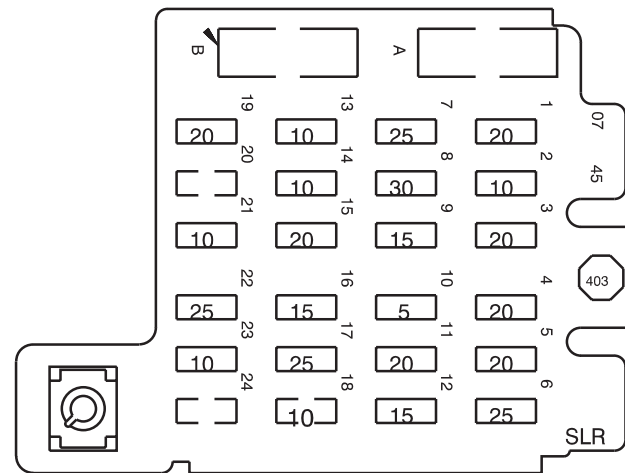

VISTA FRONTAL



Cores - Fios / Cores - Alambres / Wires - Colors

BLK = Preto Negro / Black	BRN = Marrom Marrón / Brown	BLU = Azul Azul / Blue	GRA = Cinza Gris / Gray	GRN = Verde Verde / Green	ORN = Laranja Naranja / Orange	PNK = Rosa Rosa / Pink	PPL = Violeta Violeta / Purple	RED = Vermelho Rojo / Red	TAN = Bege Beige / Tan	WHT = Branco Blanco / White	YEL = Amarelo Amarillo / Yellow	LT = Claro Claro / Light	DK = Escuro Oscuro / Dark
-------------------------------------	---------------------------------------	----------------------------------	-----------------------------------	-------------------------------------	--	----------------------------------	--	-------------------------------------	----------------------------------	---------------------------------------	---	------------------------------------	-------------------------------------

LG1

	CIRCUITO	DESCRIÇÃO
1		
2	1807	MÓDULO ABS 4WAL PINO B6
3	1601	MÓDULO IMOBILIZADOR PINO 8
4	150	MASSA
5	151	MASSA
6	448	MÓDULO ECM PINO 13
7	461	MÓDULO ECM PINO 55
8	483	PAINEL DE INSTRUMENTOS PINO 9 / MÓDULO DO ALARME PINO 21/28
9	800	MÓDULO AIR BAG PINO 05
10		
11		
12	696	MÓDULO ABS RWAL PINO D / MÓDULO DRAC PINO 10
13		
14		
15		
16	840	FUSÍVEL 7 (25A)

LG3

	CIRCUITO	DESCRIÇÃO
1		
2	1807/799	MÓDULO ABS PINO B6 / MÓDULO IMOBILIZADOR PINO 7 / PCM PINO 5J1-58 & J1-59
3	1601	MÓDULO IMOBILIZADOR PINO 8
4	150	MASSA
5	151	MASSA
6		
7		
8	483	PAINEL DE INSTRUMENTOS PINO 9 / MÓDULO ALARME PINO 21/28
9	800	MÓDULO AIRBAG PINO 5
10		
11		
12	696	MÓDULO ABS PINO D / MÓDULO ABS 4WAL PINO B1 / PCM PINO J2-49
13	1568	MÓDULO 4X4 PINO D3
14		
15		
16	840	FUSÍVEL 7 (25A)

LLK

	CIRCUITO	DESCRIÇÃO
1		
2	1807	MÓDULO ABS 4WAL PINO B6
3	1601	MÓDULO IMOBILIZADOR PINO 8
4	150	MASSA
5	151	MASSA
6		
7	448	MÓDULO ECM PINO 25
8	483	PAINEL DE INSTRUMENTOS PINO 9 / MÓDULO DO ALARME PINO 21/28
9	800	MÓDULO AIR BAG PINO 05
10		
11		
12	696	MÓDULO ABS RWAL PINO D / MÓDULO DRAC PINO 10
13	1568	MÓDULO 4X4 PINO D3
14		
15		
16	840	FUSÍVEL 7 (25A)



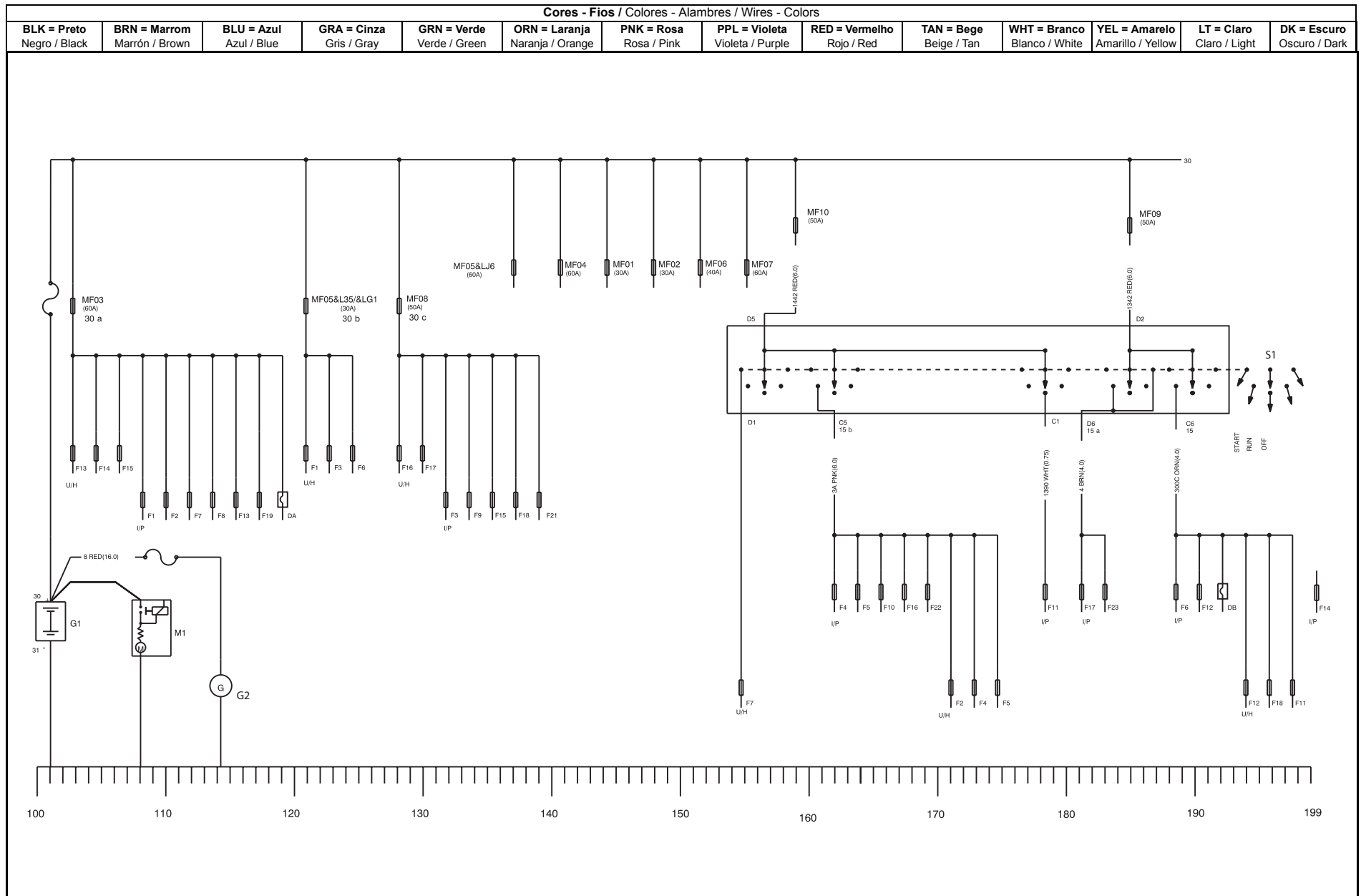

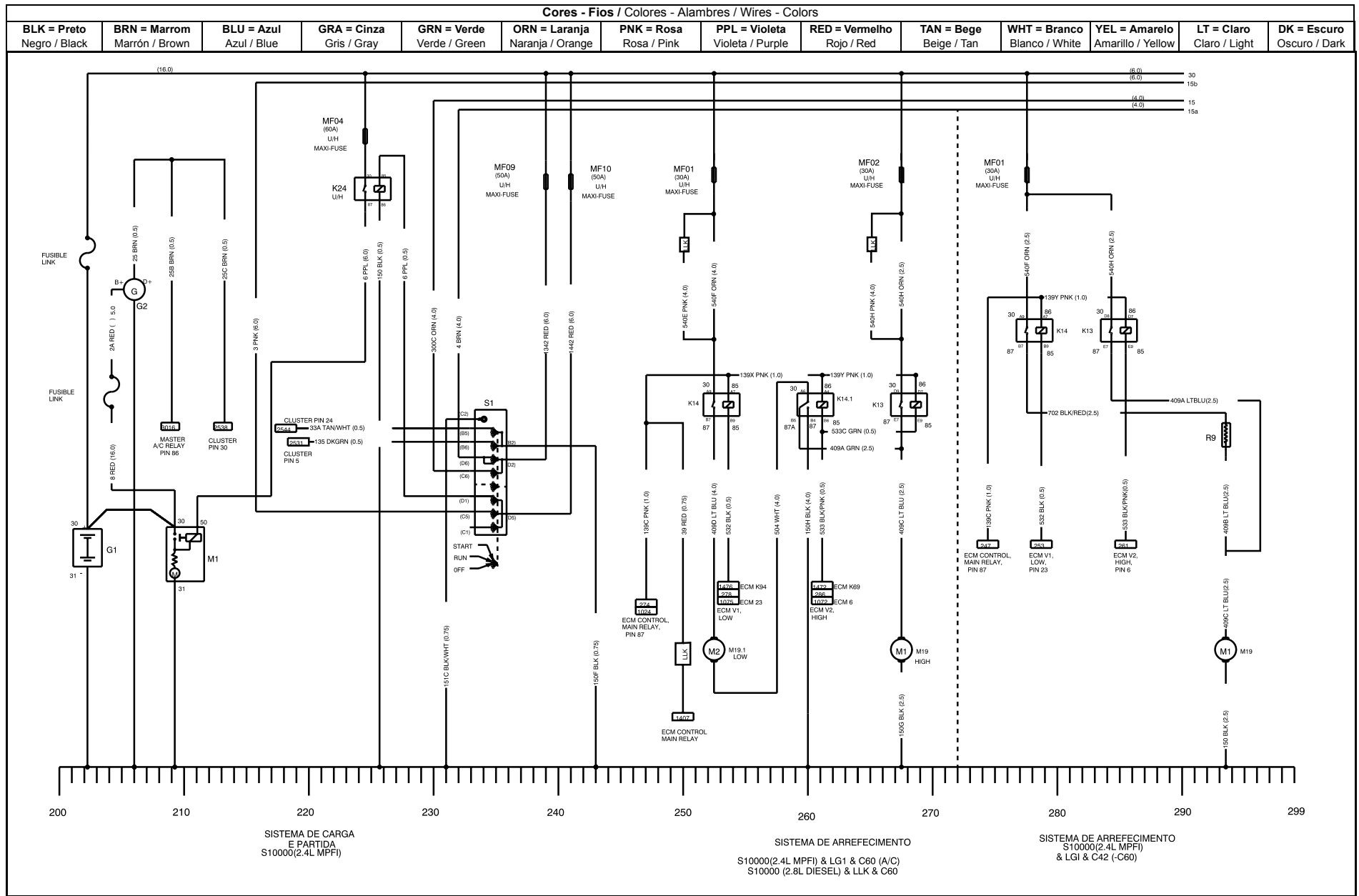

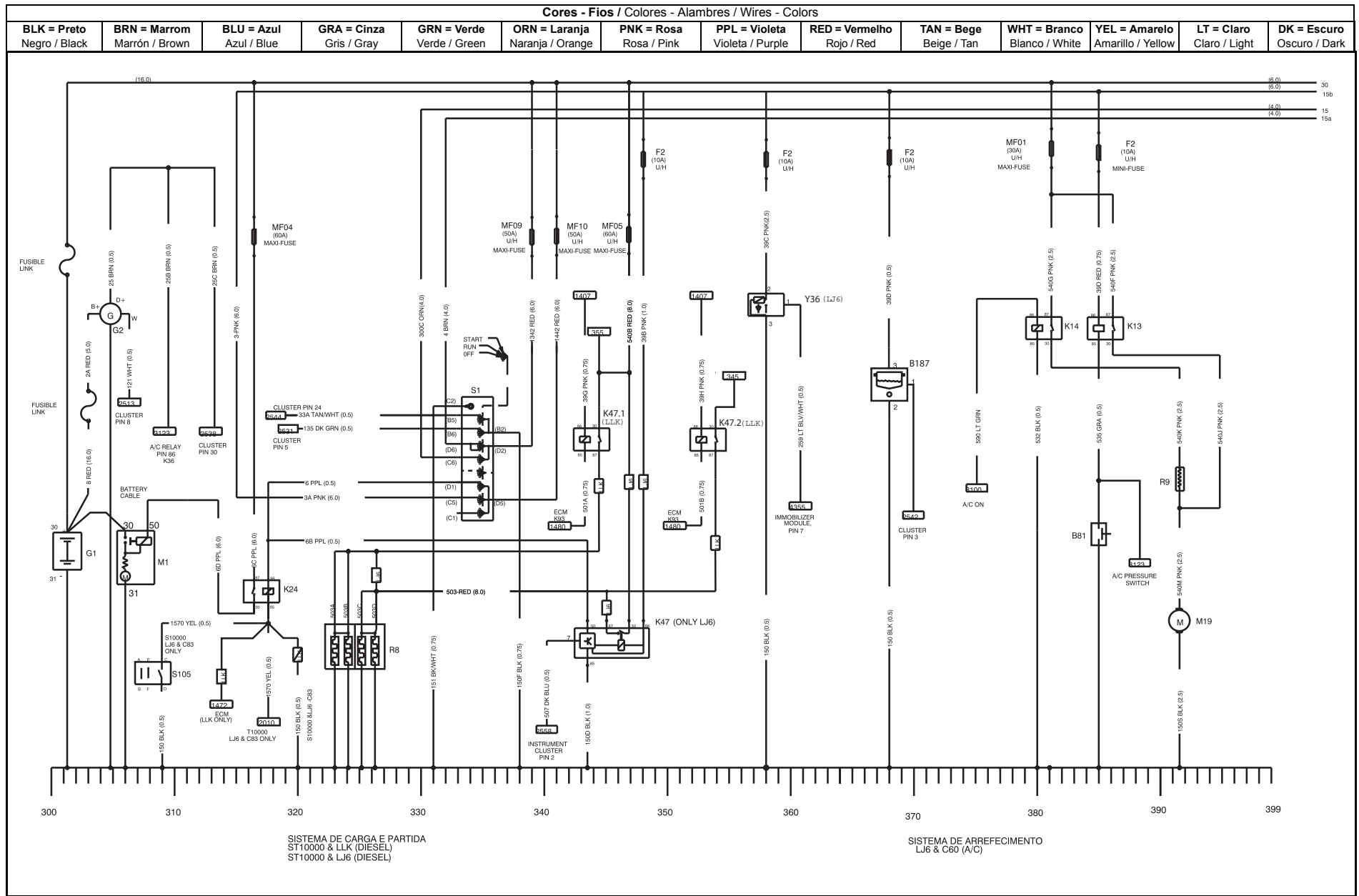

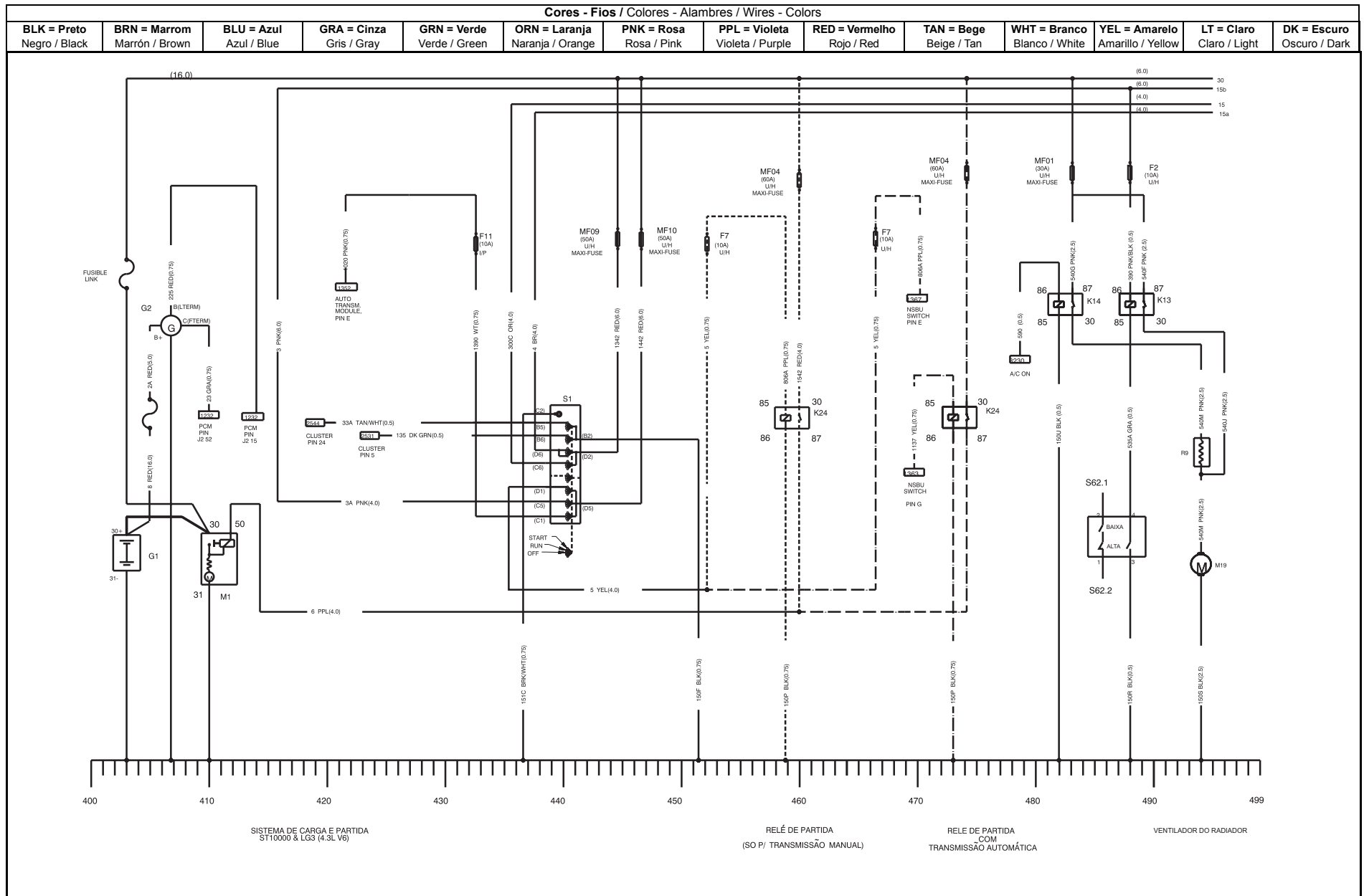

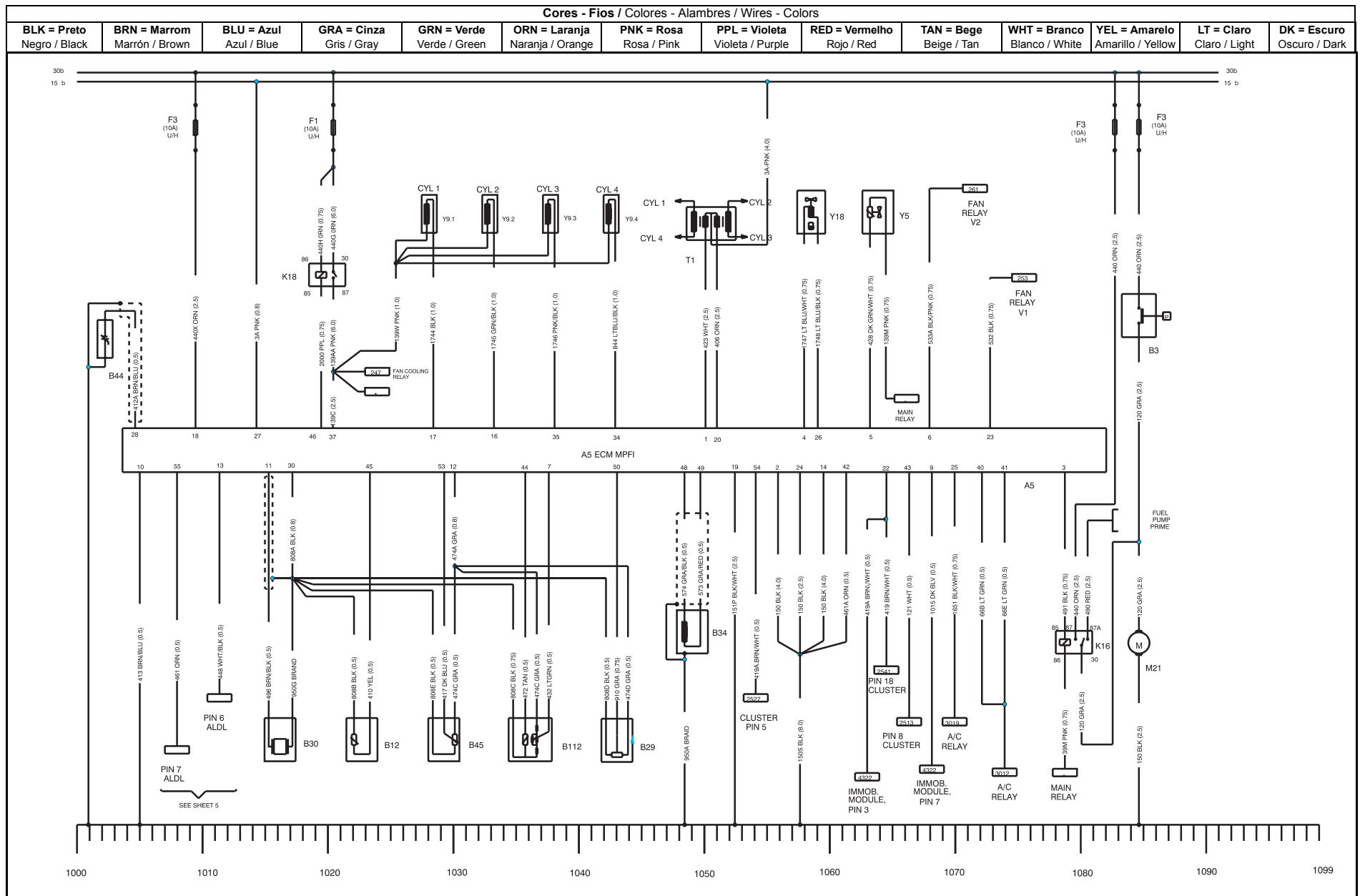

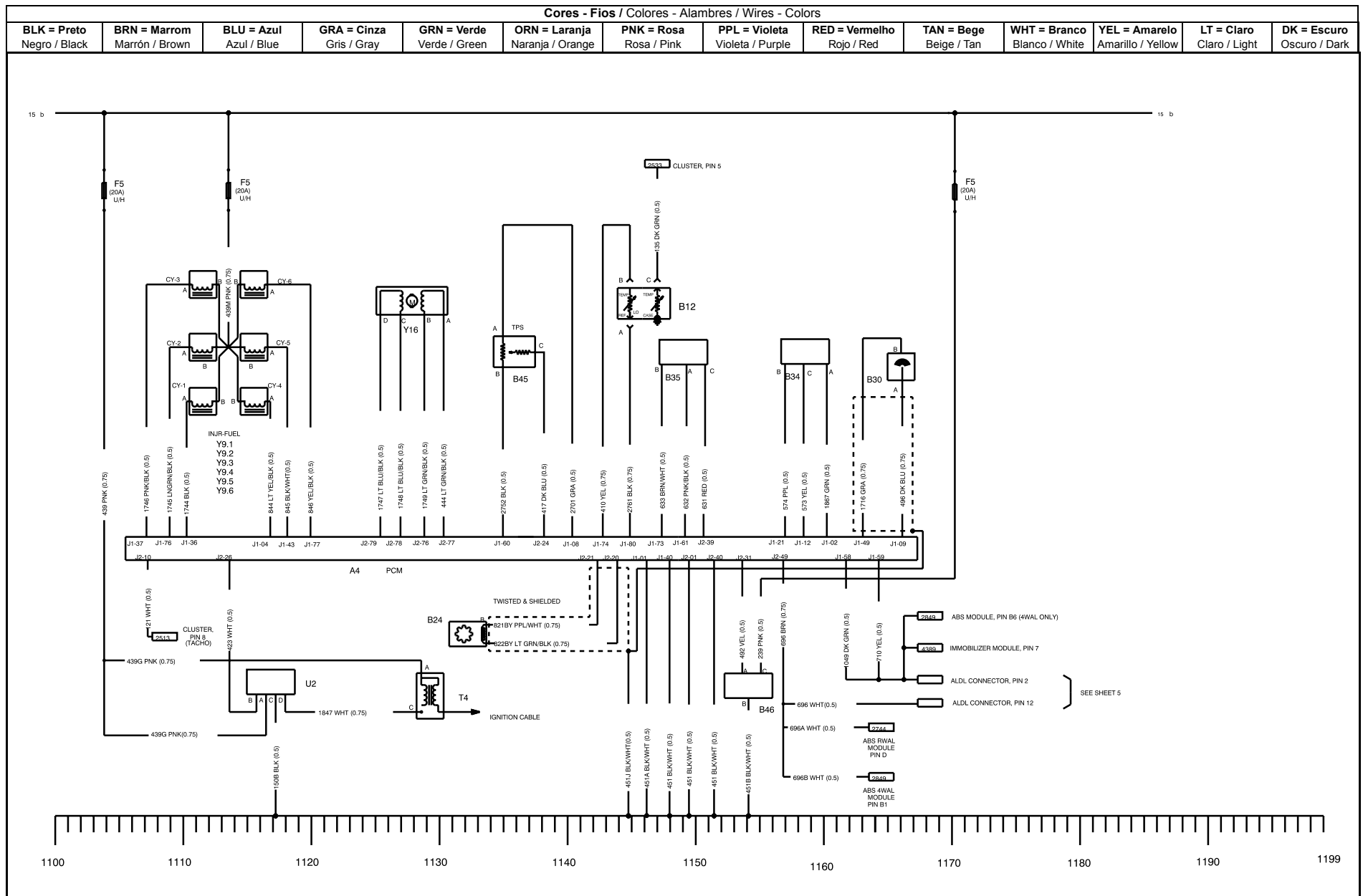

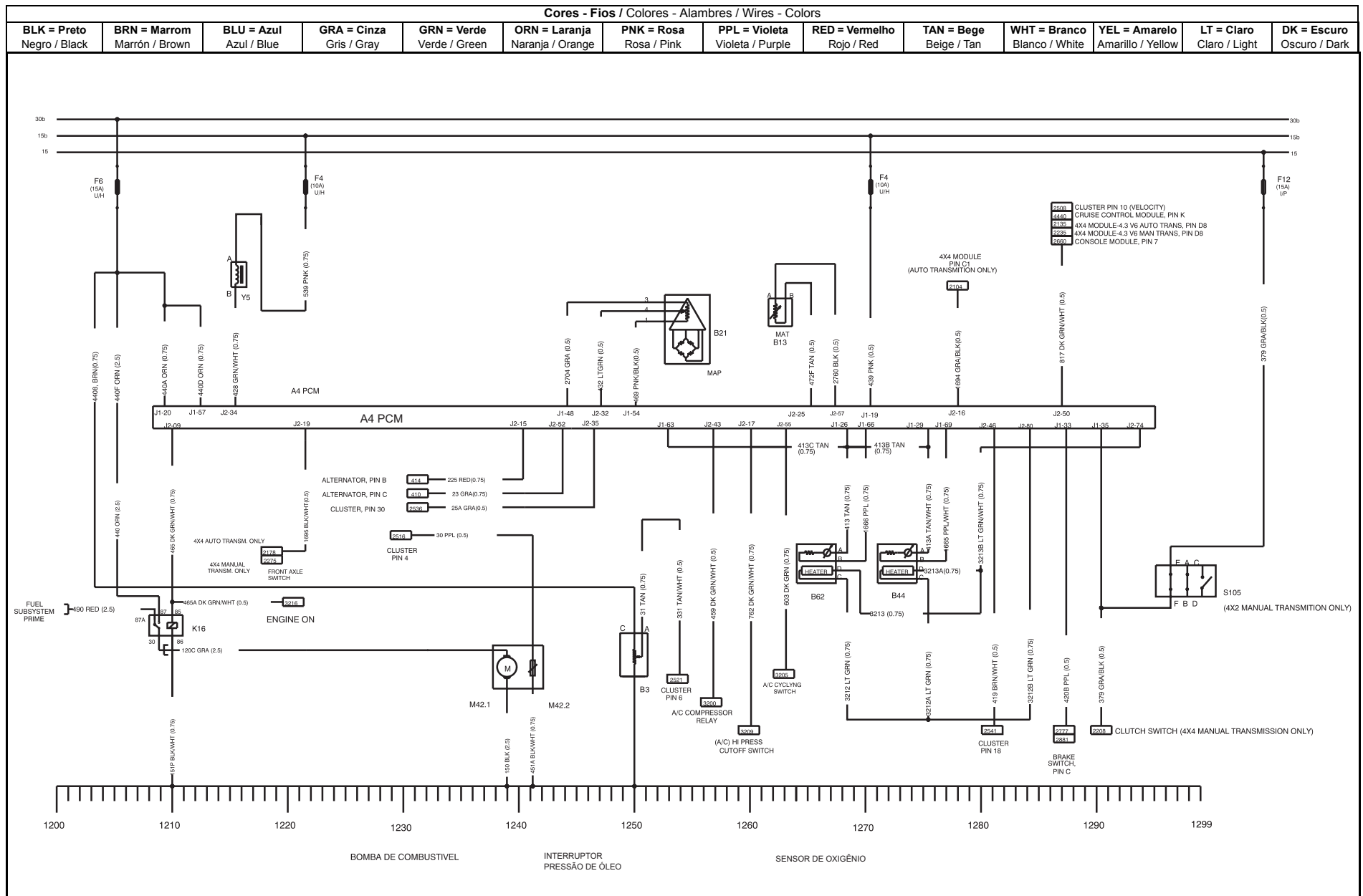

Cores - Fios / Colores - Alambres / Wires - Colors

BLK = Preto Negro / Black	BRN = Marrom Marrón / Brown	BLU = Azul Azul / Blue	GRA = Cinza Gris / Gray	GRN = Verde Verde / Green	ORN = Laranja Naranja / Orange	PNK = Rosa Rosa / Pink	PPL = Violeta Violeta / Purple	RED = Vermelho Rojo / Red	TAN = Bege Beige / Tan	WHT = Branco Blanco / White	YEL = Amarelo Amarillo / Yellow	LT = Claro Claro / Light	DK = Escuro Oscuro / Dark
------------------------------	--------------------------------	---------------------------	----------------------------	------------------------------	-----------------------------------	---------------------------	-----------------------------------	------------------------------	---------------------------	--------------------------------	------------------------------------	-----------------------------	------------------------------

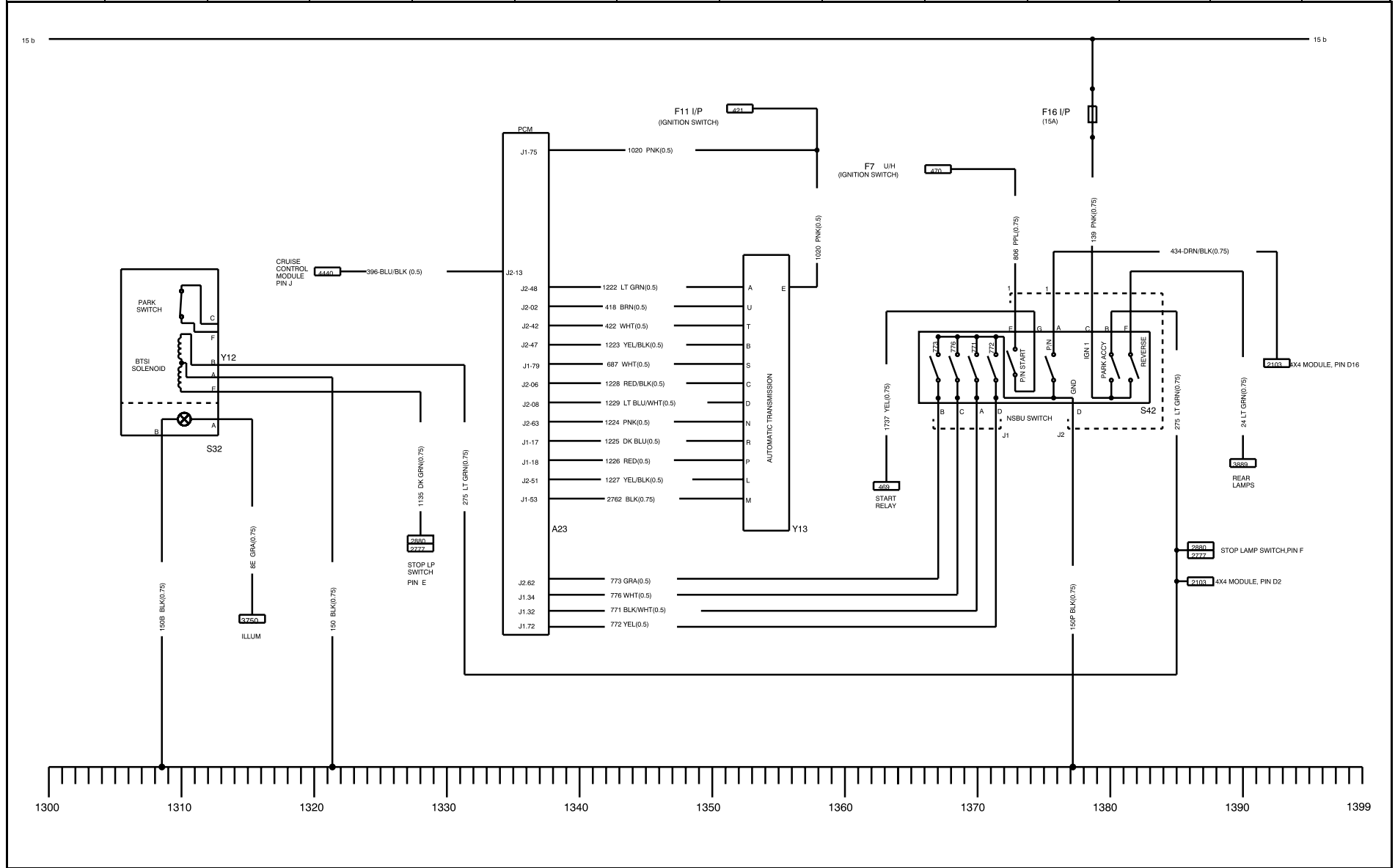

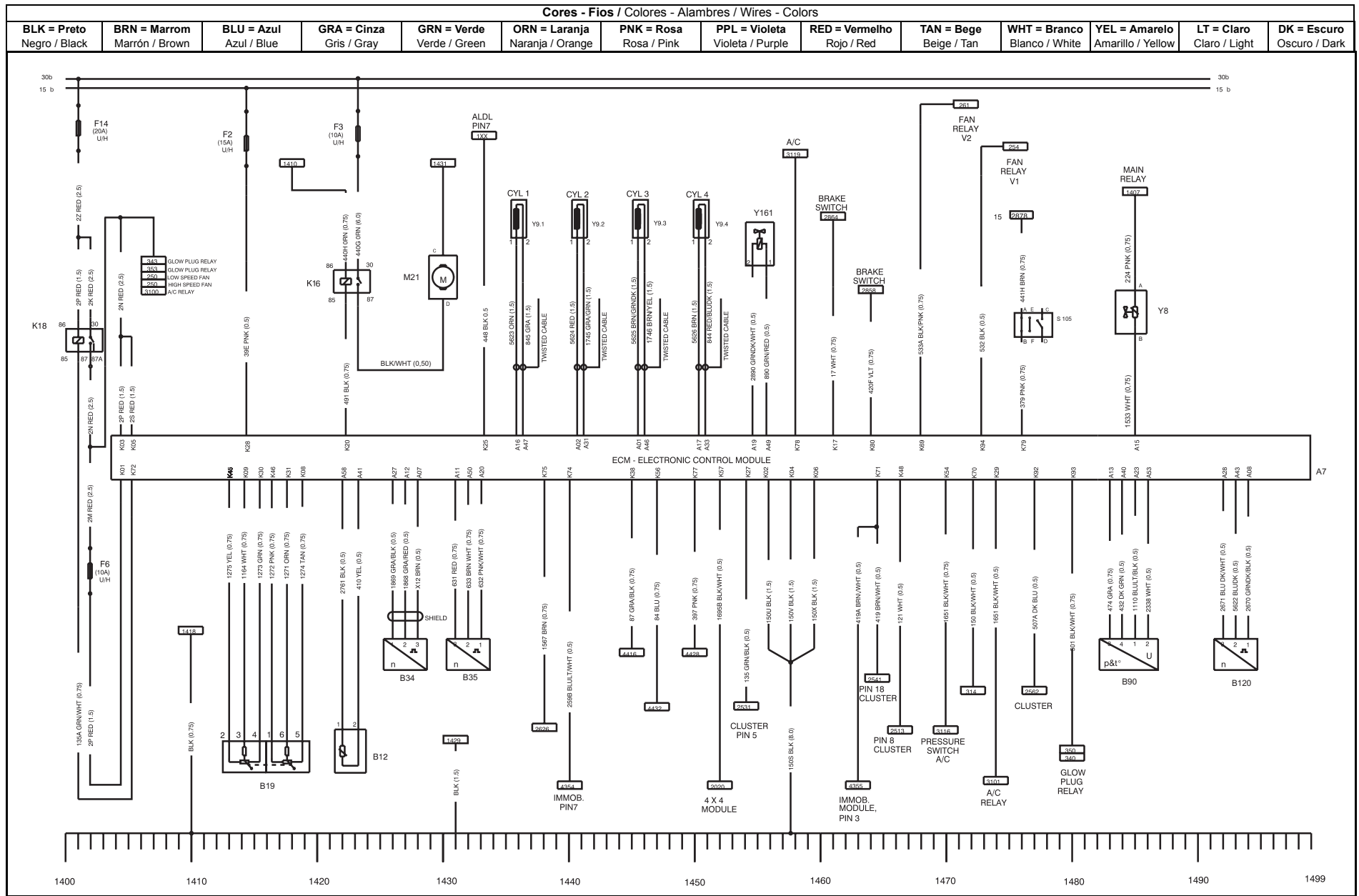

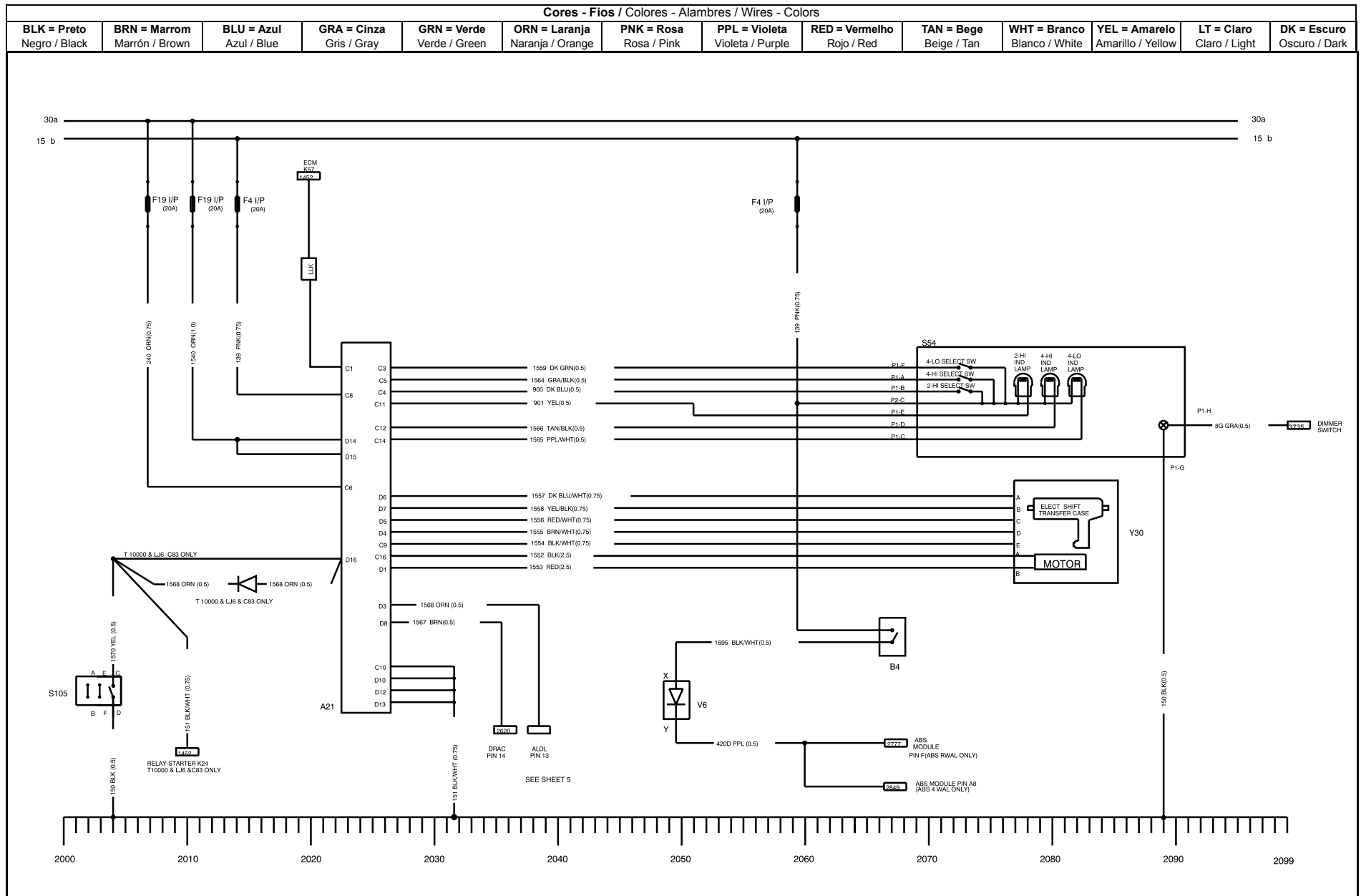

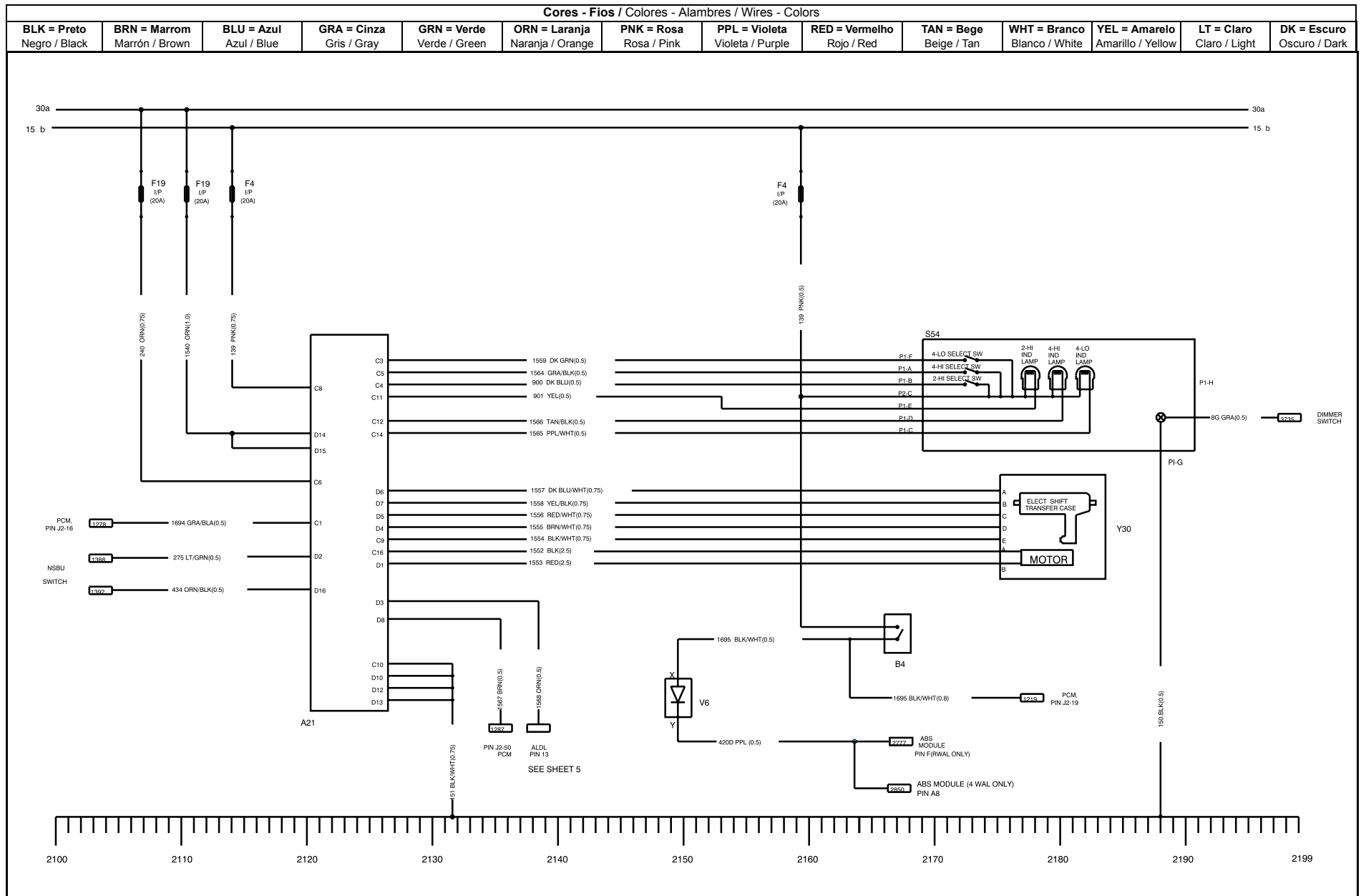

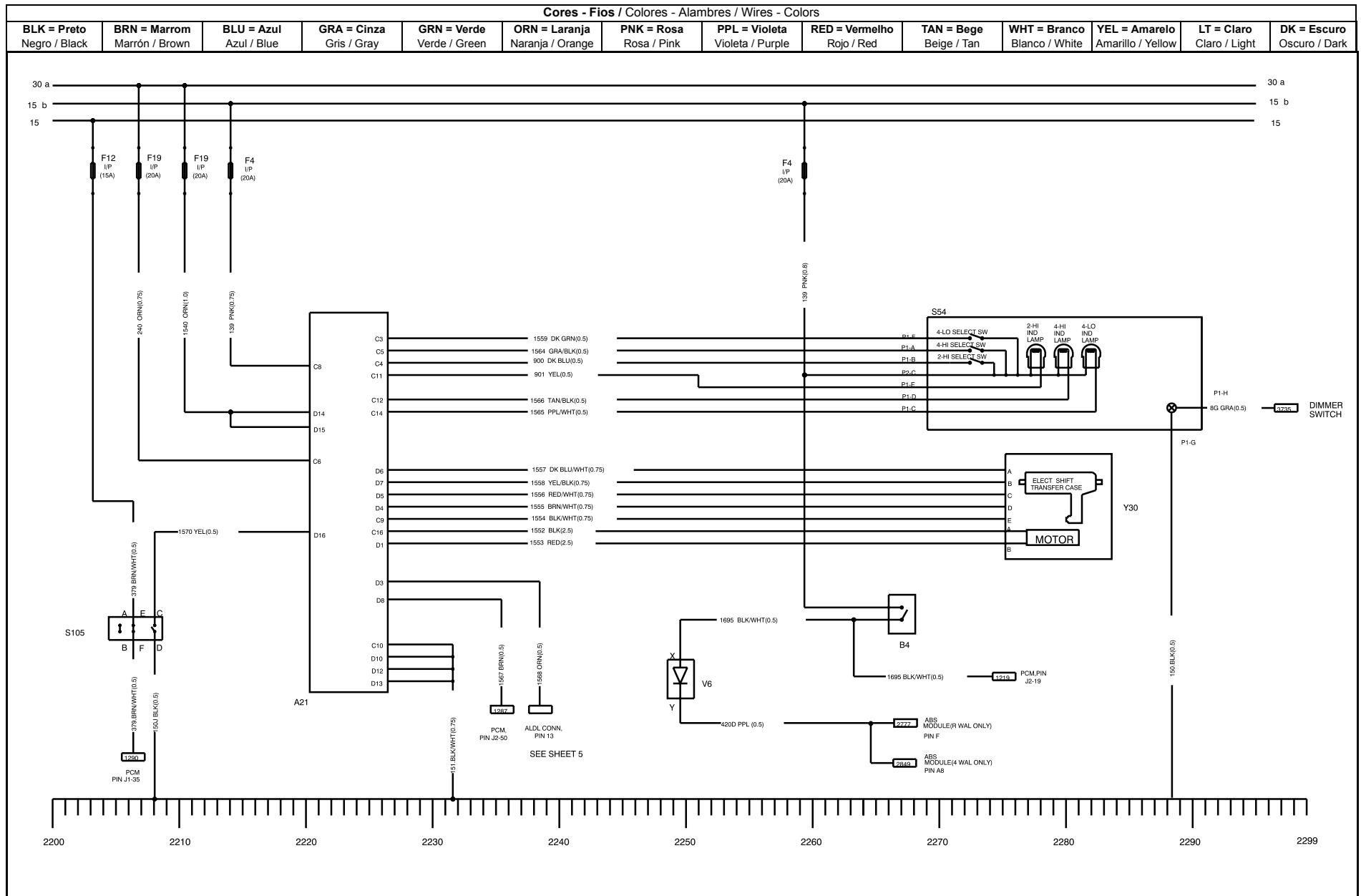

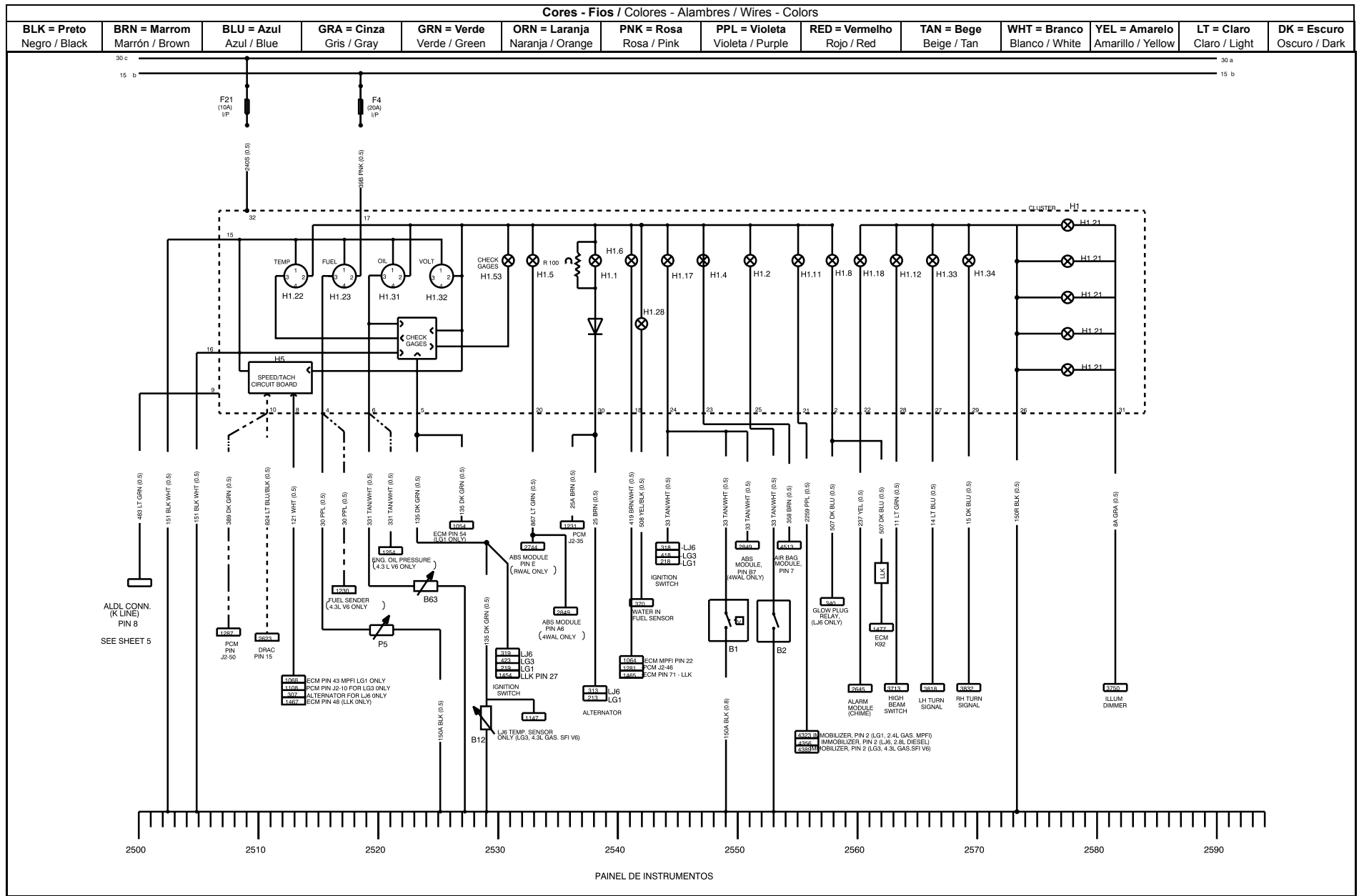

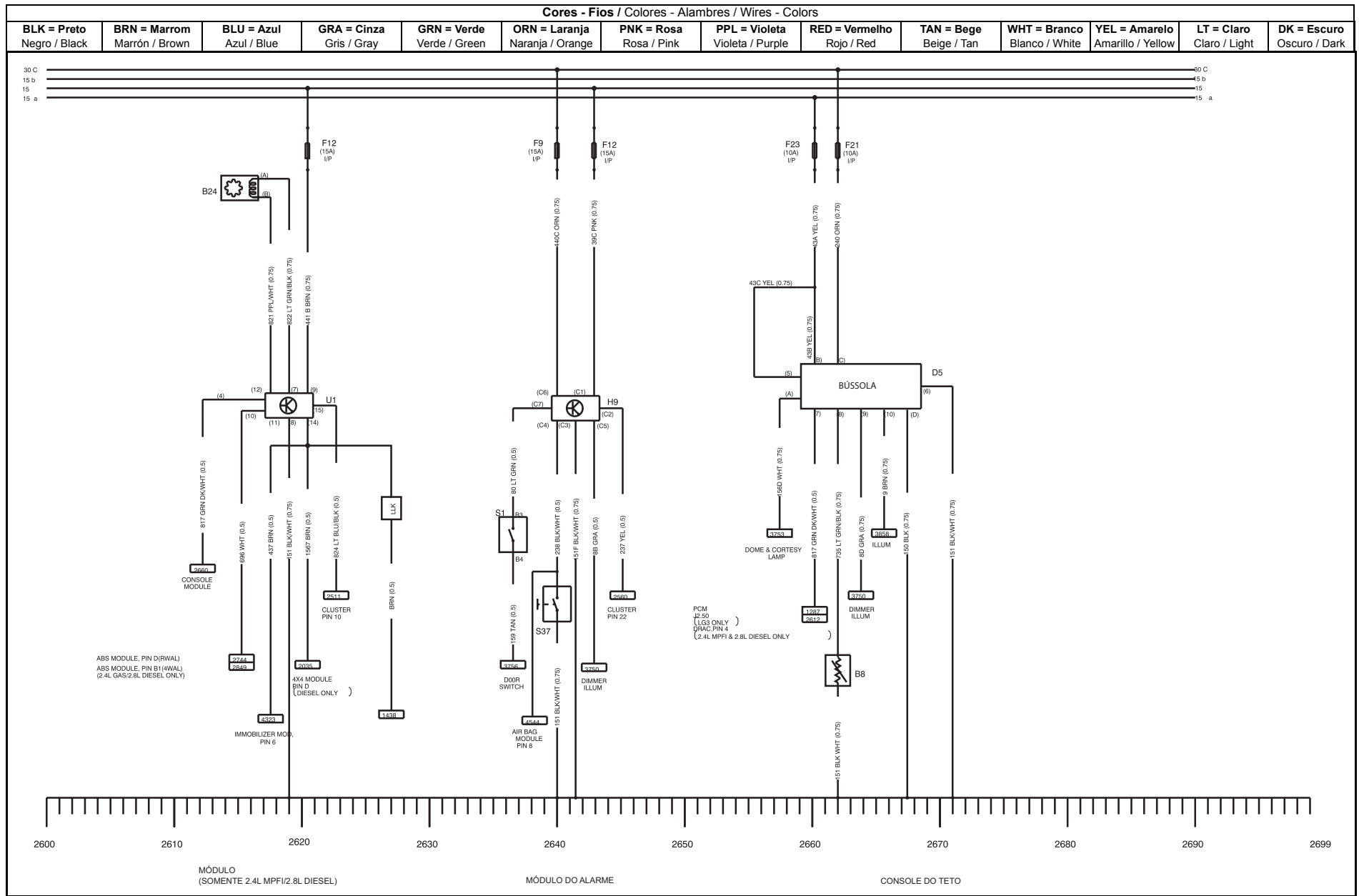

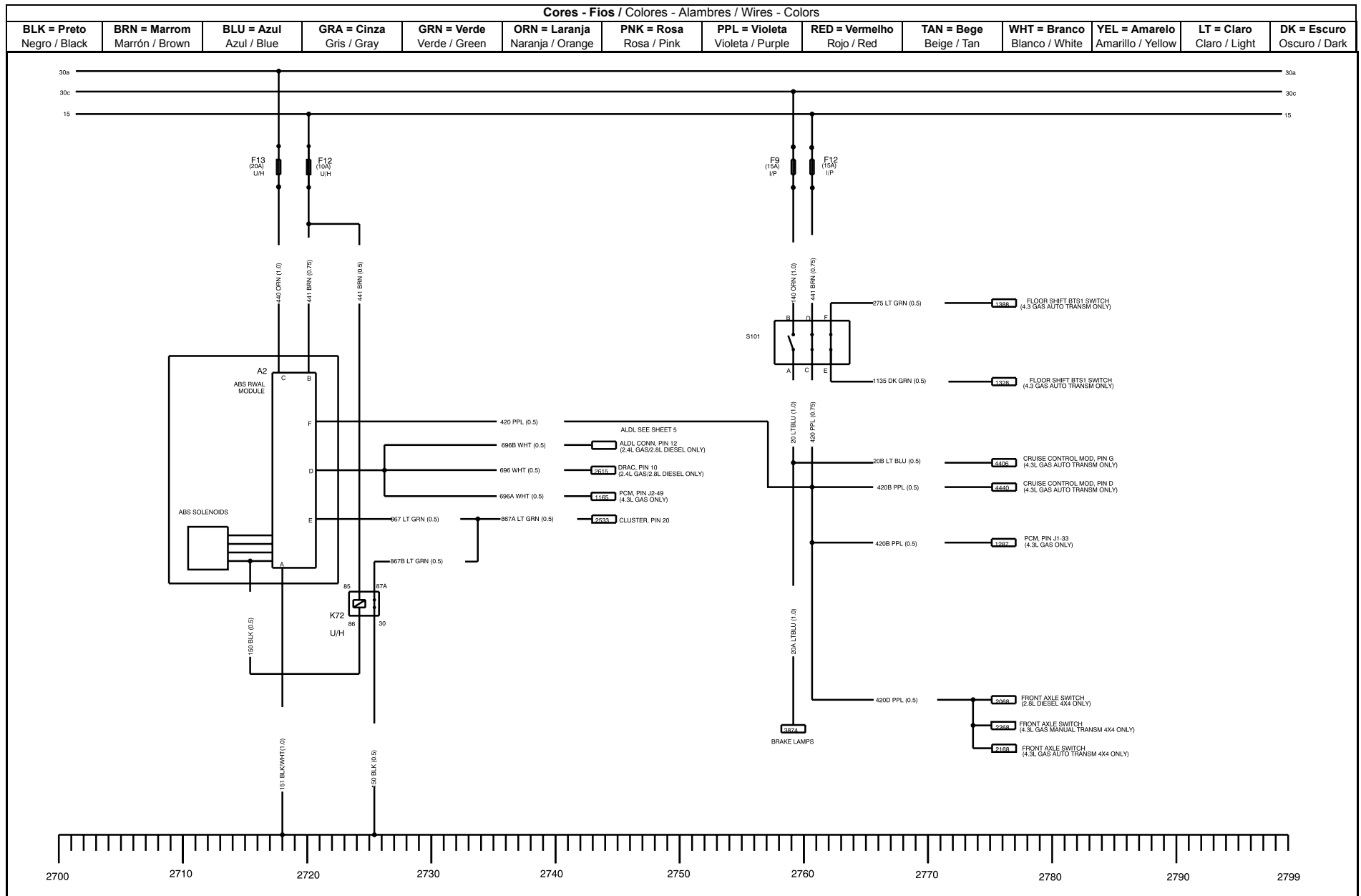

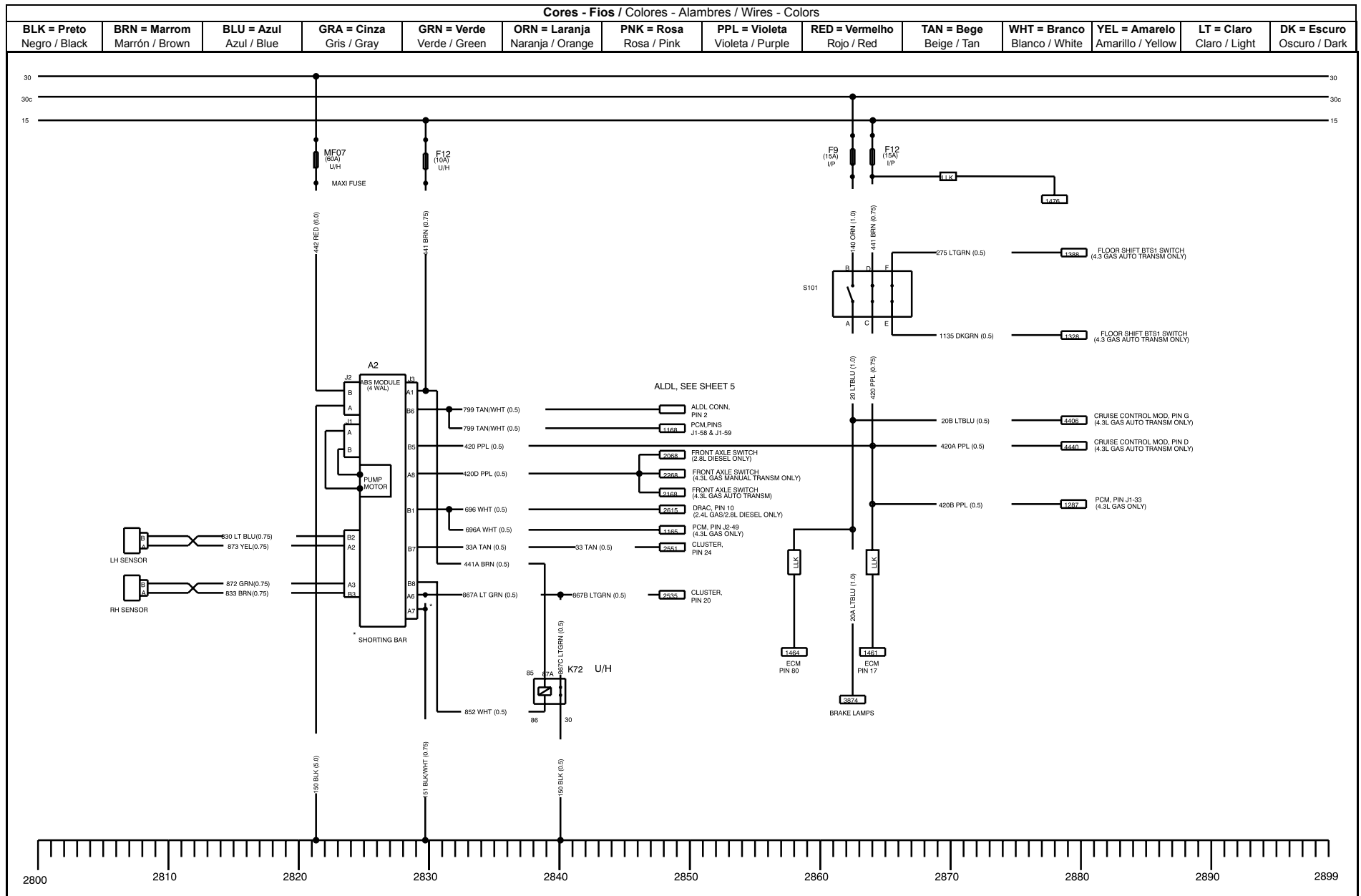

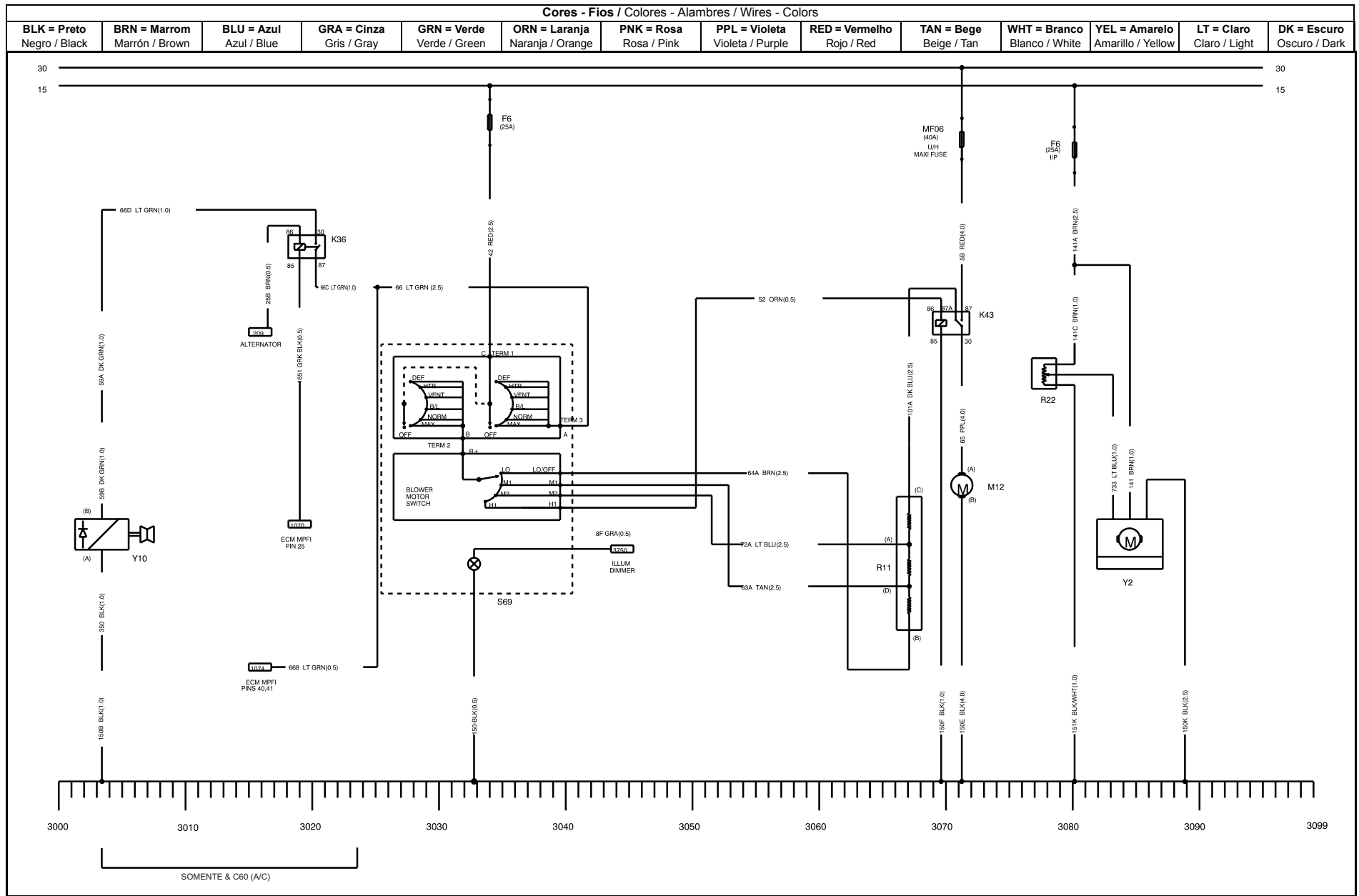

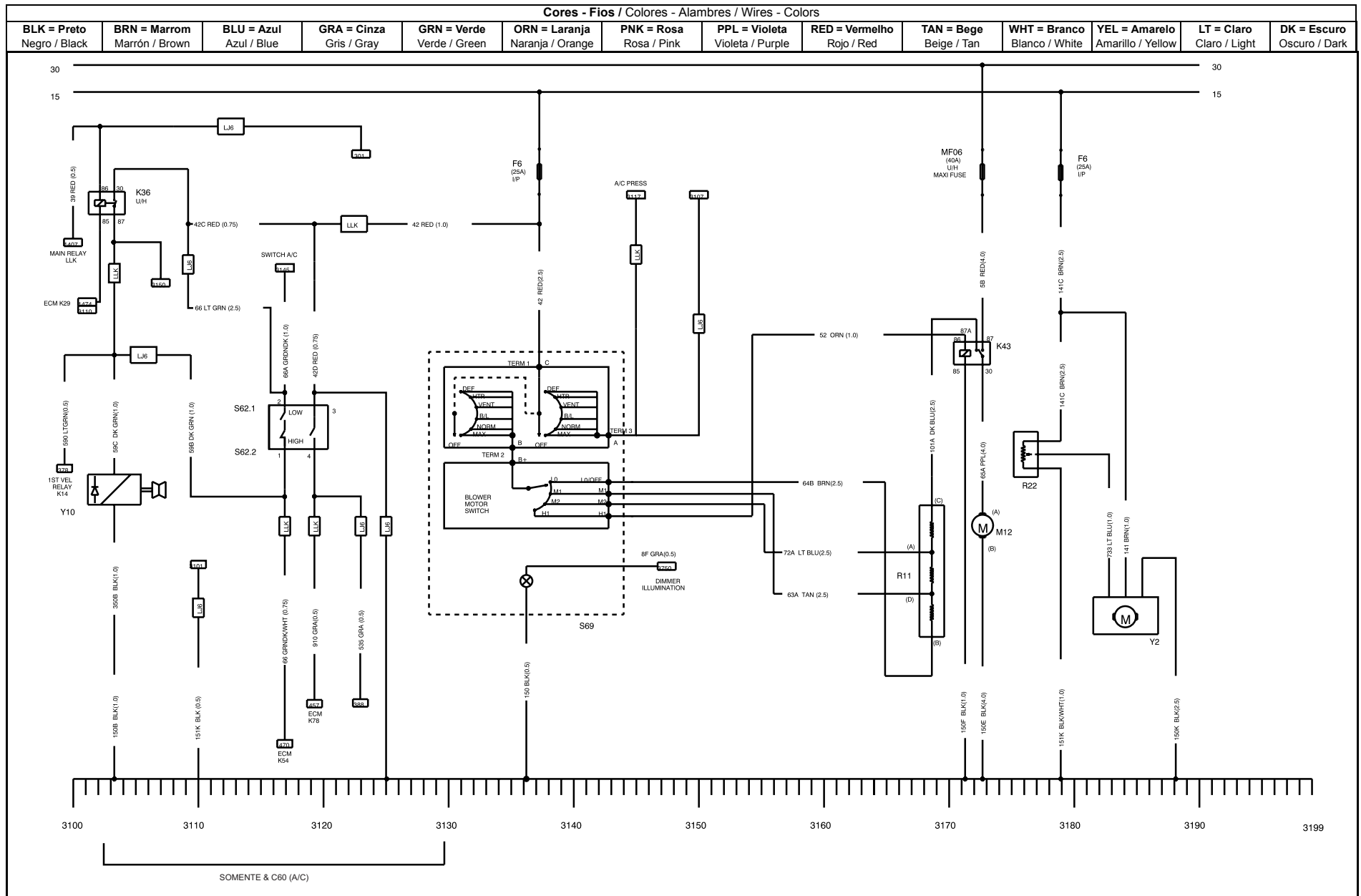

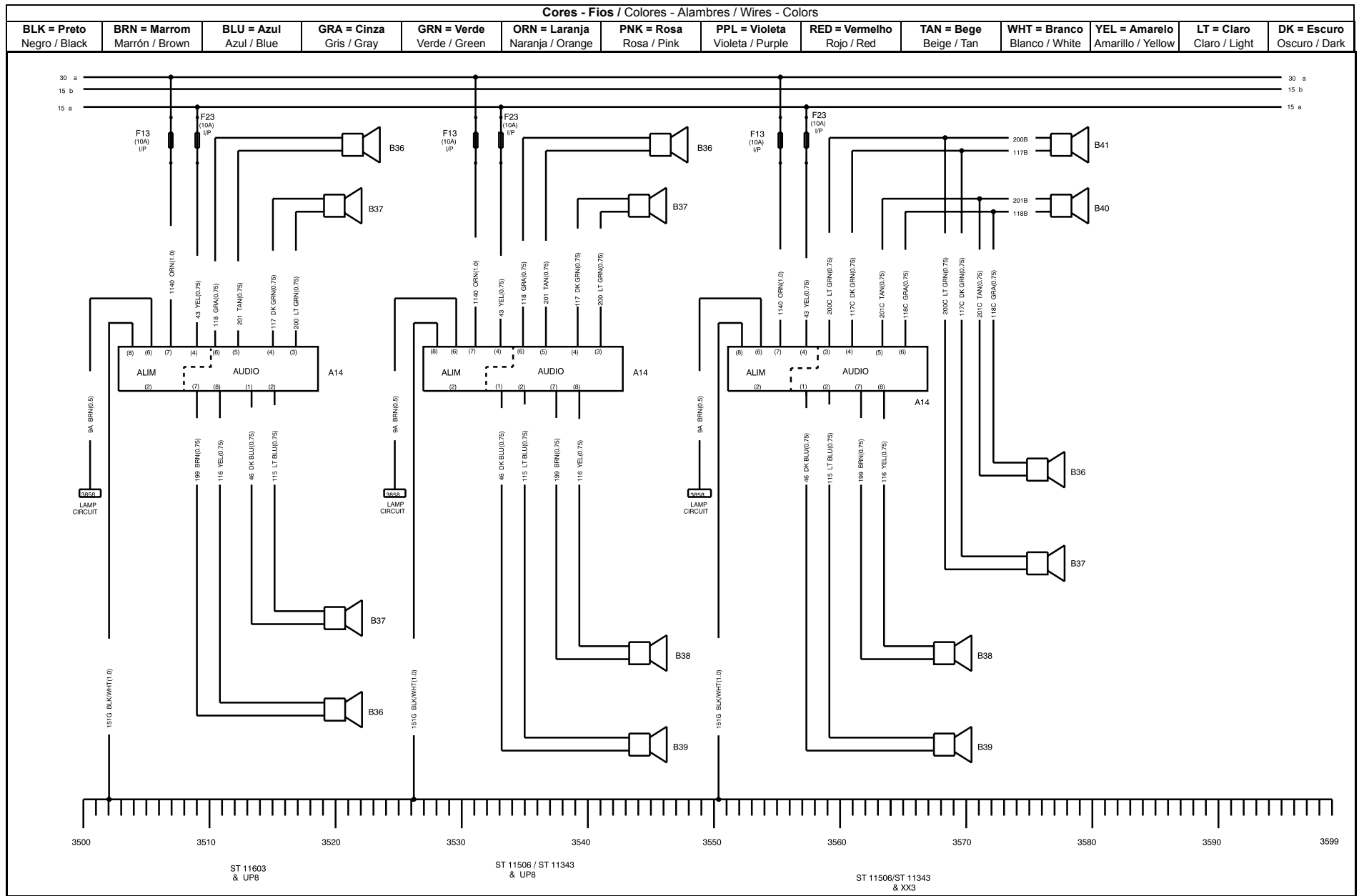

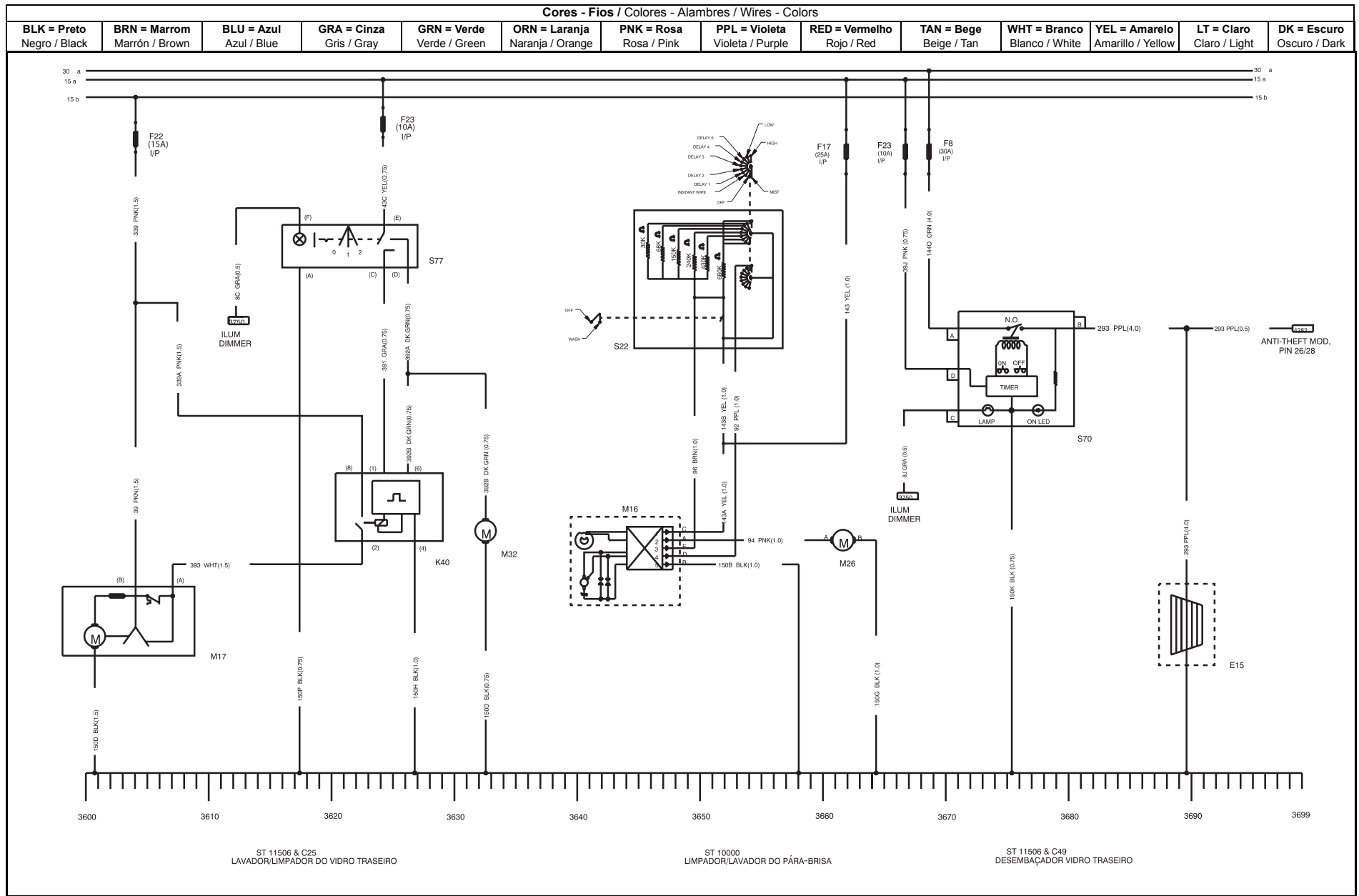

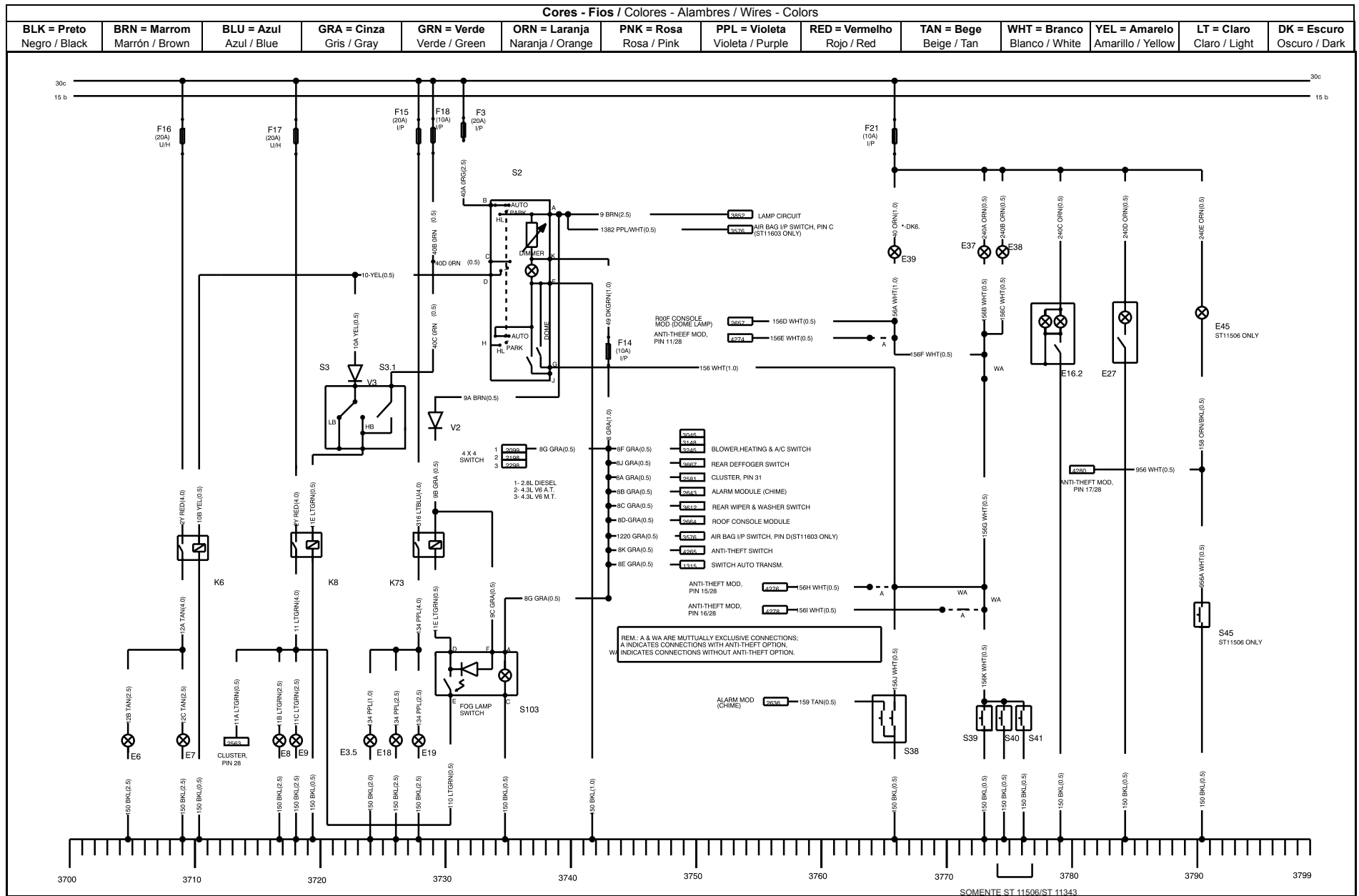

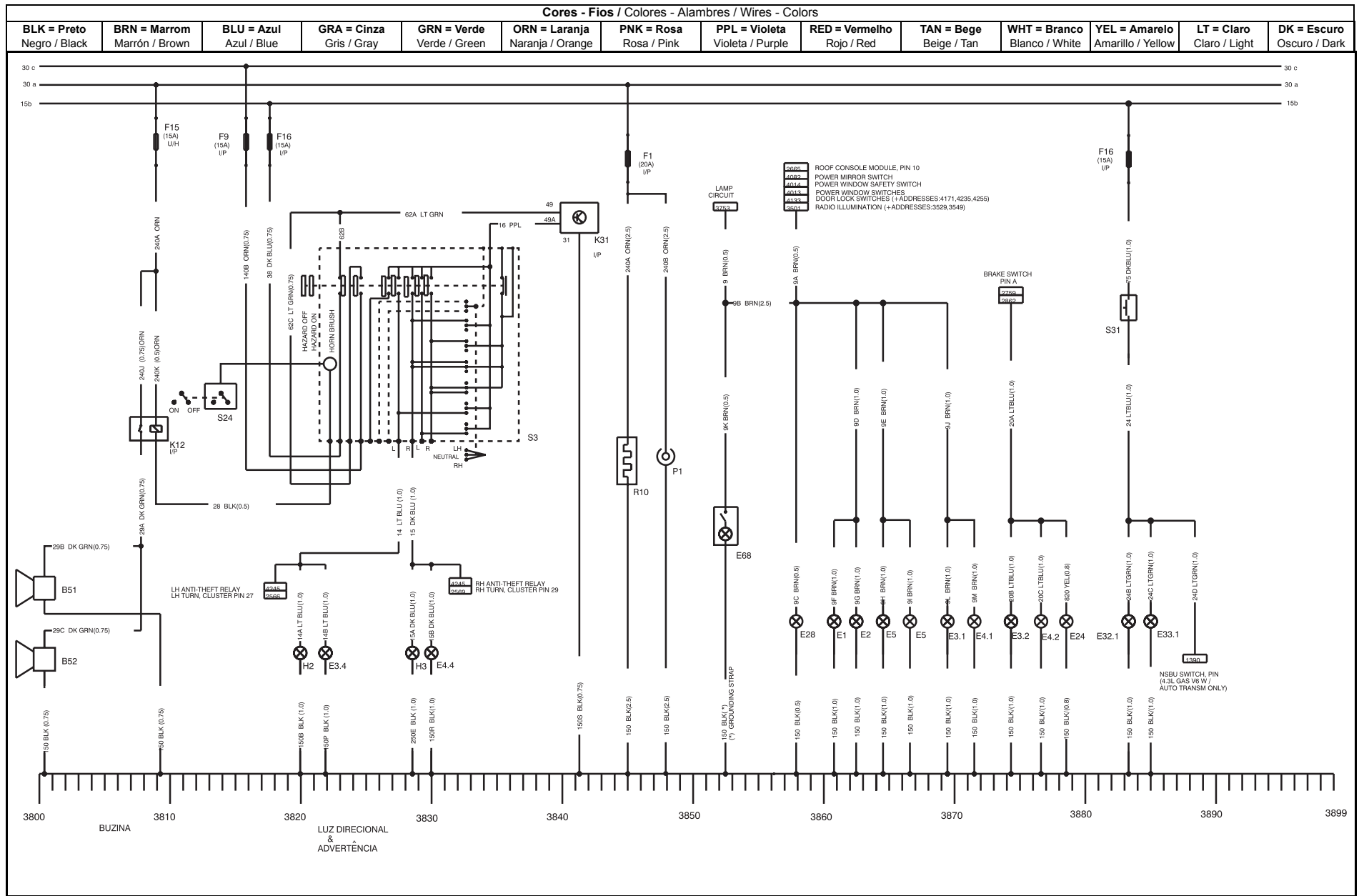

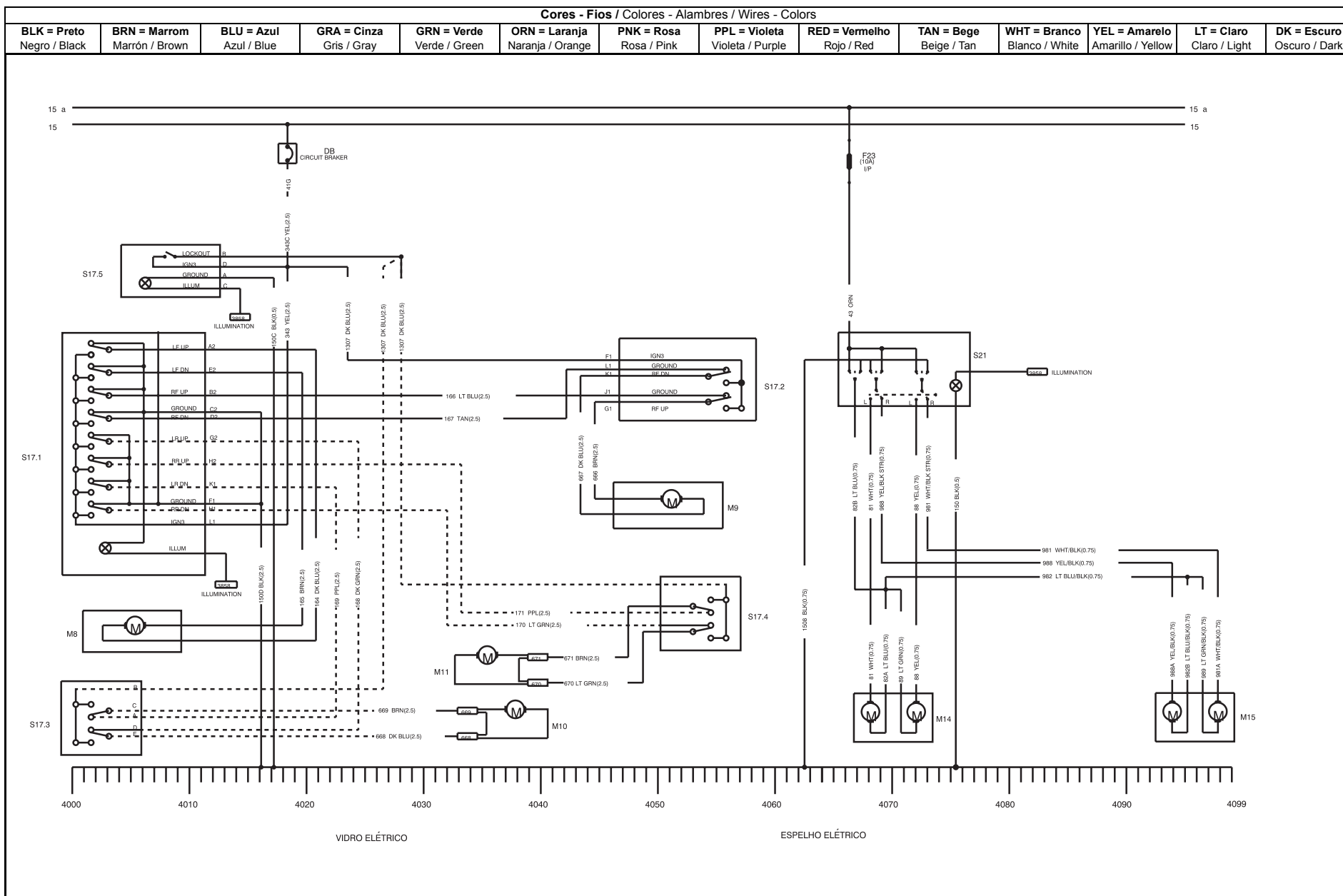

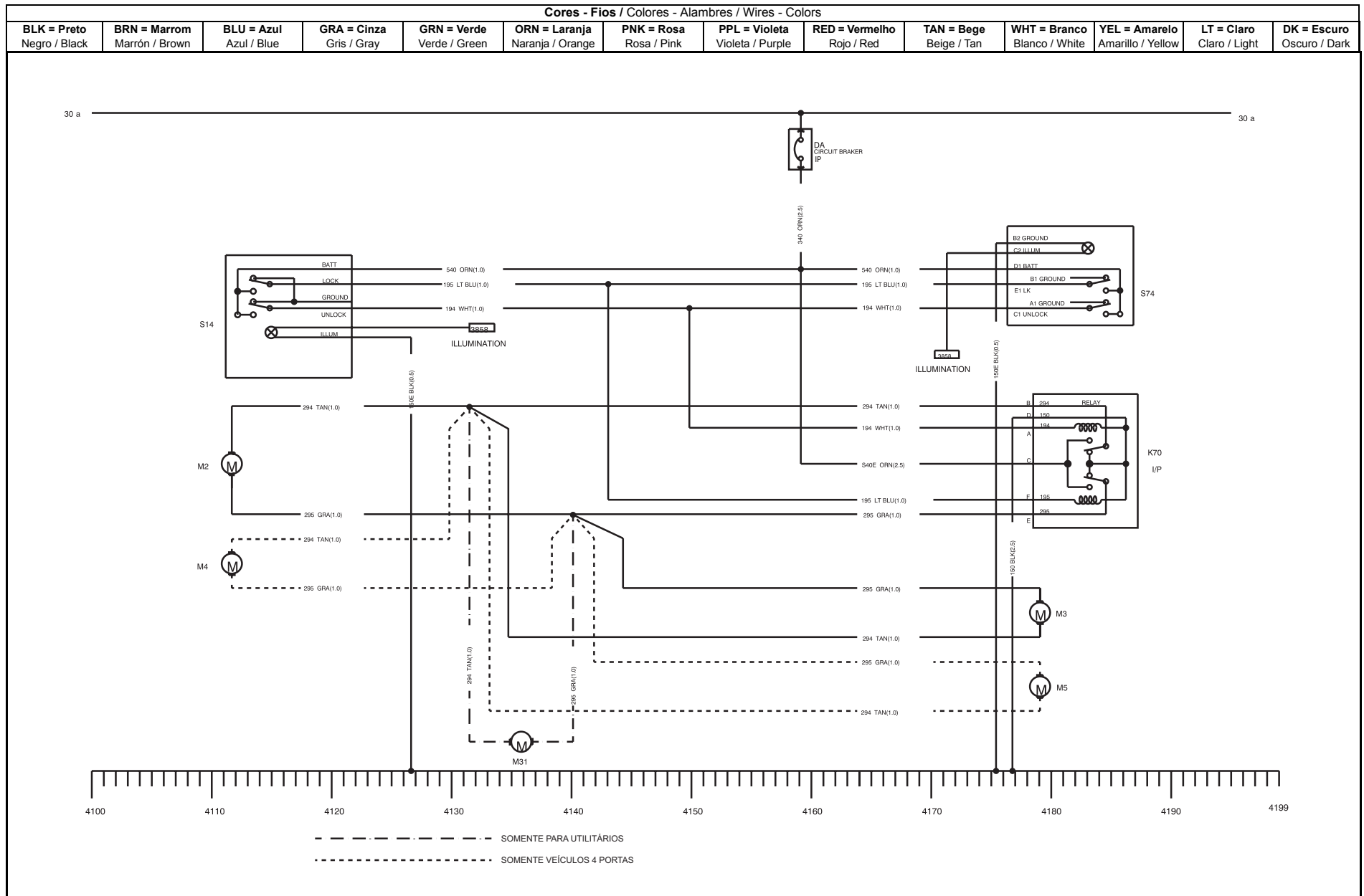

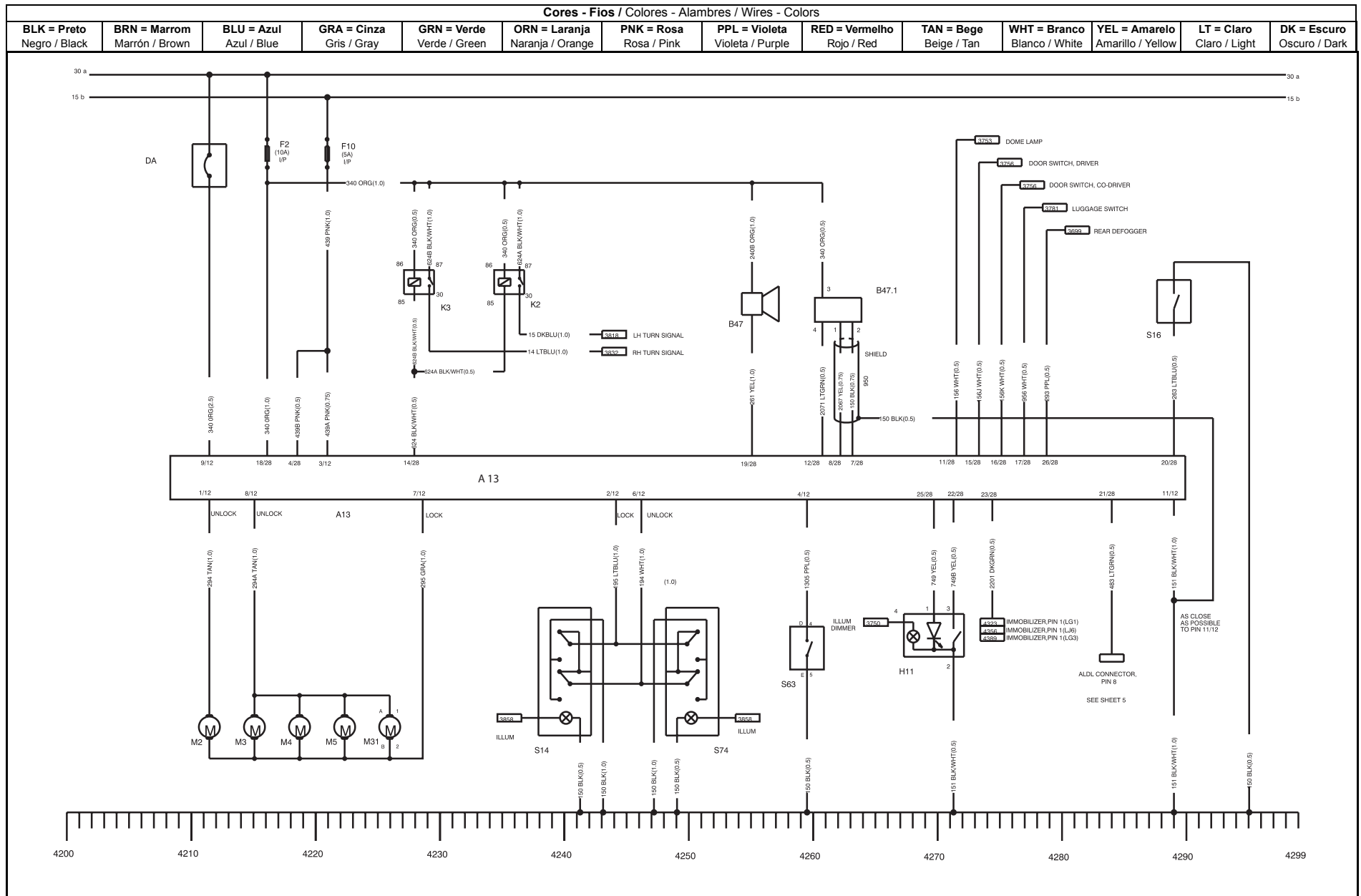

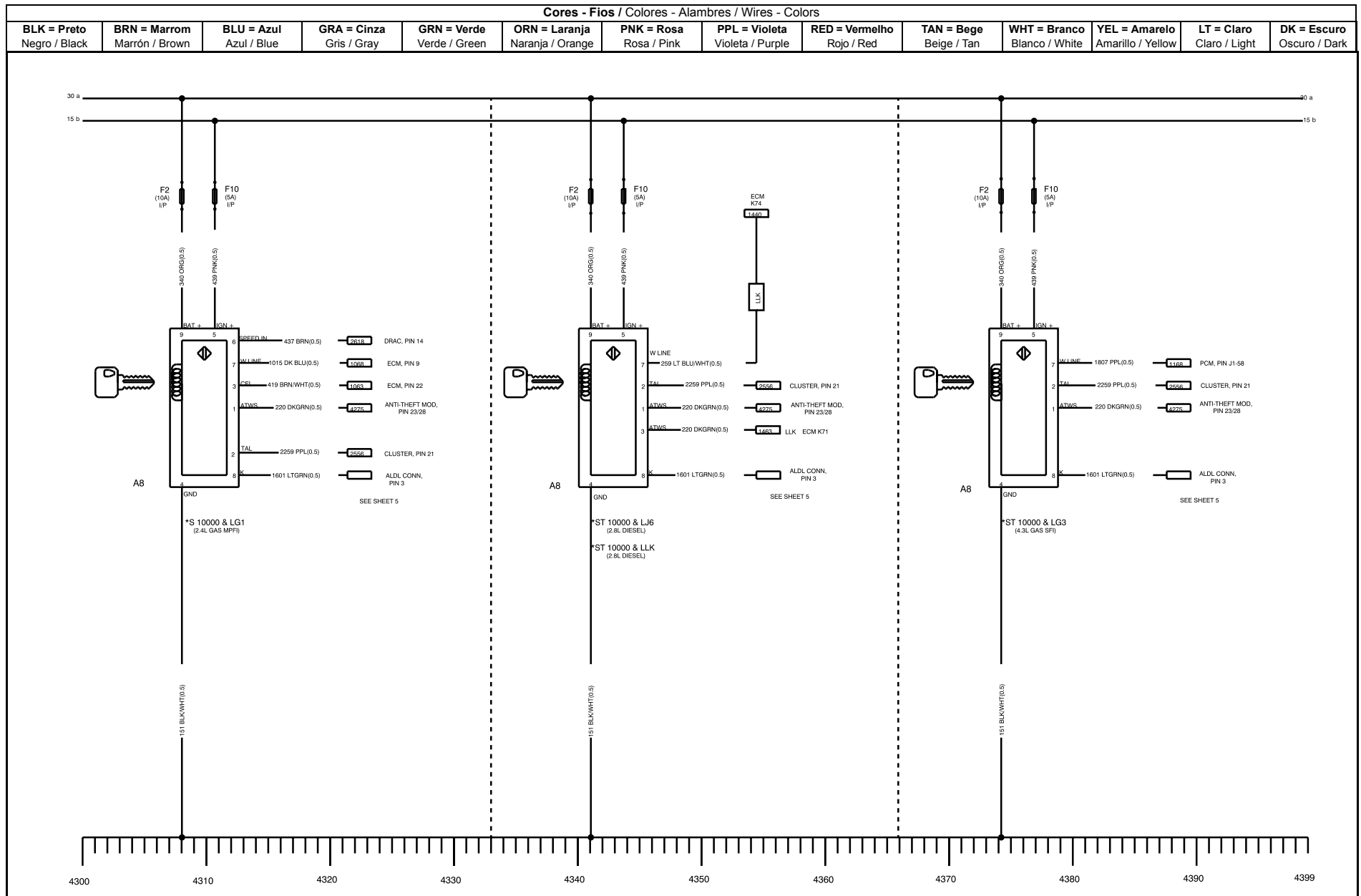

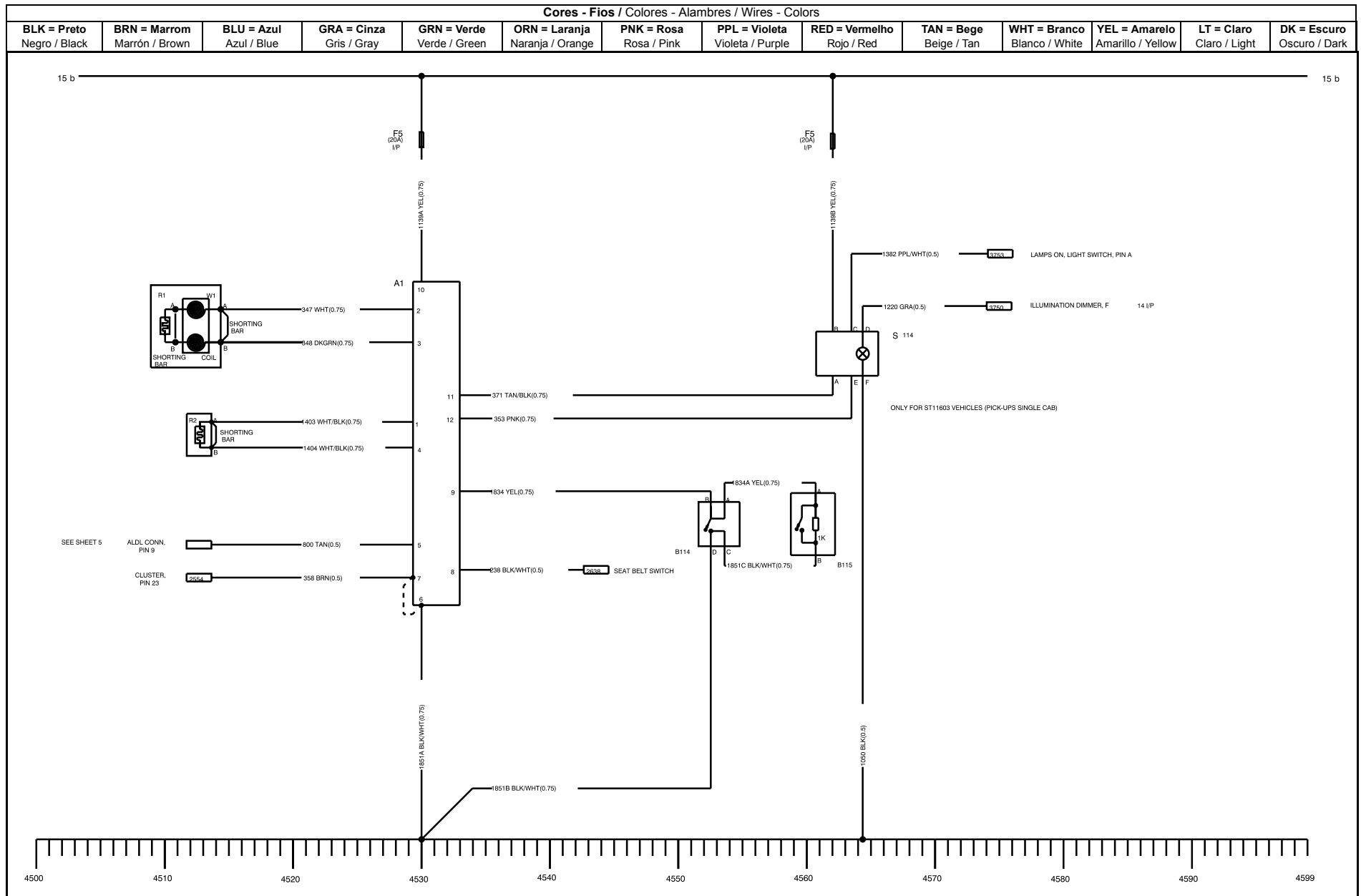

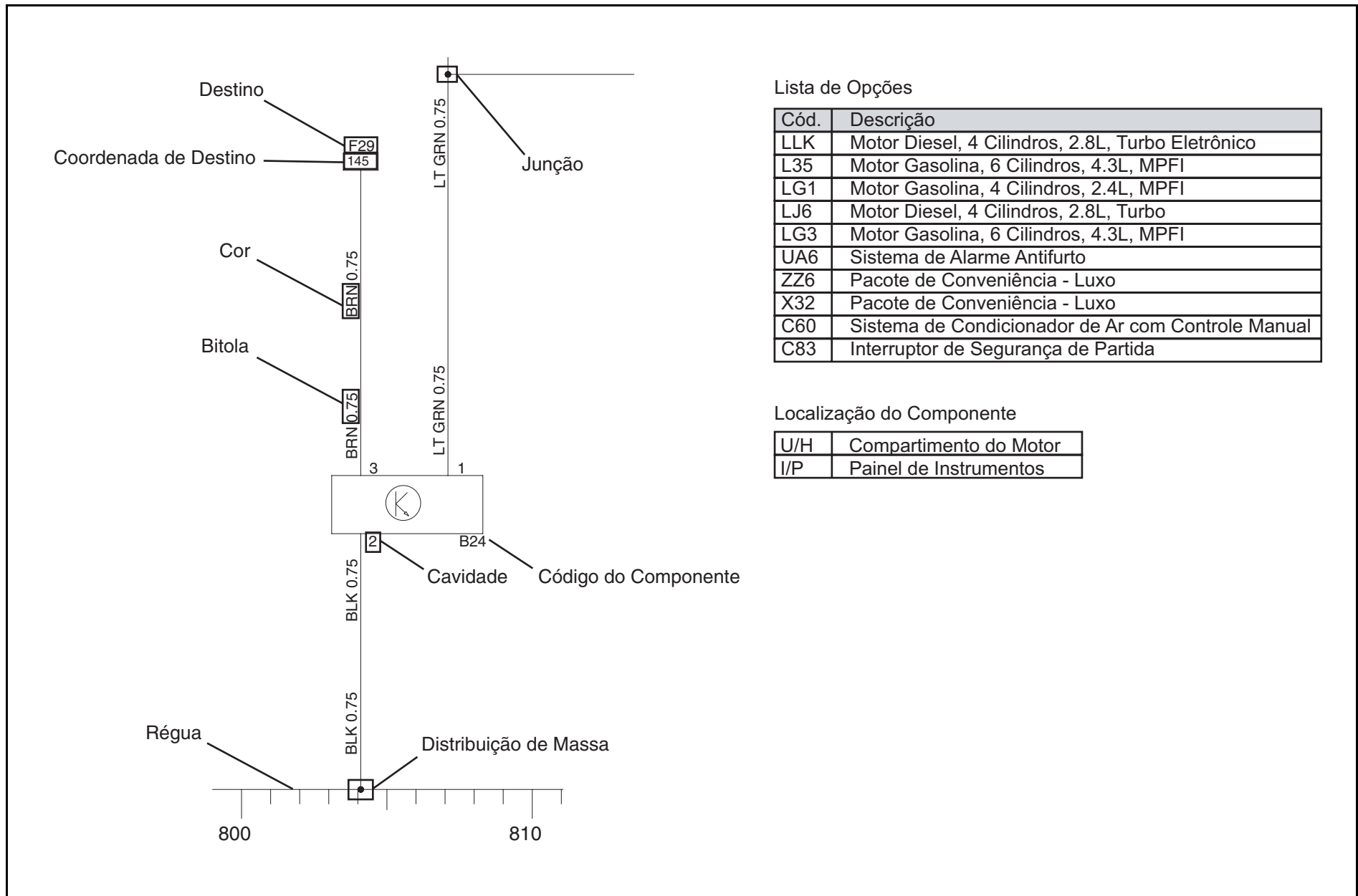

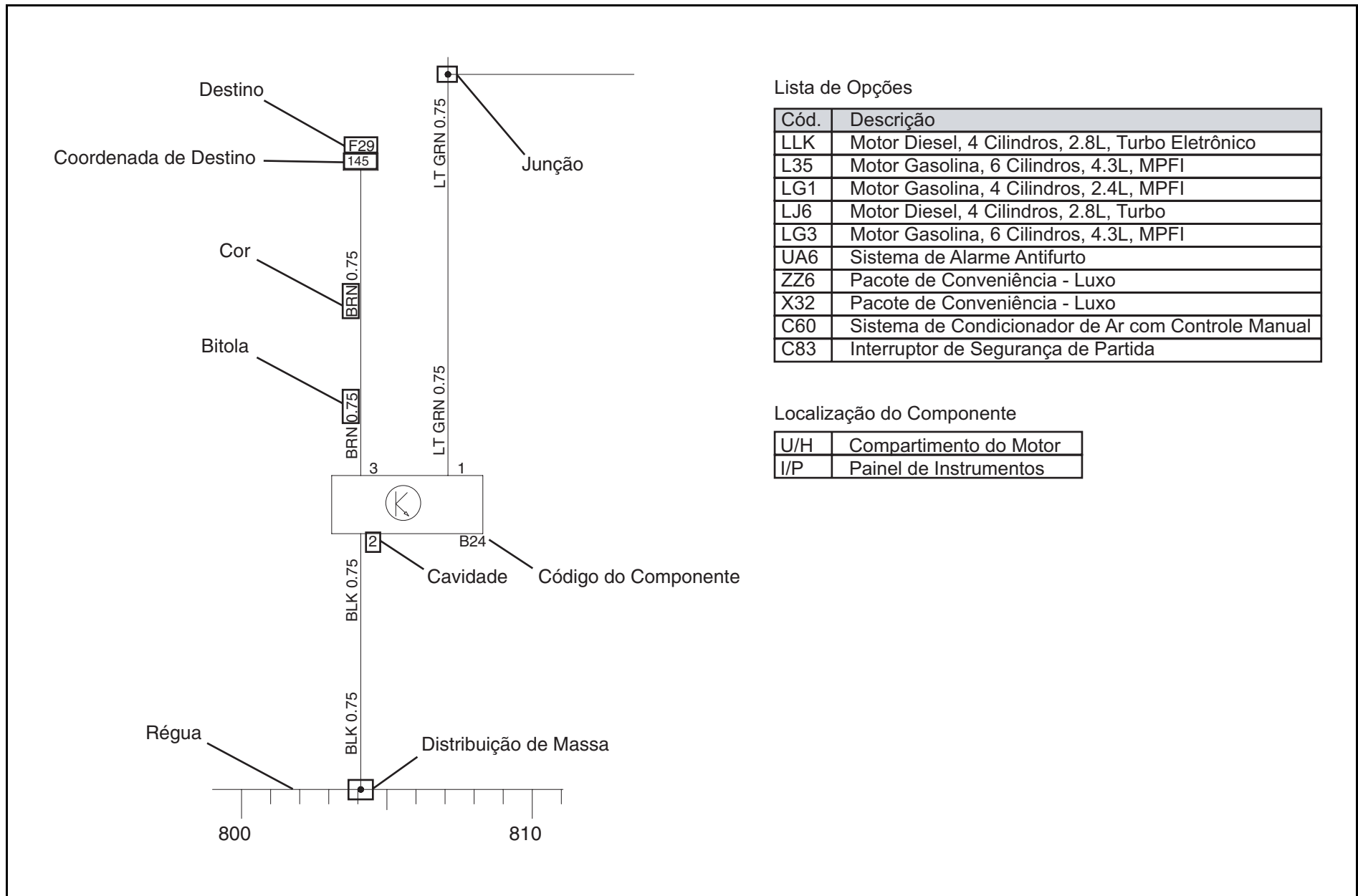

Cores - Fios / Colores - Alambres / Wires - Colors

BLK = Preto Negro / Black	BRN = Marrom Marrón / Brown	BLU = Azul Azul / Blue	GRA = Cinza Gris / Gray	GRN = Verde Verde / Green	ORN = Laranja Naranja / Orange	PNK = Rosa Rosa / Pink	PPL = Violeta Violeta / Purple	RED = Vermelho Rojo / Red	TAN = Bege Beige / Tan	WHT = Branco Blanco / White	YEL = Amarelo Amarillo / Yellow	LT = Claro Claro / Light	DK = Escuro Oscuro / Dark
------------------------------	--------------------------------	---------------------------	----------------------------	------------------------------	-----------------------------------	---------------------------	-----------------------------------	------------------------------	---------------------------	--------------------------------	------------------------------------	-----------------------------	------------------------------

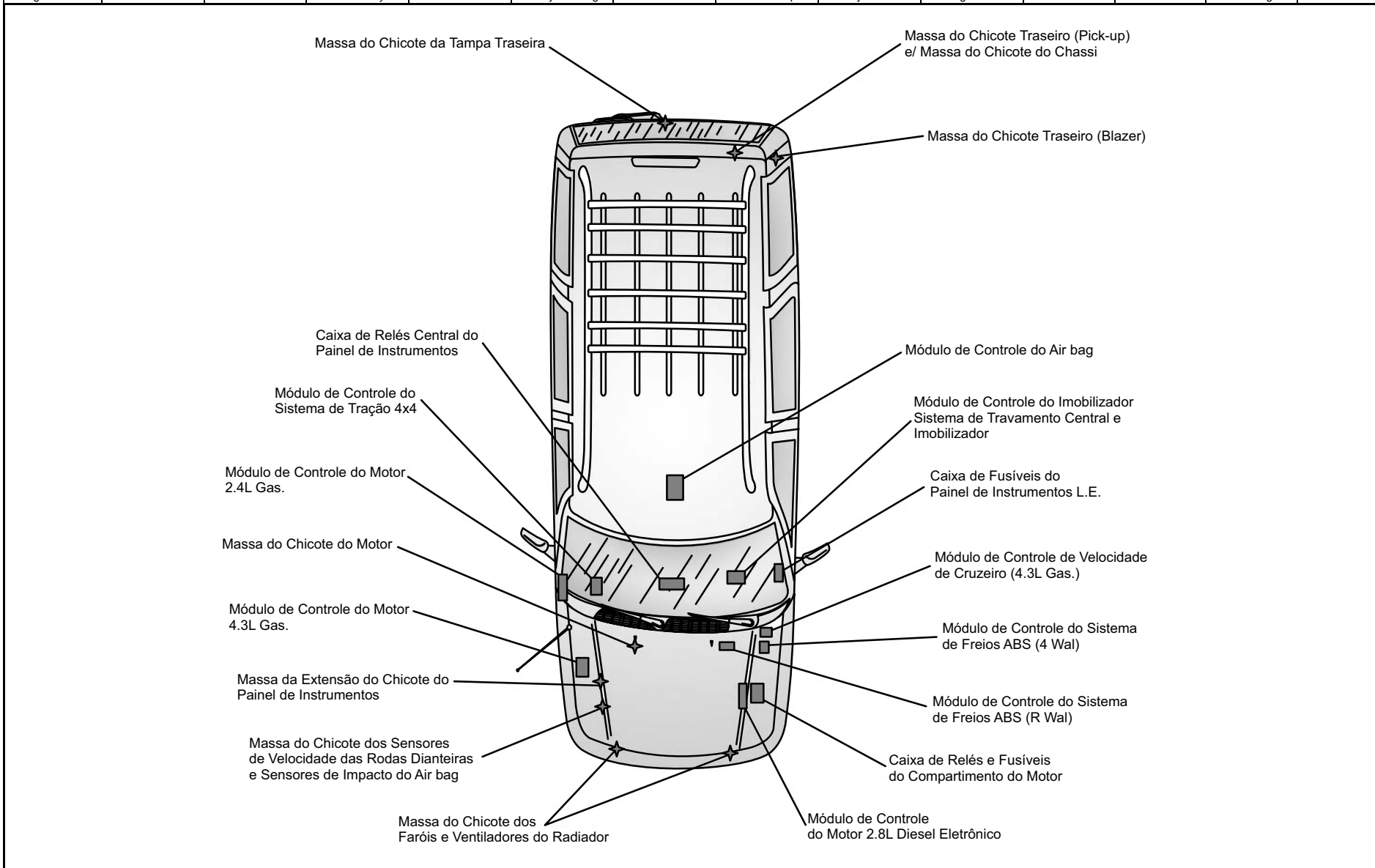

Cores - Fios / Cores - Alambres / Wires - Colors

BLK = Preto Negro / Black	BRN = Marrom Marrón / Brown	BLU = Azul Azul / Blue	GRA = Cinza Gris / Gray	GRN = Verde Verde / Green	ORN = Laranja Naranja / Orange	PNK = Rosa Rosa / Pink	PPL = Violeta Violeta / Purple	RED = Vermelho Rojo / Red	TAN = Bege Beige / Tan	WHT = Branco Blanco / White	YEL = Amarelo Amarillo / Yellow	LT = Claro Claro / Light	DK = Escuro Oscuro / Dark
-------------------------------------	---------------------------------------	----------------------------------	-----------------------------------	-------------------------------------	--	----------------------------------	--	-------------------------------------	----------------------------------	---------------------------------------	---	------------------------------------	-------------------------------------

FUSÍVEL	TIPO	CAPAC.	POSIÇÃO	DESCRIÇÃO
MF01	MAXIFUSÍVEL	30A	UIH	FUSÍVEL DO VENTILADOR DE ARREFECIMENTO-BAIXA VELOCIDADE
MF02	MAXIFUSÍVEL	30A	UIH	FUSÍVEL DO VENTILADOR DE ARREFECIMENTO-ALTA VELOCIDADE
MF03	MAXIFUSÍVEL	60A	UIH	FUSÍVEL DO CIRCUITO PRINCIPAL 30a
MF04	MAXIFUSÍVEL	60A	UIH	FUSÍVEL DO RELÉ AUXILIAR DE PARTIDA
MF05	MAXIFUSÍVEL	30A/60A	UIH	FUSÍVEL DO CIRCUITO PRINCIPAL 30b / FUSÍVEL DAS VELAS AQUECEDORAS
MF06	MAXIFUSÍVEL	40A	UIH	FUSÍVEL DE VENTILAÇÃO INTERNA
MF07	MAXIFUSÍVEL	60A	UIH	FUSÍVEL DO MÓDULO DE FREIO ABAS NAS 4 RODAS 4WAL
MF08	MAXIFUSÍVEL	50A	UIH	FUSÍVEL DO CIRCUITO PRINCIPAL 30c
MF09	MAXIFUSÍVEL	50A	UIH	FUSÍVEL DO CIRCUITO PRINCIPAL 15b
MF10	MAXIFUSÍVEL	50A	UIH	FUSÍVEL DO CIRCUITOS PRINCIPAIS 15 E 15a

FUSÍVEL	TIPO	CAPAC.	POSIÇÃO	DESCRIÇÃO
F1	MINIFUSÍVEL	10A	UIH	FUSÍVEL: ECM (MPFI 2.4L) / RELÉ PRINCIPAL / SENSOR PRESSÃO DE ÓLEO
F2	MINIFUSÍVEL	10A	UIH	FUSÍVEL: RELÉ DE ARREFECIMENTO / INTERRUPTOR DO SOLENOIDE (DIESEL 2.8L)
F3	MINIFUSÍVEL	10A	UIH	FUSÍVEL: ECM (MPFI 2.4 L) / RELÉ DA BOMBA DE COMBUSTÍVEL
F4	MINIFUSÍVEL	10A	UIH	FUSÍVEL: PCM / CANISTER / AQUECEDOR
F5	MINIFUSÍVEL	20A	UIH	FUSÍVEL: PCM / BOMBA DE IGNIÇÃO / MAF / INJETORES
F6	MINIFUSÍVEL	15A	UIH	FUSÍVEL: PCM / BOMBA DE COMBUSTÍVEL / SENSOR DE ÓLEO
F7	MINIFUSÍVEL	10A	UIH	FUSÍVEL: RELÉ PARTIDA
F8	MINIFUSÍVEL	-	UIH	FUSÍVEL: LIVRE
F9	MINIFUSÍVEL	-	UIH	FUSÍVEL: LIVRE
F10	MINIFUSÍVEL	-	UIH	FUSÍVEL: LIVRE
F11	MINIFUSÍVEL	25A	UIH	FUSÍVEL: RELÉ DO AR CONDICIONADO
F12	MINIFUSÍVEL	10A	UIH	FUSÍVEL: MÓDULO ABS RODAS TRASEIRA (RWAL)
F13	MINIFUSÍVEL	20A	UIH	FUSÍVEL: MÓDULO ABS RODAS TRASEIRA (RWAL)
F14	MINIFUSÍVEL	25A	UIH	FUSÍVEL: COMPRESSOR DO AR CONDICIONADO (4.3L V6)
F15	MINIFUSÍVEL	15A	UIH	FUSÍVEL: BUZINA
F16	MINIFUSÍVEL	20A	UIH	FUSÍVEL: FAROL BAIXO
F17	MINIFUSÍVEL	20A	UIH	FUSÍVEL: FAROL ALTO
F18	MINIFUSÍVEL	10A	UIH	FUSÍVEL: MÓDULO DE CONTROLE AUTOMÁTICO

FUSÍVEL	POSIÇÃO	DESCRIÇÃO
K8	UIH	RELÉ DOS FARÓIS BAIXO ALL
K8	UIH	RELÉ DOS FARÓIS ALTO &LG1 / &LG3
K13	UIH	RELÉ DE ALTA VELOCIDADE DO VENTILADOR DE ARREFECIMENTO &LG1 / &LLK
K14	UIH	RELÉ DE BAIXA VELOCIDADE DO VENTILADOR DE ARREFECIMENTO &LG1 / &LLK
K14.1	UIH	RELÉ SÉRIE-PARALELO DO VENTILADOR DE ARREFECIMENTO &LG1
K18	UIH	RELÉ PRINCIPAL DO SISTEMA DE INJEÇÃO MPFI &LG1
K24	UIH	RELÉ AUXILIAR DE PARTIDA &LG1 / &LG3
K36	UIH	RELÉ DO COMPRESSOR DE A/C &C60 / &LLK
K43	UIH	RELÉ DE VENTILAÇÃO INTERNA &LG1 / &LG3
K72	UIH	RELÉ DE FALHA DO SISTEMA ABS &J41 / &J44 / &LLK
K80	UIH	RELÉ PRINCIPAL &LLK

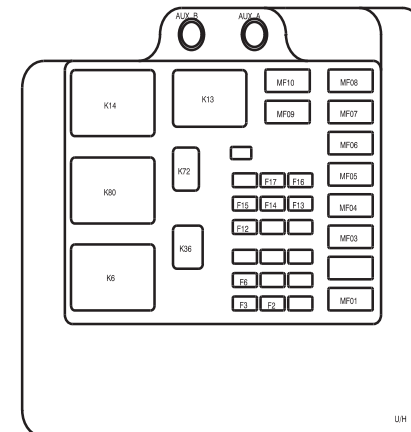
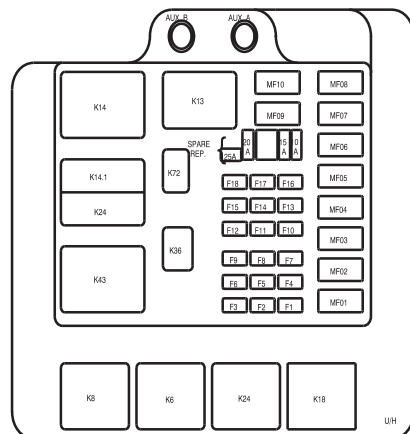

Cores - Fios / Colores - Alambres / Wires - Colors

BLK = Preto Negro / Black	BRN = Marrom Marrón / Brown	BLU = Azul Azul / Blue	GRA = Cinza Gris / Gray	GRN = Verde Verde / Green	ORN = Laranja Naranja / Orange	PNK = Rosa Rosa / Pink	PPL = Violeta Violeta / Purple	RED = Vermelho Rojo / Red	TAN = Bege Beige / Tan	WHT = Branco Blanco / White	YEL = Amarelo Amarillo / Yellow	LT = Claro Claro / Light	DK = Escuro Oscuro / Dark
------------------------------	--------------------------------	---------------------------	----------------------------	------------------------------	-----------------------------------	---------------------------	-----------------------------------	------------------------------	---------------------------	--------------------------------	------------------------------------	-----------------------------	------------------------------

RELÉ	DESCRICAÇÃO	USO
K2	RELÉ DO ALARME - INDICADOR DIREÇÃO LD	& UA6
K3	RELÉ DO ALARME - INDICADOR DIREÇÃO LE	& UA6
K12	RELÉ DE ACIONAMENTO DA BUZINA	TODOS
K16	RELÉ DA BOMBA DE COMBUSTÍVEL	&LG1 / &LG3 / &LLK
K31	RELÉ DOS INDICADORES DE DIREÇÃO (BLINKER)	TODOS
K37	RELÉ MOTOR LIGADO	&LG3
K40	RELÉ LIMPADOR E LAVADOR DO VIDRO TRASEIRO	ST11506
K70	RELÉ MÓDULO DAS TRAVAS DAS PORTAS	&X32 / &ZZ6 - UA6
K73	RELÉ DOS FARÓIS AUXILIARES DE NEBLINA	&X32 / &ZZ6 / &UOM
H9	MÓDULO INTERNO DE ALARME (CHIME)	TODOS

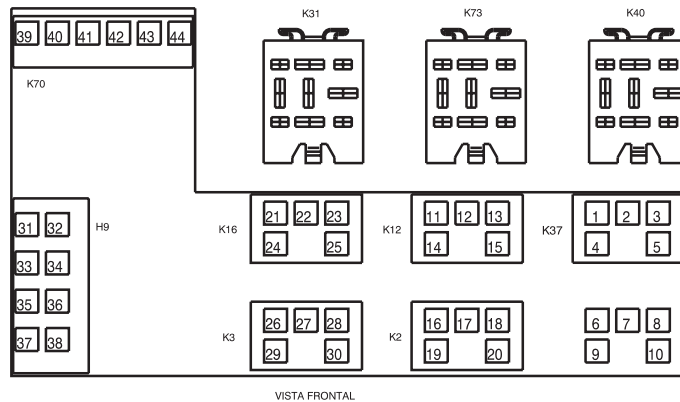

Cores - Fios / Cores - Alambres / Wires - Colors

BLK = Preto Negro / Black	BRN = Marrom Marrón / Brown	BLU = Azul Azul / Blue	GRA = Cinza Gris / Gray	GRN = Verde Verde / Green	ORN = Laranja Naranja / Orange	PNK = Rosa Rosa / Pink	PPL = Violeta Violeta / Purple	RED = Vermelho Rojo / Red	TAN = Bege Beige / Tan	WHT = Branco Blanco / White	YEL = Amarelo Amarillo / Yellow	LT = Claro Claro / Light	DK = Escuro Oscuro / Dark
------------------------------	--------------------------------	---------------------------	----------------------------	------------------------------	-----------------------------------	---------------------------	-----------------------------------	------------------------------	---------------------------	--------------------------------	------------------------------------	-----------------------------	------------------------------

FUSÍVEL	TIPO	POSIÇÃO	DESCRIÇÃO
F1	MINIFUSÍVEL	20A	I/P FUSÍVEL: ACENDEDOR DE CIGARROS (E TOMADA DE FORÇA 12V)
F2	MINIFUSÍVEL	10A	I/P FUSÍVEL: MÓDULO ALARME ANTI-FURTO
F3	MINIFUSÍVEL	20A	I/P FUSÍVEL: ILUMINAÇÃO: LANTERNAS TRAS. / PLACA DE LICENÇA / ACENDEDOR DE CIGARROS / SISTEMA DE SOM / INTERIOR CAPUZ / LUZ DO TETO / INTERRUPTOR DE ILUMINAÇÃO / LUZES DE ESTACIONAMENTO
F4	MINIFUSÍVEL	20A	I/P FUSÍVEL: PAINEL DE INSTRUMENTOS / MÓDULO 4X4 / 4X4 - INTERRUPTOR DO EIXO DIANT.
F5	MINIFUSÍVEL	20A	I/P FUSÍVEL: MÓDULO AIR BAG (DUPLO)
F6	MINIFUSÍVEL	25A	I/P FUSÍVEL: VENTILAÇÃO / AR CONDICIONADO
F7	MINIFUSÍVEL	25A	I/P FUSÍVEL: ALDL
F8	MINIFUSÍVEL	30A	I/P FUSÍVEL: DESEMBAÇADOR TRASEIRO
F9	MINIFUSÍVEL	15A	I/P FUSÍVEL: LUZES DE ALERTA / INTERRUPTOR DO FREIO / MÓDULO DE ALARME INTERNO
F10	MINIFUSÍVEL	5A	I/P FUSÍVEL: MÓDULO IMOBILIZADOR DE IGNIÇÃO & PARTIDA / MÓDULO DE ALARME
F11	MINIFUSÍVEL	20A	I/P FUSÍVEL: INTERRUPTOR NSBU (4.3L V6 AT)
F12	MINIFUSÍVEL	15A	I/P FUSÍVEL: DRAC / MÓDULO DE ALARME INTERNO / INTERRUPTOR DO FREIO (ABS)
F13	MINIFUSÍVEL	10A	I/P FUSÍVEL: SISTEMA DE SOM
F14	MINIFUSÍVEL	10A	I/P FUSÍVEL: REDUTOR DE TENSÃO
F15	MINIFUSÍVEL	20A	I/P FUSÍVEL: FAROL DE NEBLINA / LANTERNA TRASEIRA DE NEBLINA
F16	MINIFUSÍVEL	15A	I/P FUSÍVEL: INDICADOR DE DIREÇÃO / LUZES DE RÉ / NSBU INTERRUPTOR (4.3L V6 AT)
F17	MINIFUSÍVEL	25A	I/P FUSÍVEL: LIMPADOR E LAVADOR DIANTEIRO
F18	MINIFUSÍVEL	10A	I/P FUSÍVEL: COMANDO DE FARÓIS
F19	MINIFUSÍVEL	20A	I/P FUSÍVEL: MÓDULO 4X4
F20	MINIFUSÍVEL	-	I/P LIVRE
F21	MINIFUSÍVEL	10A	I/P FUSÍVEL: LUZ DE CORTESIA / ILLUM. CONSOLE DO TETO / LUZ DE LEITURA / PAINEL DE INSTRUMENTOS
F22	MINIFUSÍVEL	25A	I/P FUSÍVEL: LIMPADOR E LAVADOR TRASEIRO
F23	MINIFUSÍVEL	10A	I/P FUSÍVEL: ESPELHO ELÉTRICO / ILLUM. CONSOLE DO TETO / INTERRUPTOR DO LIMPADOR E LAVADOR TRASEIRO / DESEMBAÇADOR TRASEIRO / RÁDIO
F24	MINIFUSÍVEL	-	I/P LIVRE
DA	DISJUNTOR	I/P	DISJUNTOR: TRAVA ELÉTRICA DAS PORTAS
DB	DISJUNTOR	I/P	DISJUNTOR: LEVANTADOR DO VIDRO ELÉTRICO

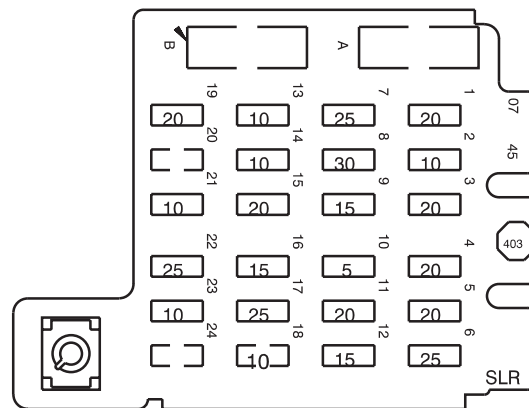

VISTA FRONTAL



Cores - Fios / Colores - Alambres / Wires - Colors

BLK = Preto Negro / Black	BRN = Marrom Marrón / Brown	BLU = Azul Azul / Blue	GRA = Cinza Gris / Gray	GRN = Verde Verde / Green	ORN = Laranja Naranja / Orange	PNK = Rosa Rosa / Pink	PPL = Violeta Violeta / Purple	RED = Vermelho Rojo / Red	TAN = Bege Beige / Tan	WHT = Branco Blanco / White	YEL = Amarelo Amarillo / Yellow	LT = Claro Claro / Light	DK = Escuro Oscuro / Dark
------------------------------	--------------------------------	---------------------------	----------------------------	------------------------------	-----------------------------------	---------------------------	-----------------------------------	------------------------------	---------------------------	--------------------------------	------------------------------------	-----------------------------	------------------------------

LG1

	CIRCUITO	DESCRIÇÃO
1		
2	1807	MÓDULO ABS 4WAL PINO B6
3	1601	MÓDULO IMOBILIZADOR PINO 8
4	150	MASSA
5	151	MASSA
6	448	MÓDULO ECM PINO 13
7	461	MÓDULO ECM PINO 55
8	483	PAINEL DE INSTRUMENTOS PINO 9 / MÓDULO DO ALARME PINO 21/28
9	800	MÓDULO AIR BAG PINO 05
10		
11		
12	696	MÓDULO ABS RWAL PINO D / MÓDULO DRAC PINO 10
13		
14		
15		
16	840	FUSÍVEL 7 (25A)

LG3

	CIRCUITO	DESCRIÇÃO
1		
2	1807/799	MÓDULO ABS PINO B6 / MÓDULO IMOBILIZADOR PINO 7 / PCM PINO 5J-58 & J1-59
3	1601	MÓDULO IMOBILIZADOR PINO 8
4	150	MASSA
5	151	MASSA
6		
7		
8	483	PAINEL DE INSTRUMENTOS PINO 9 / MÓDULO ALARME PINO 21/28
9	800	MÓDULO AIRBAG PINO 5
10		
11		
12	696	MÓDULO ABS PINO D / MÓDULO ABS 4WAL PINO B1 / PCM PINO J2-49
13	1568	MÓDULO 4X4 PINO D3
14		
15		
16	840	FUSÍVEL 7 (25A)

LLK

	CIRCUITO	DESCRIÇÃO
1		
2	1807	MÓDULO ABS 4WAL PINO B6
3	1601	MÓDULO IMOBILIZADOR PINO 8
4	150	MASSA
5	151	MASSA
6		
7	448	MÓDULO ECM PINO 25
8	483	PAINEL DE INSTRUMENTOS PINO 9 / MÓDULO DO ALARME PINO 21/28
9	800	MÓDULO AIR BAG PINO 05
10		
11		
12	696	MÓDULO ABS RWAL PINO D / MÓDULO DRAC PINO 10
13	1568	MÓDULO 4X4 PINO D3
14		
15		
16	840	FUSÍVEL 7 (25A)



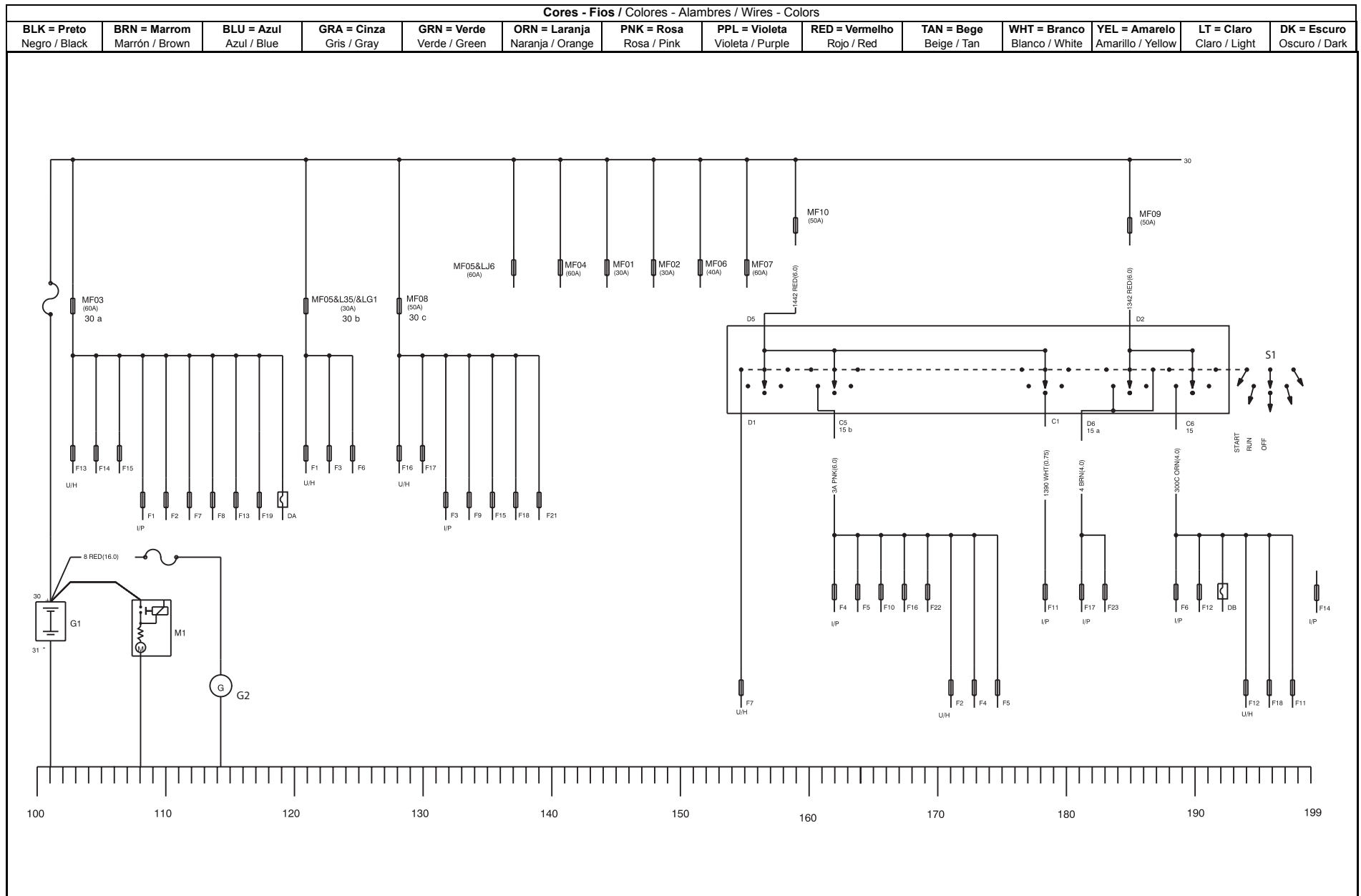

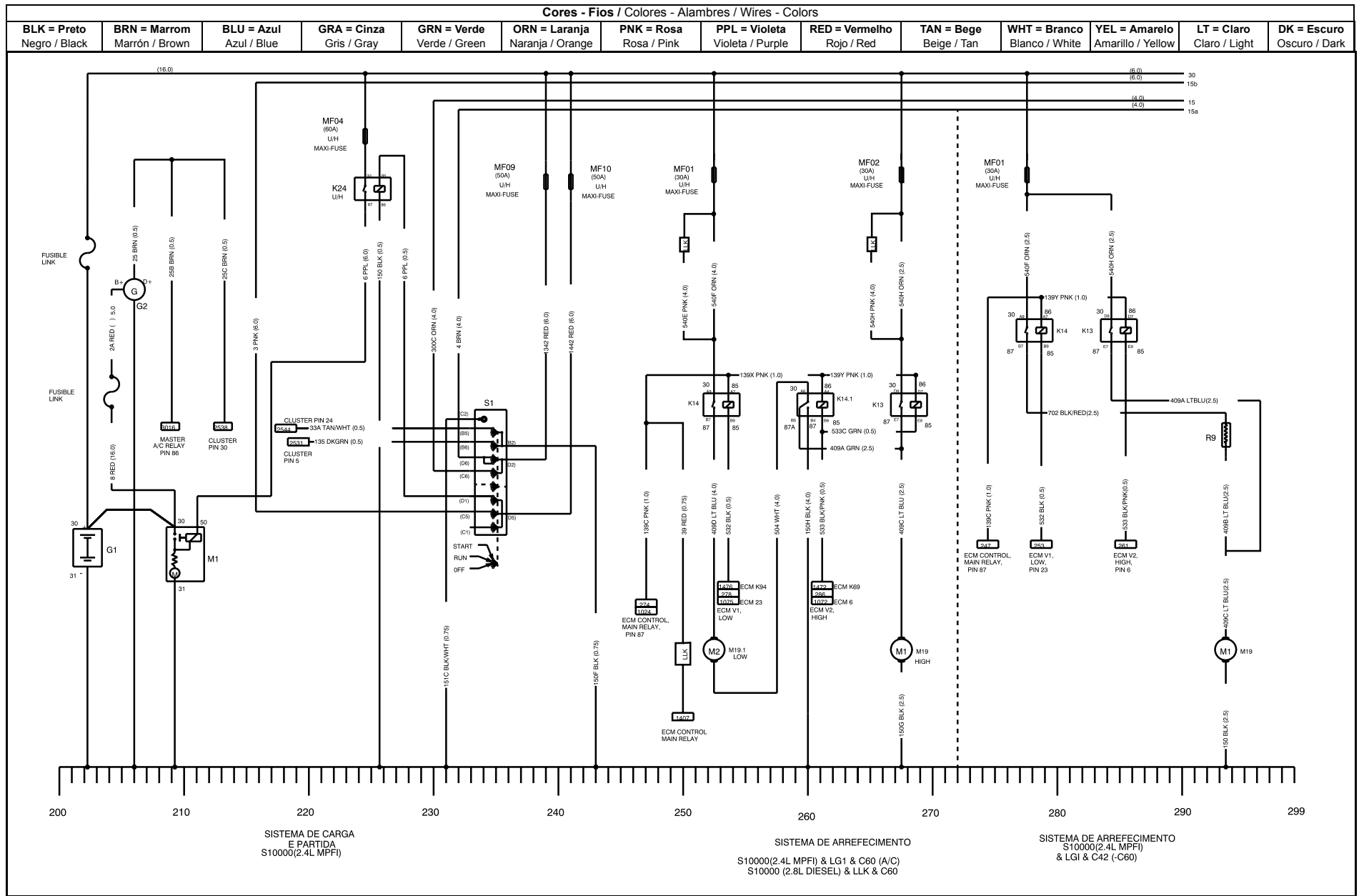

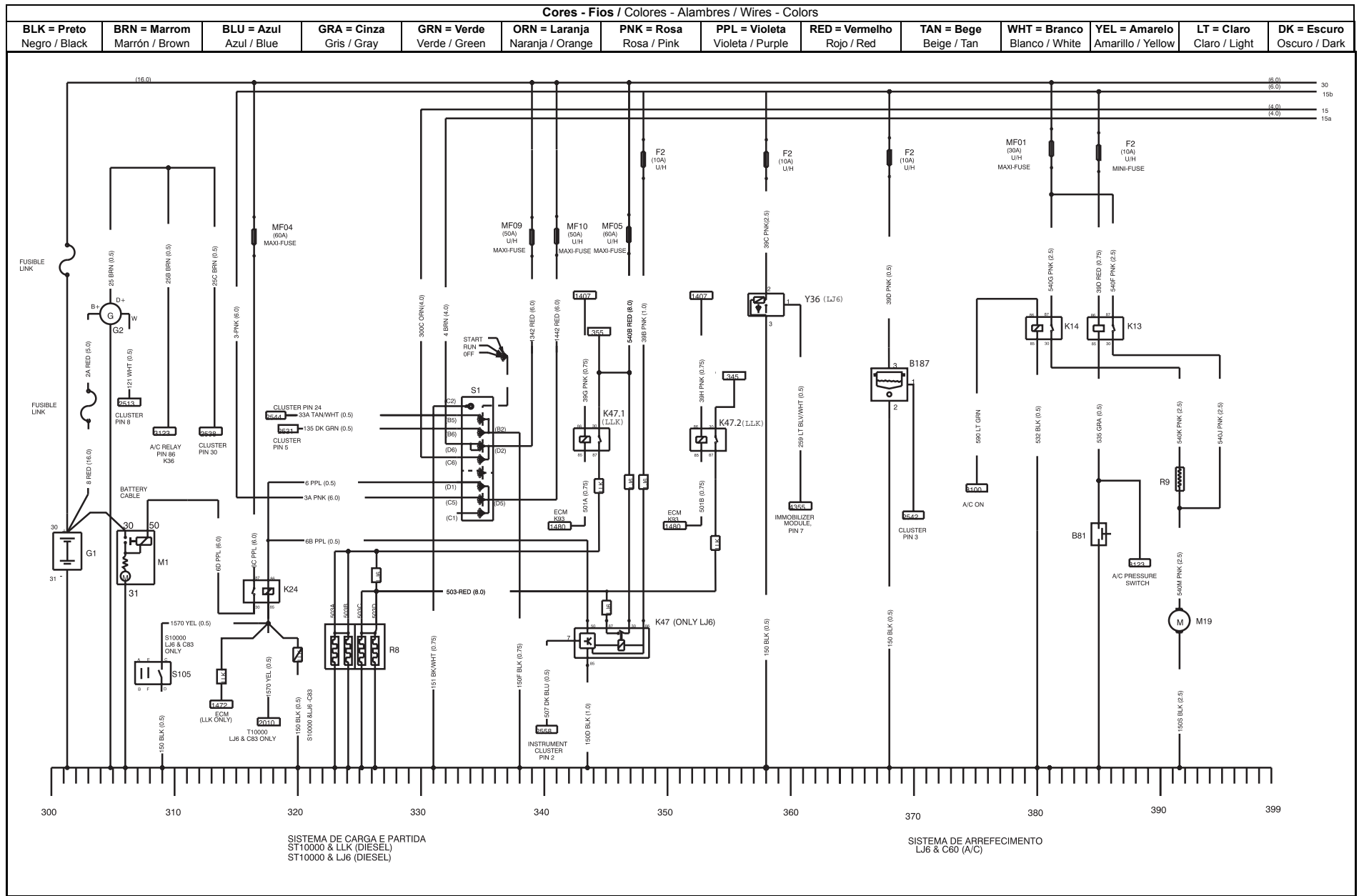

Cores - Fios / Cores - Alambres / Wires - Colors

BLK = Preto Negro / Black	BRN = Marrom Marrón / Brown	BLU = Azul Azul / Blue	GRA = Cinza Gris / Gray	GRN = Verde Verde / Green	ORN = Laranja Naranja / Orange	PNK = Rosa Rosa / Pink	PPL = Violeta Violeta / Purple	RED = Vermelho Rojo / Red	TAN = Bege Beige / Tan	WHT = Branco Blanco / White	YEL = Amarelo Amarillo / Yellow	LT = Claro Claro / Light	DK = Escuro Oscuro / Dark
-------------------------------------	---------------------------------------	----------------------------------	-----------------------------------	-------------------------------------	--	----------------------------------	--	-------------------------------------	----------------------------------	---------------------------------------	---	------------------------------------	-------------------------------------

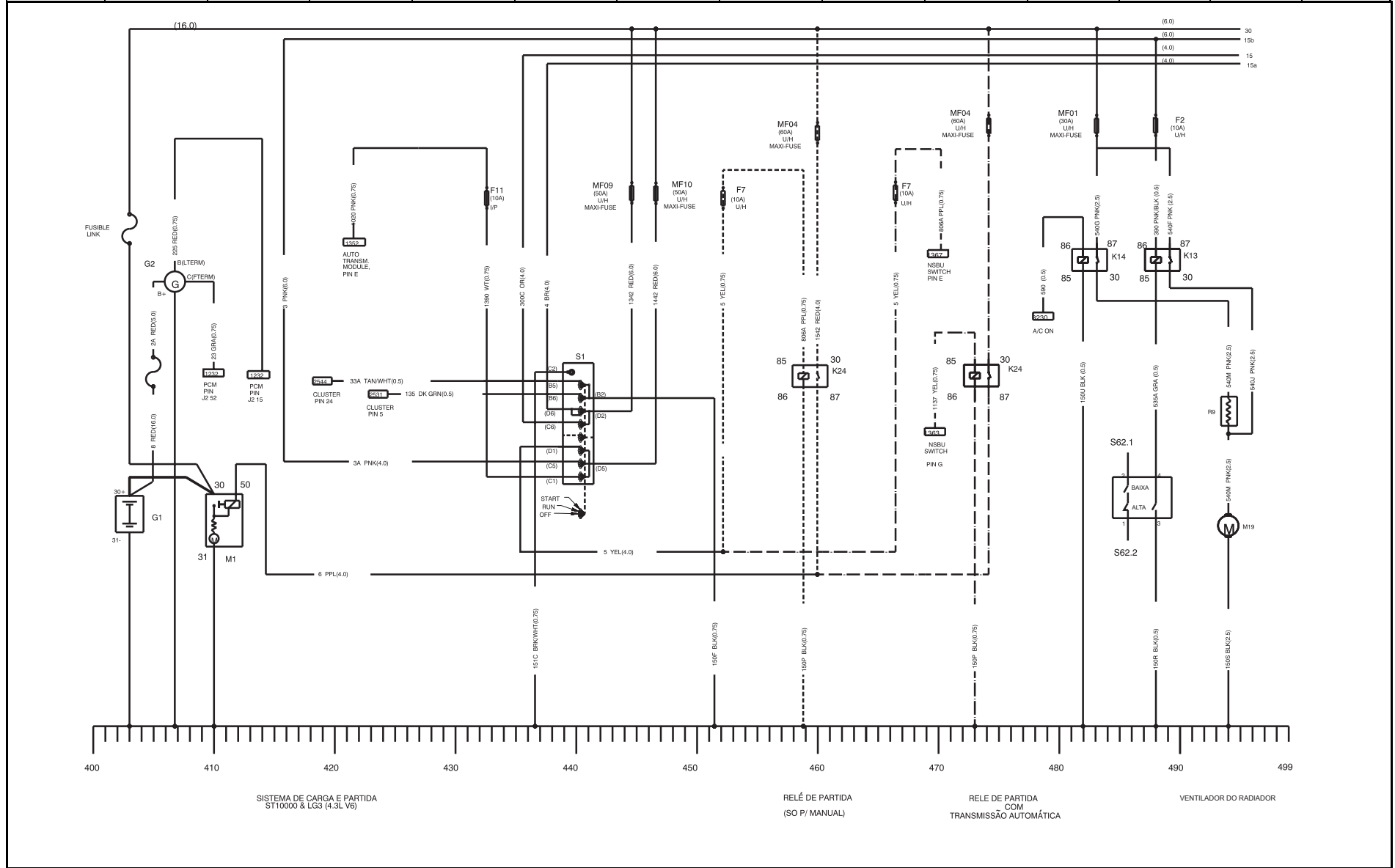

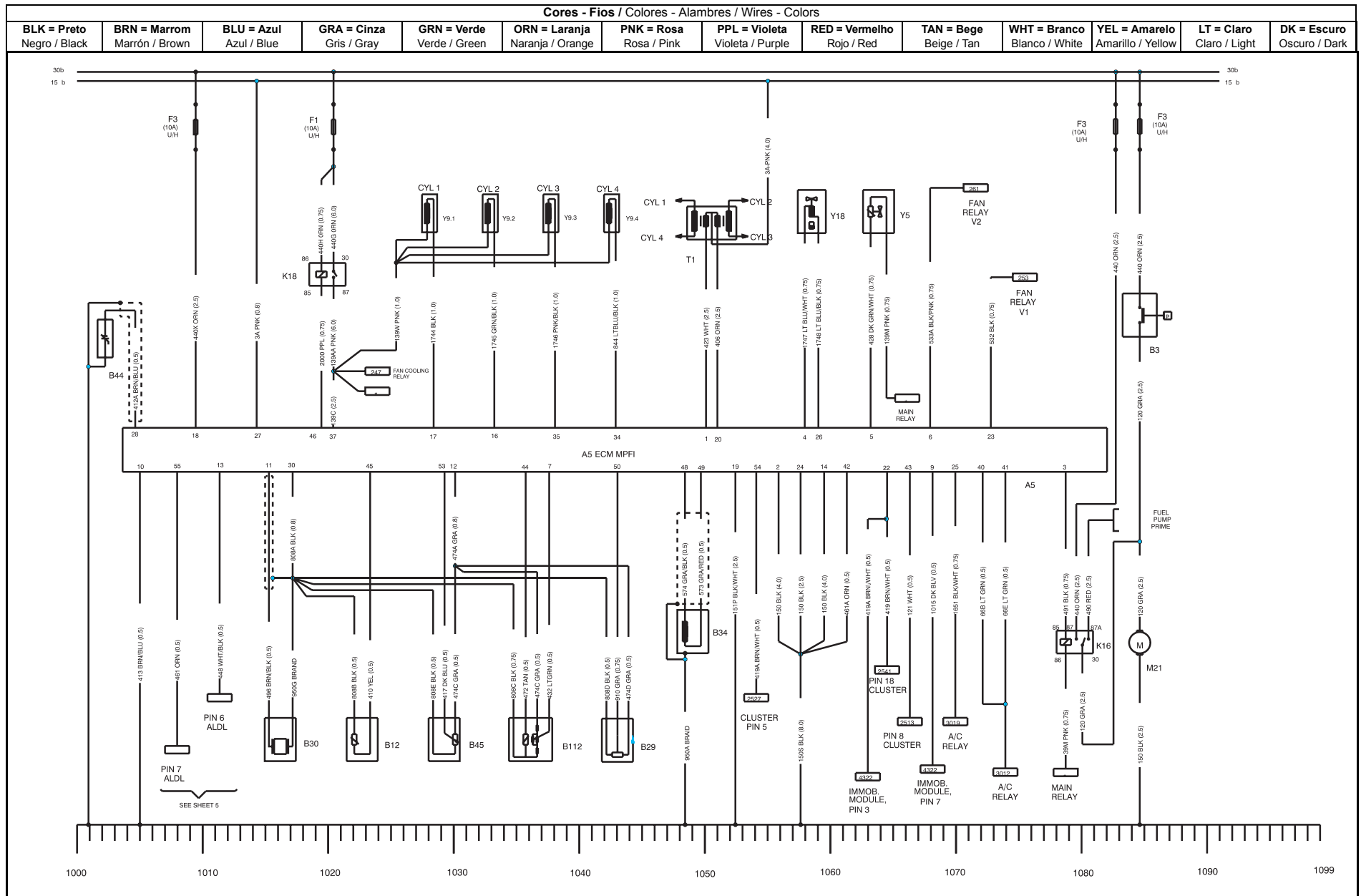

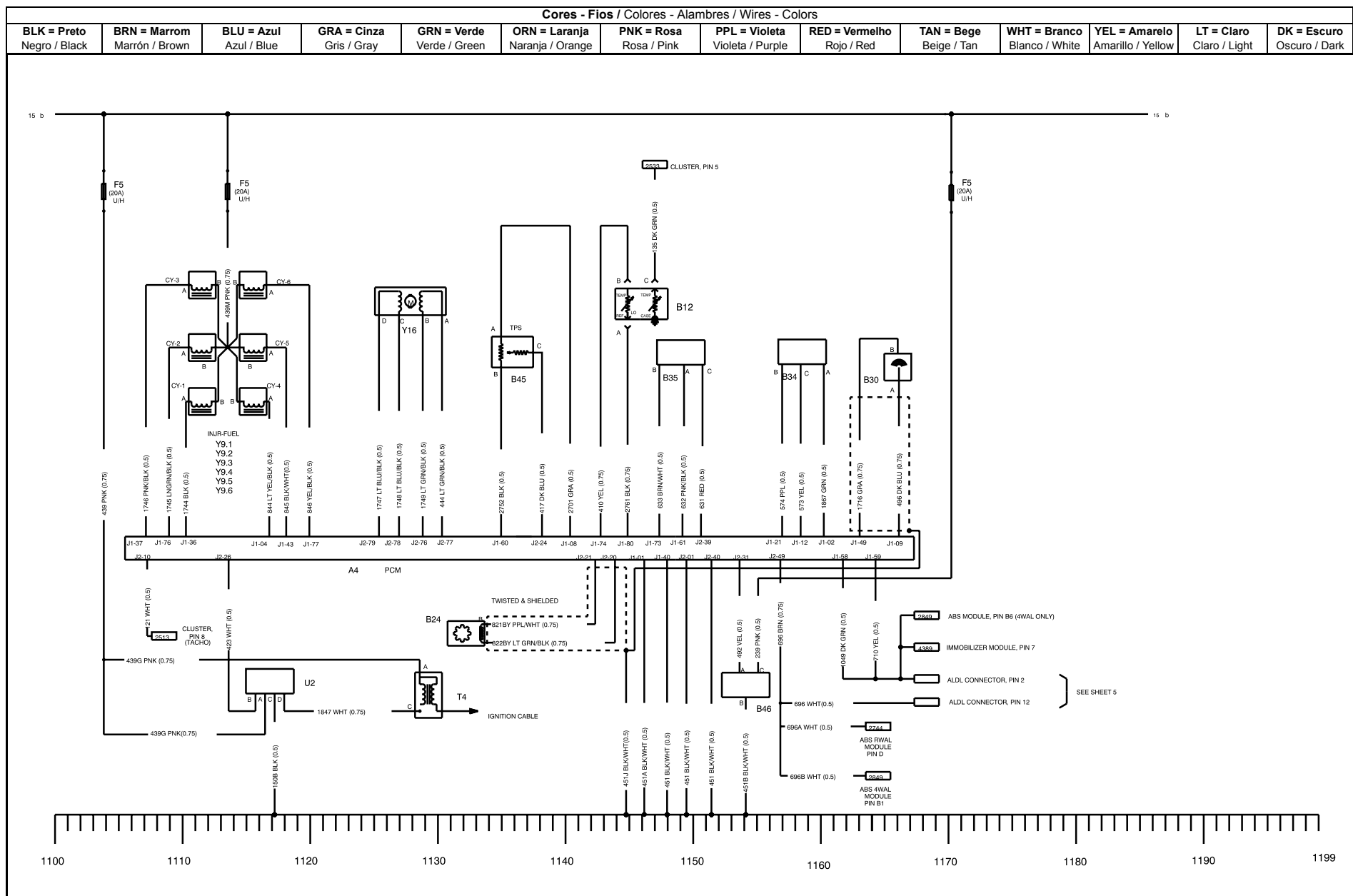

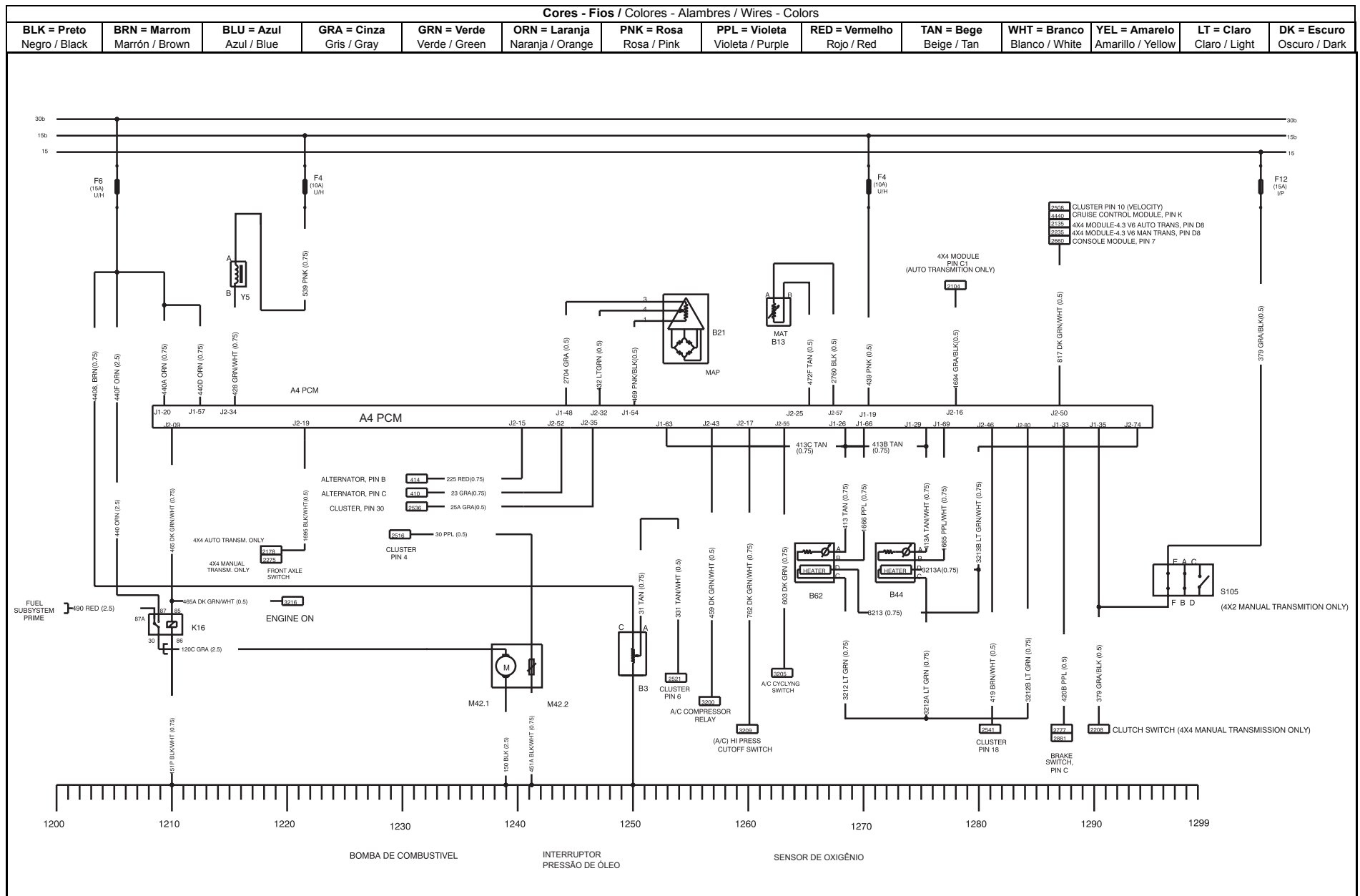

Cores - Fios / Cores - Alambres / Wires - Colors

BLK = Preto Negro / Black	BRN = Marrom Marrón / Brown	BLU = Azul Azul / Blue	GRA = Cinza Gris / Gray	GRN = Verde Verde / Green	ORN = Laranja Naranja / Orange	PNK = Rosa Rosa / Pink	PPL = Violeta Violeta / Purple	RED = Vermelho Rojo / Red	TAN = Bege Beige / Tan	WHT = Branco Blanco / White	YEL = Amarelo Amarillo / Yellow	LT = Claro Claro / Light	DK = Escuro Oscuro / Dark
------------------------------	--------------------------------	---------------------------	----------------------------	------------------------------	-----------------------------------	---------------------------	-----------------------------------	------------------------------	---------------------------	--------------------------------	------------------------------------	-----------------------------	------------------------------

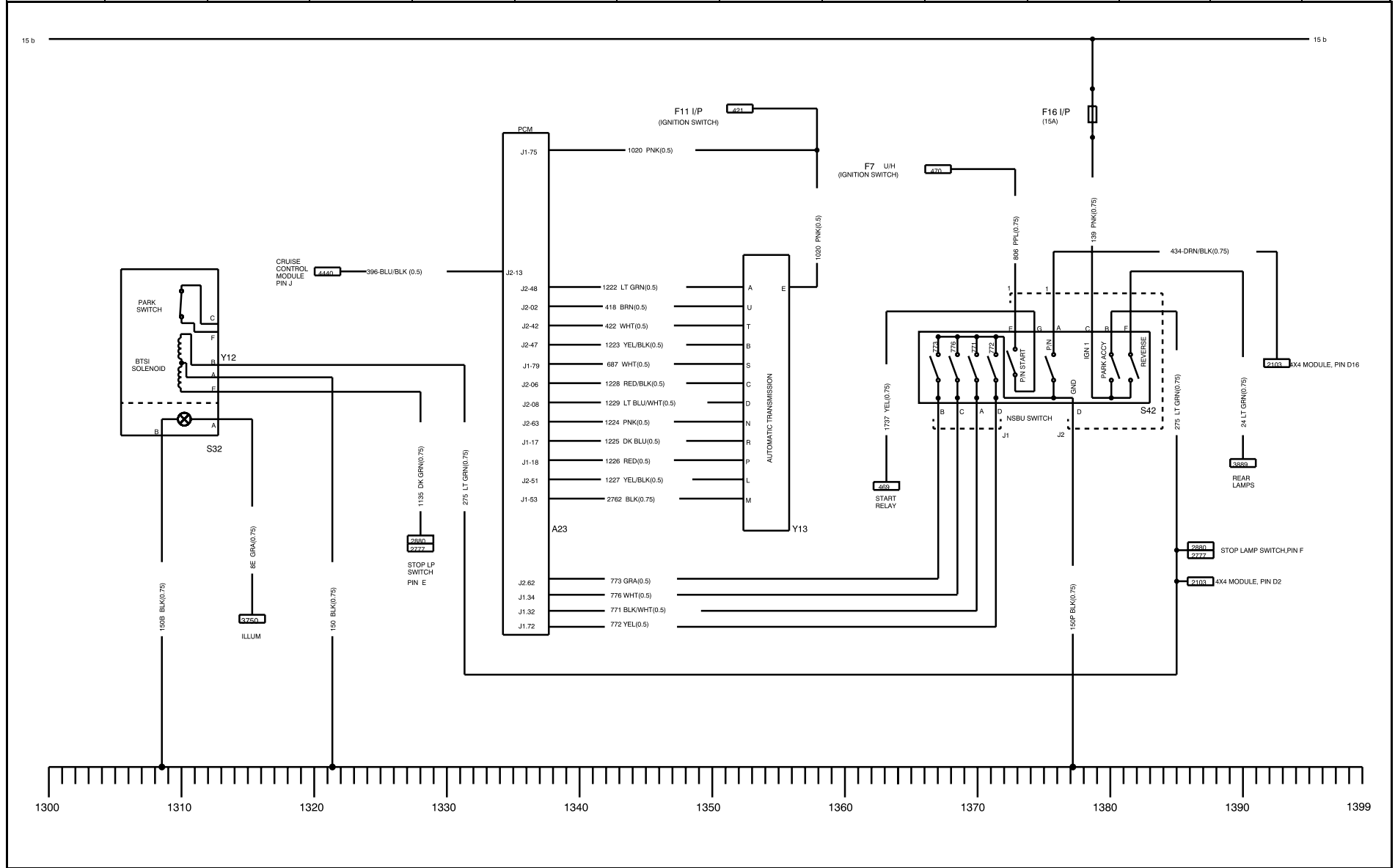

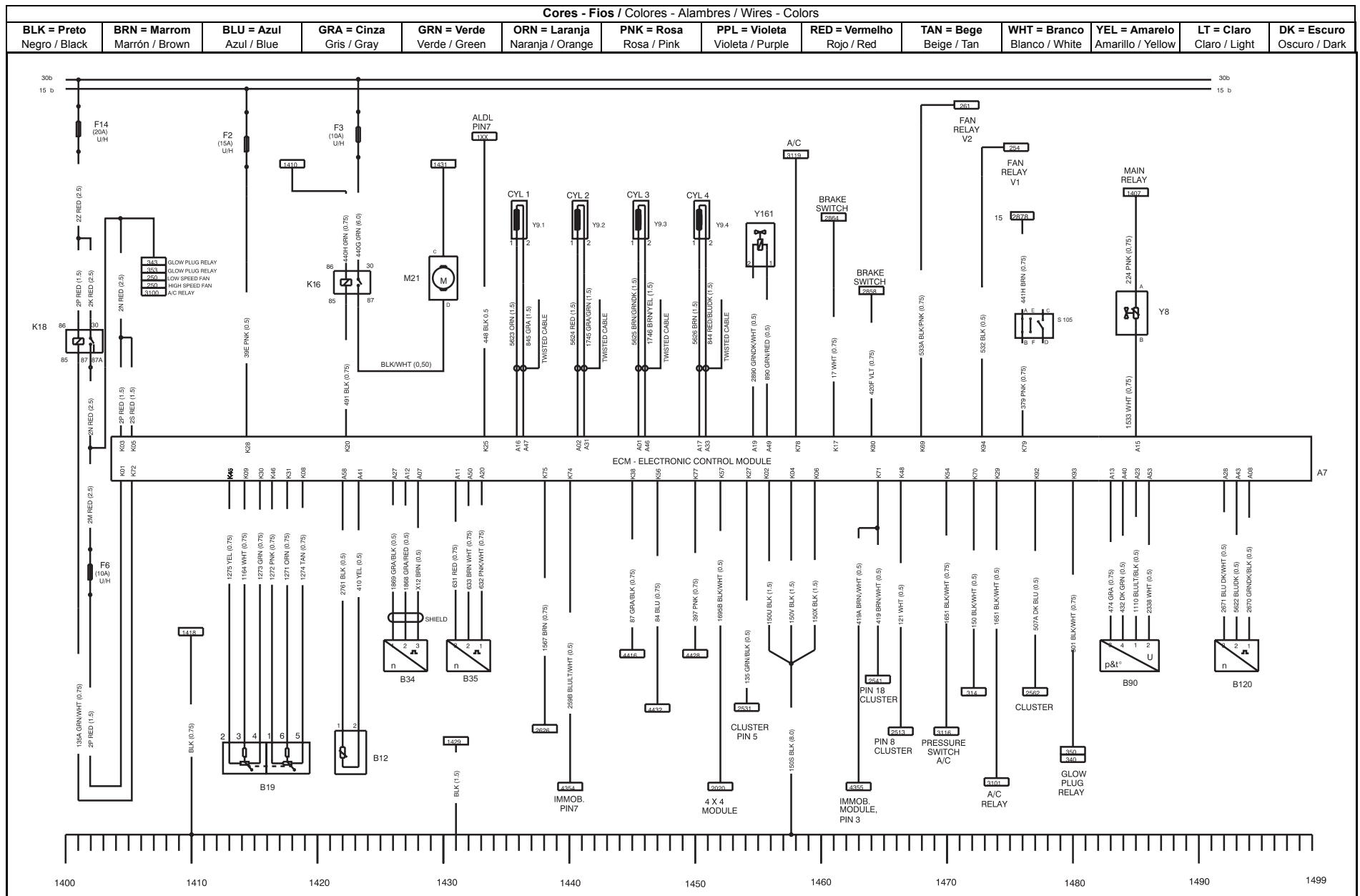

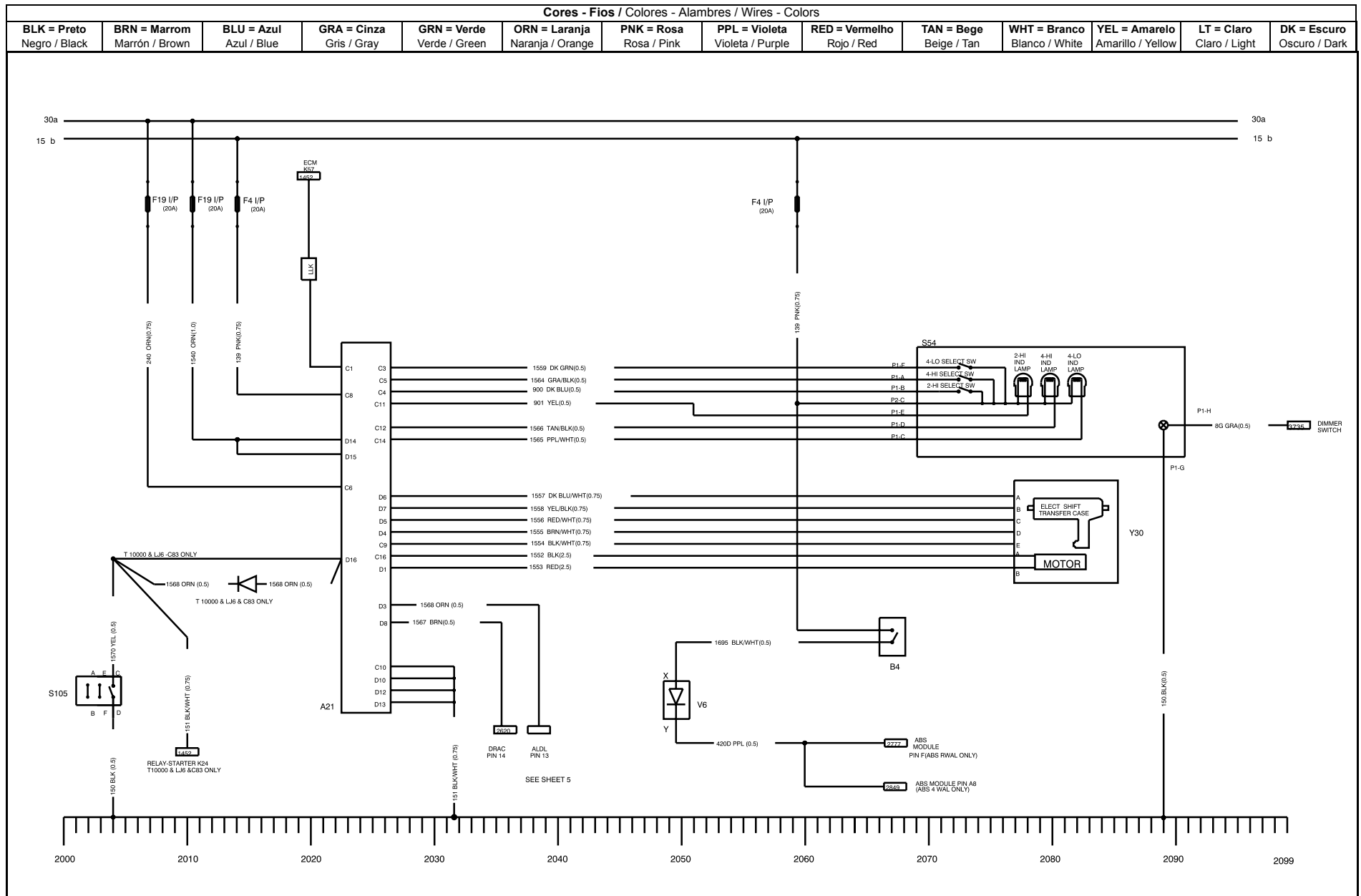

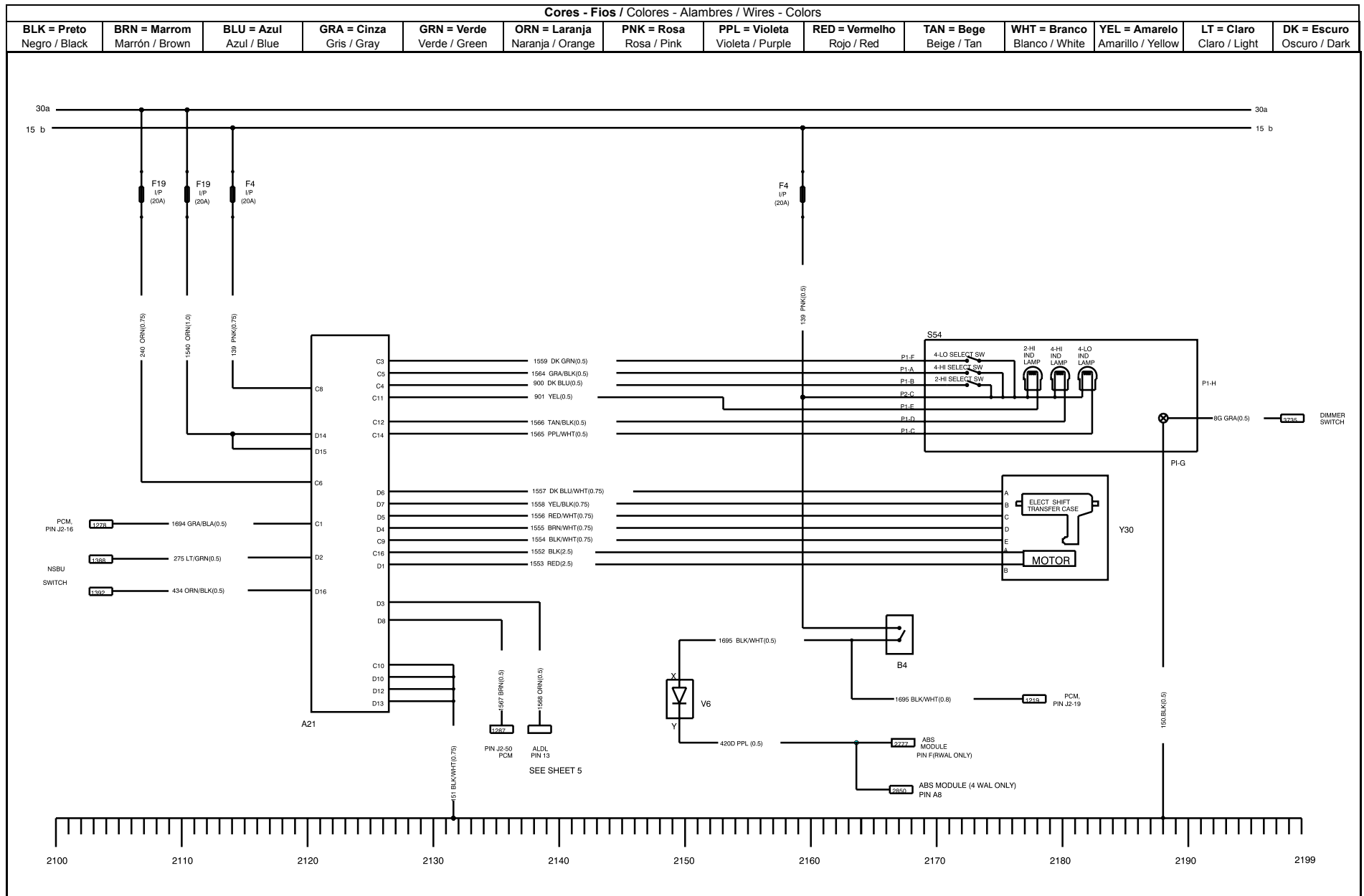

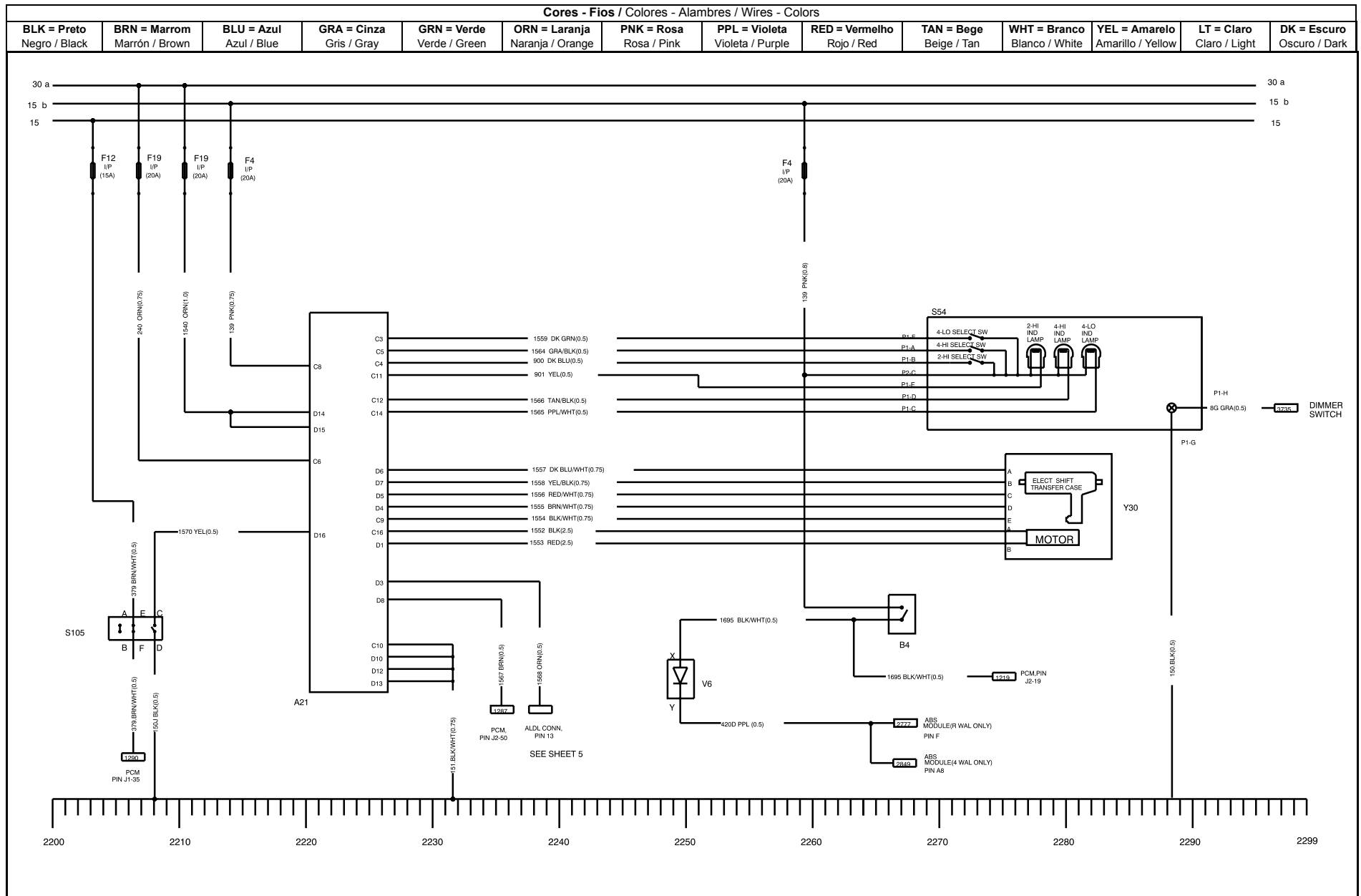

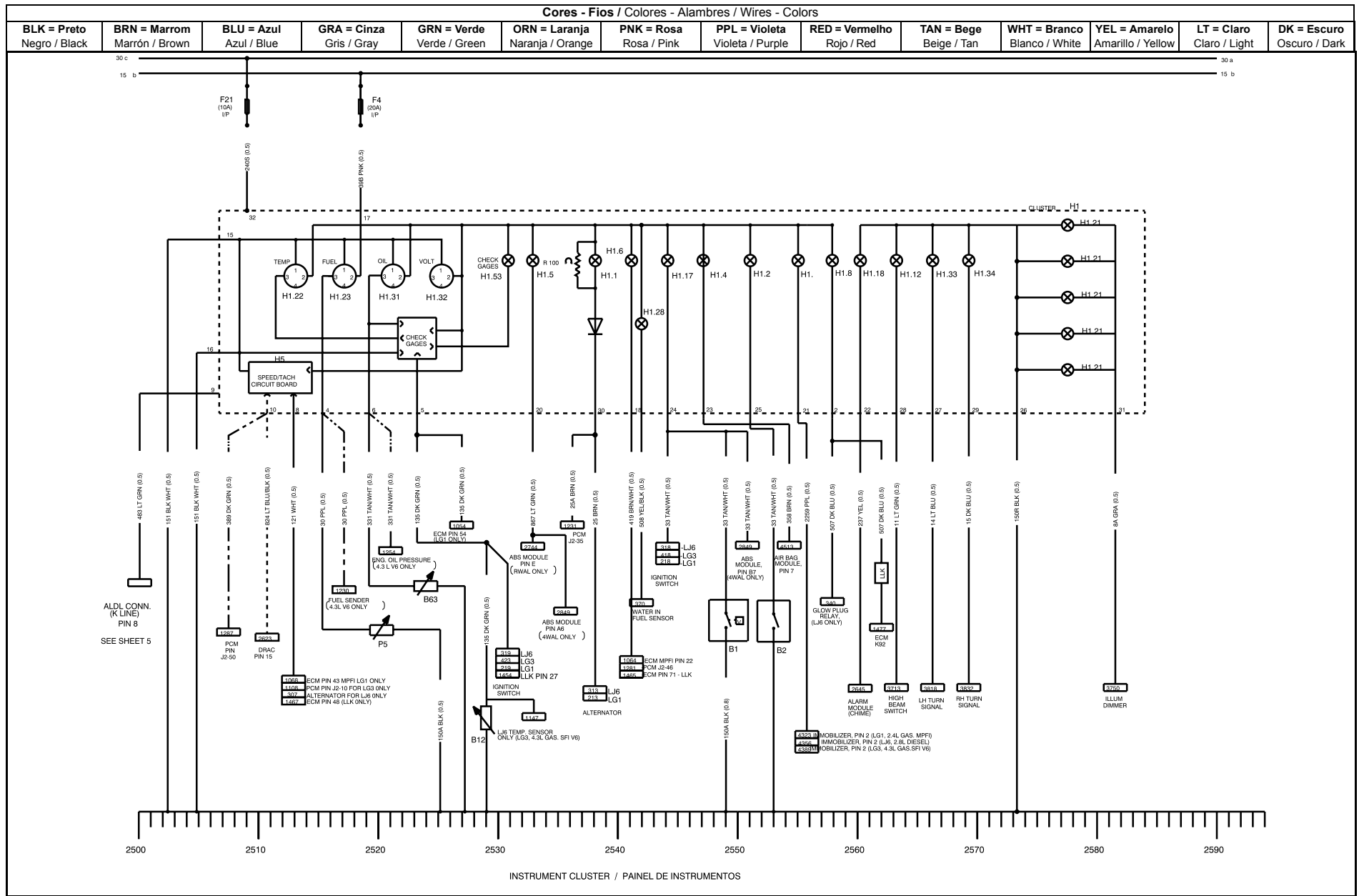

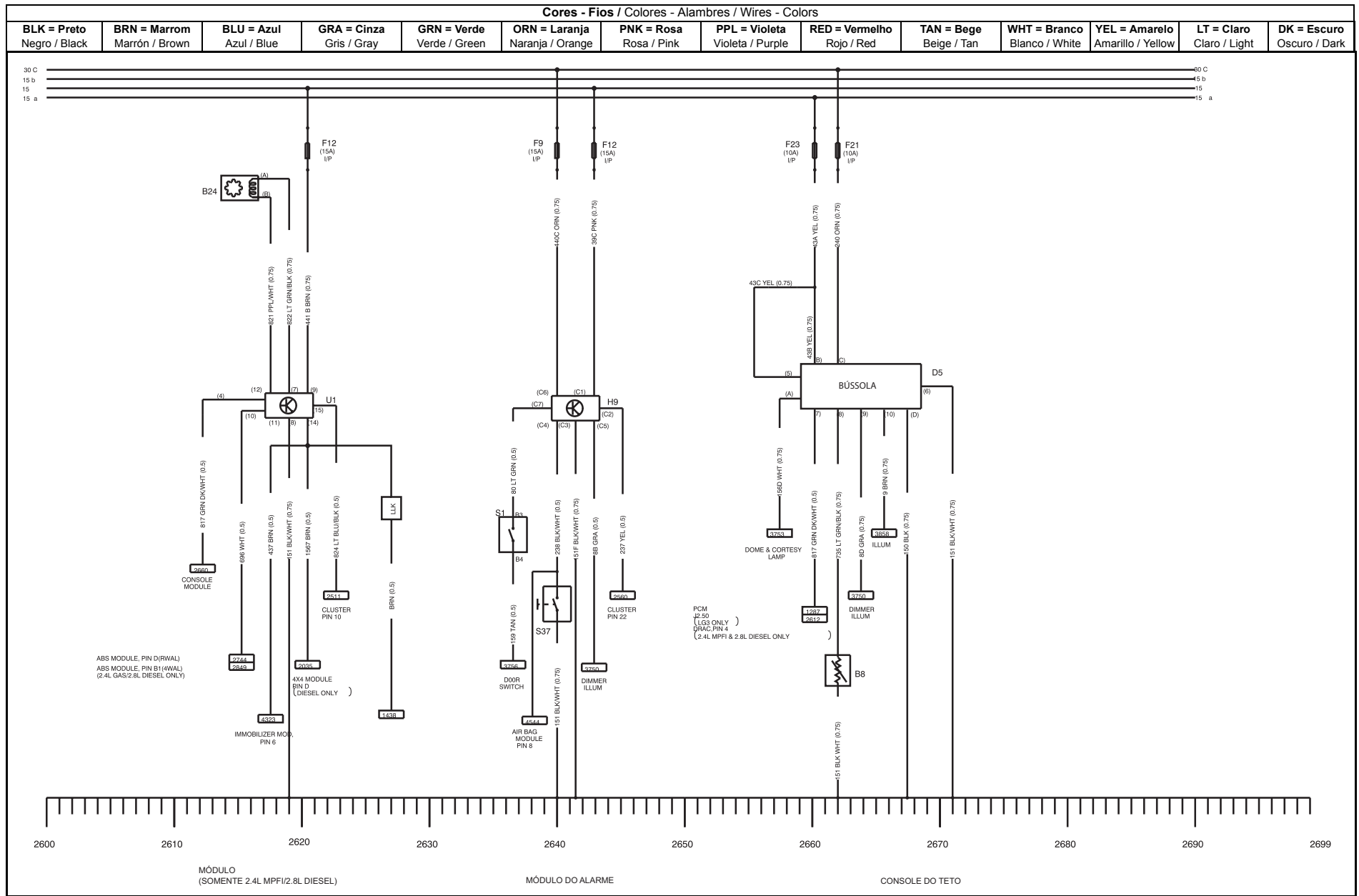

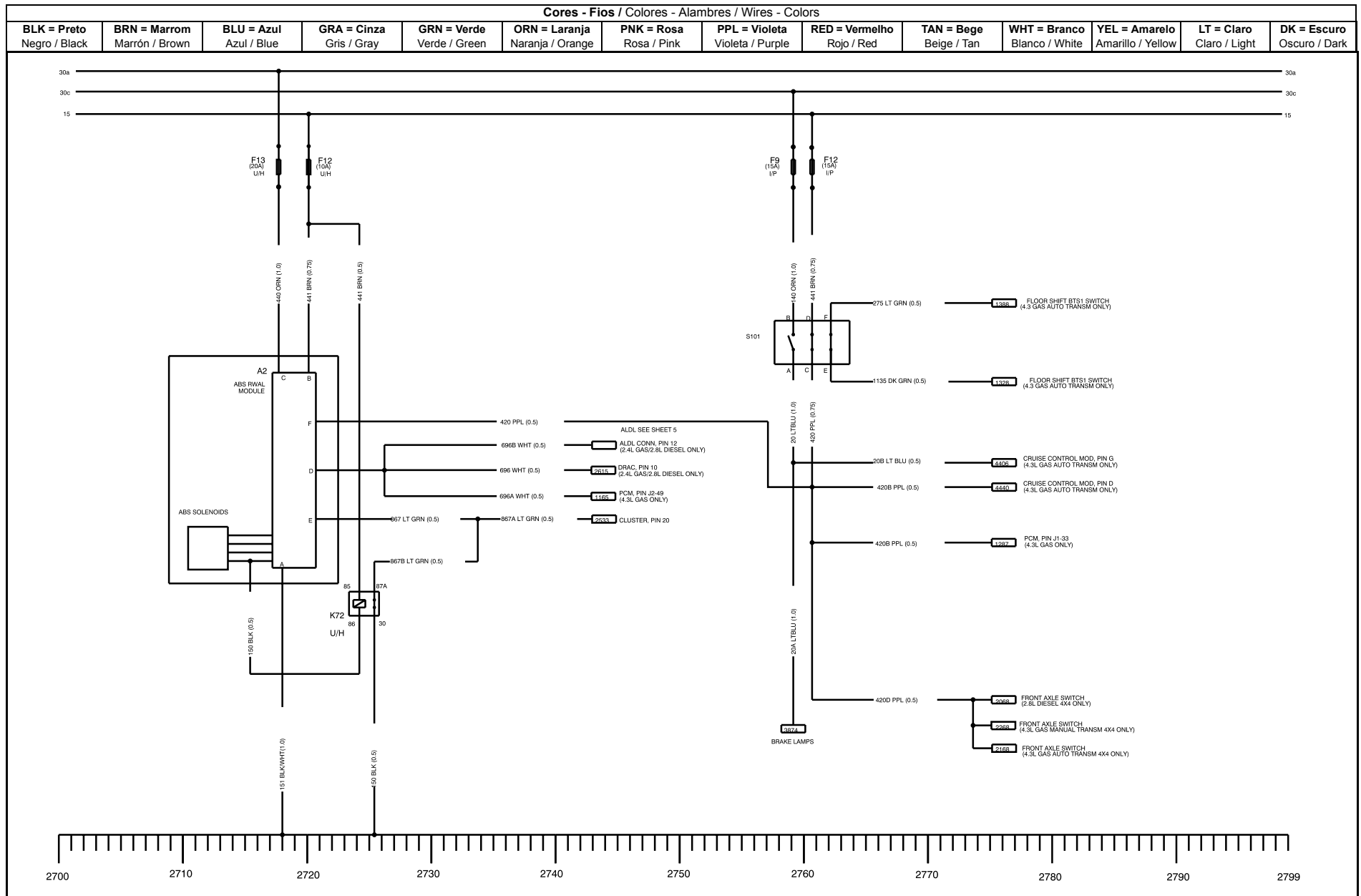

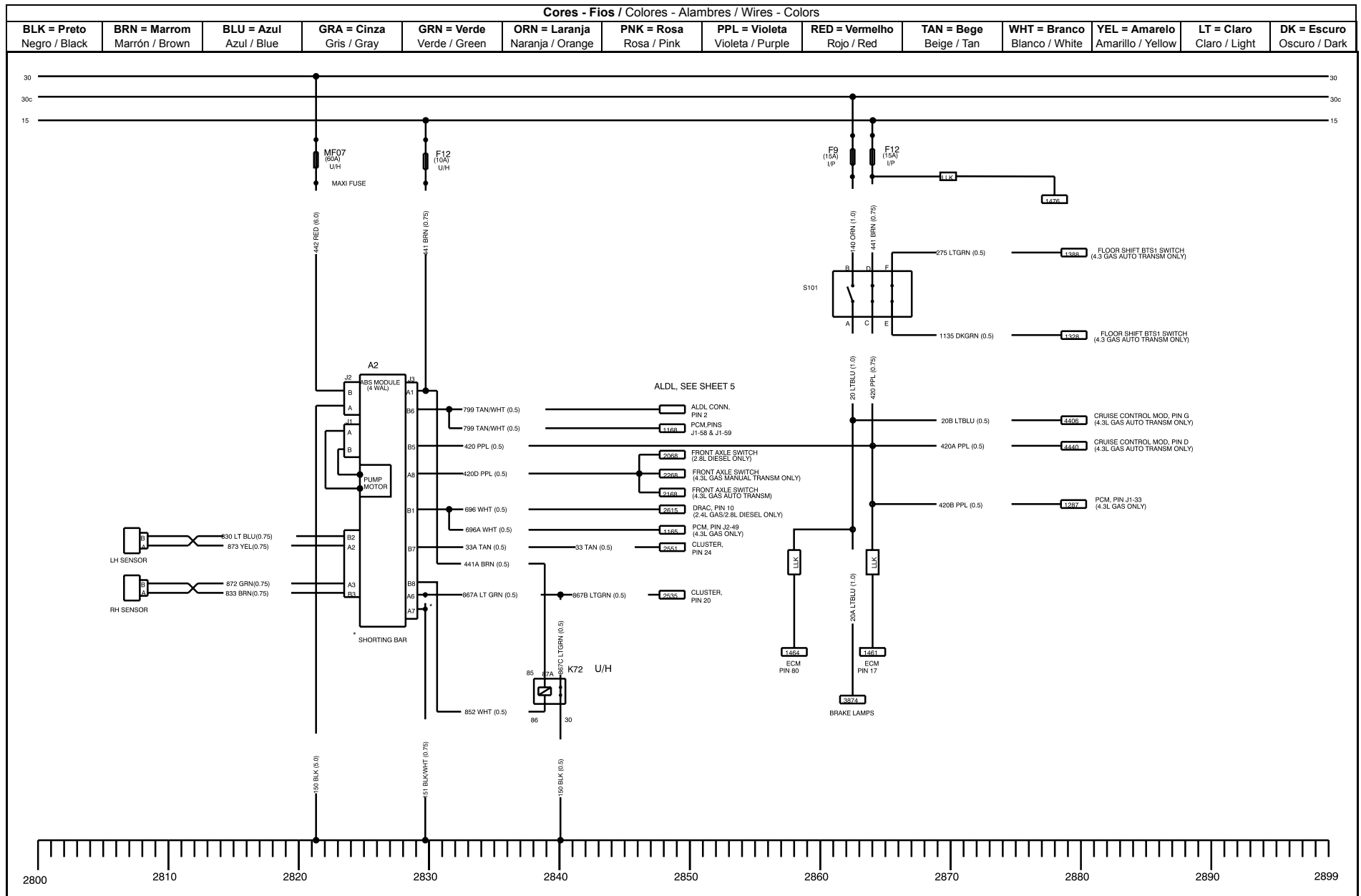

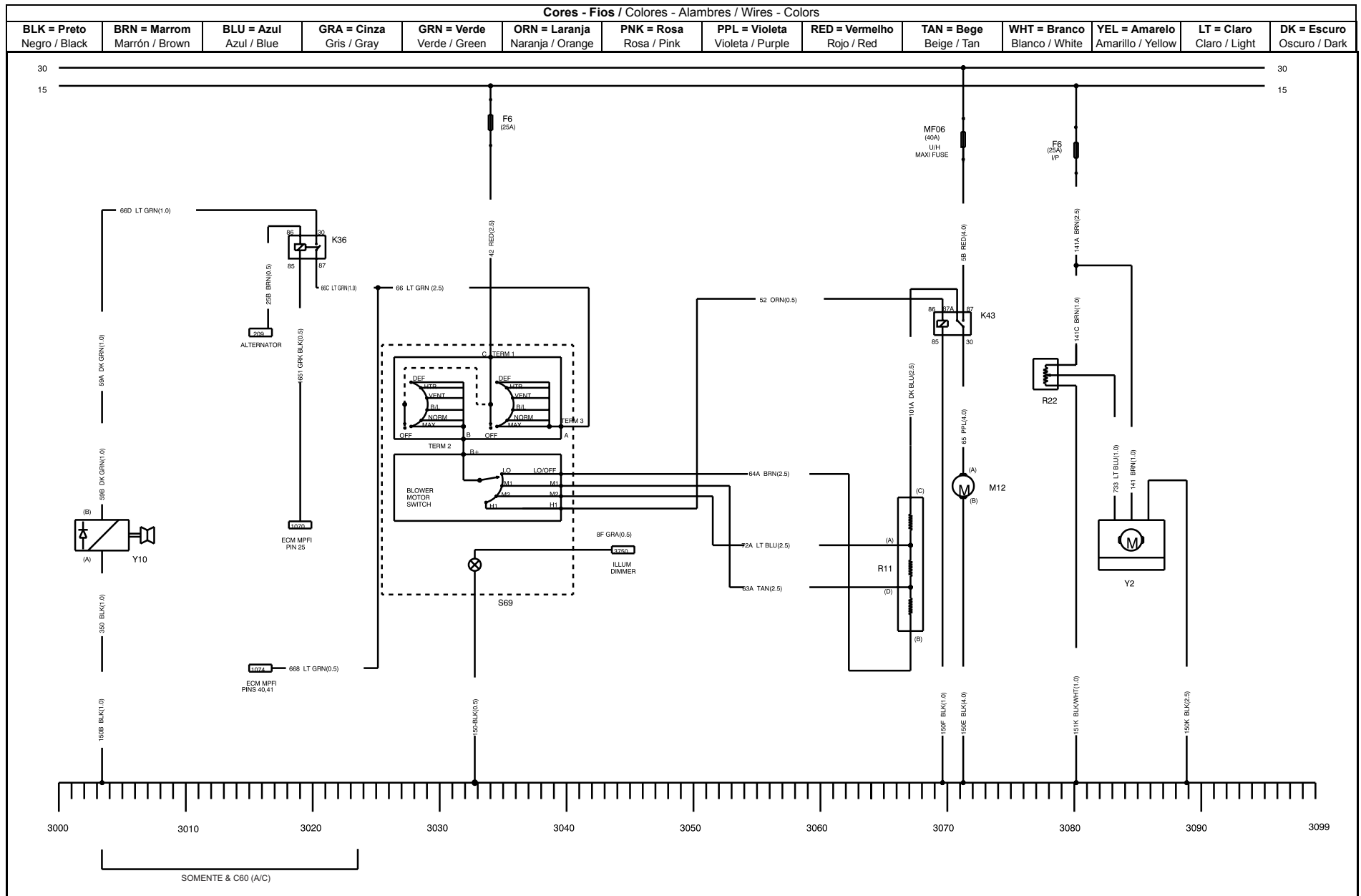

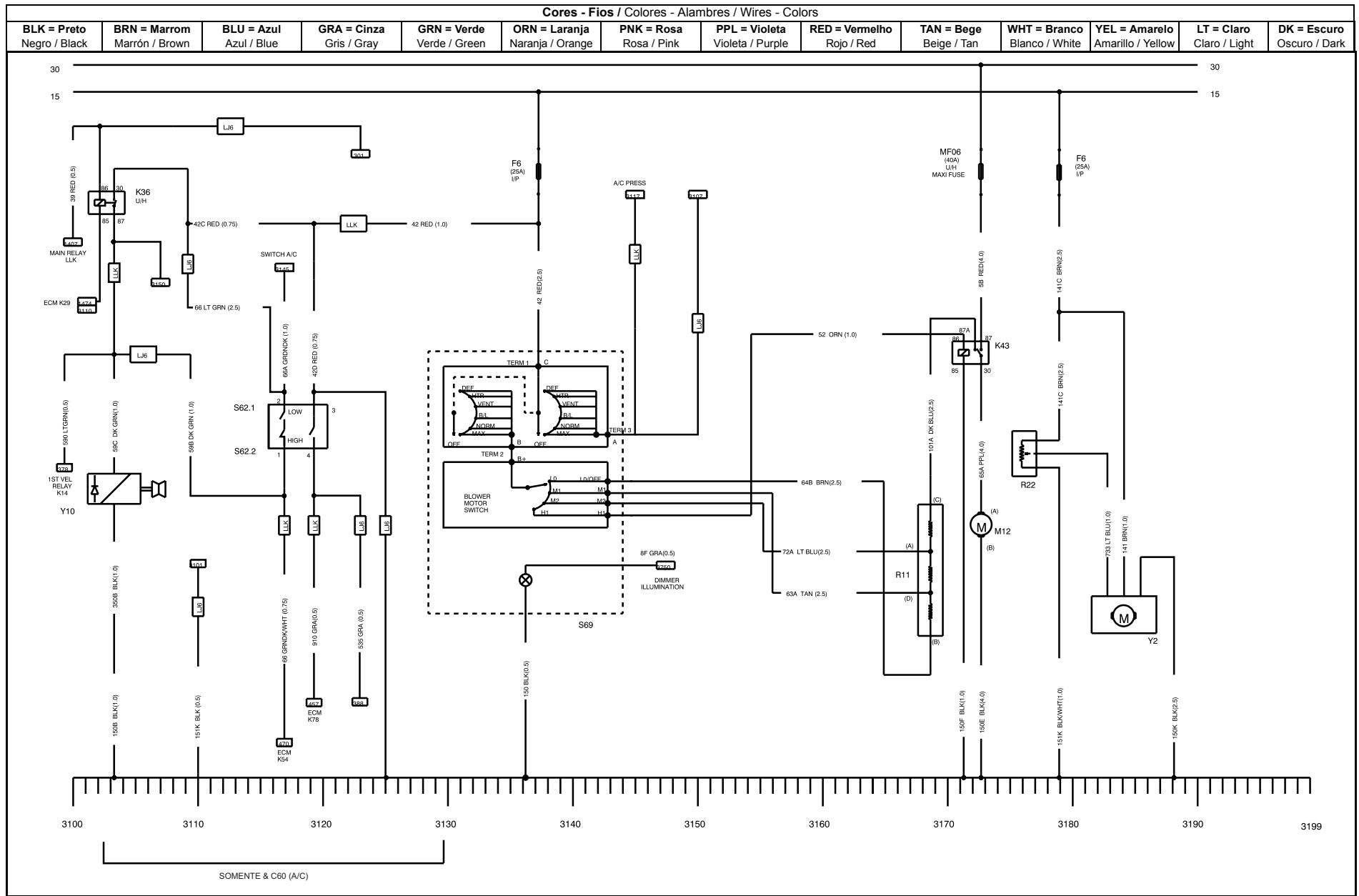

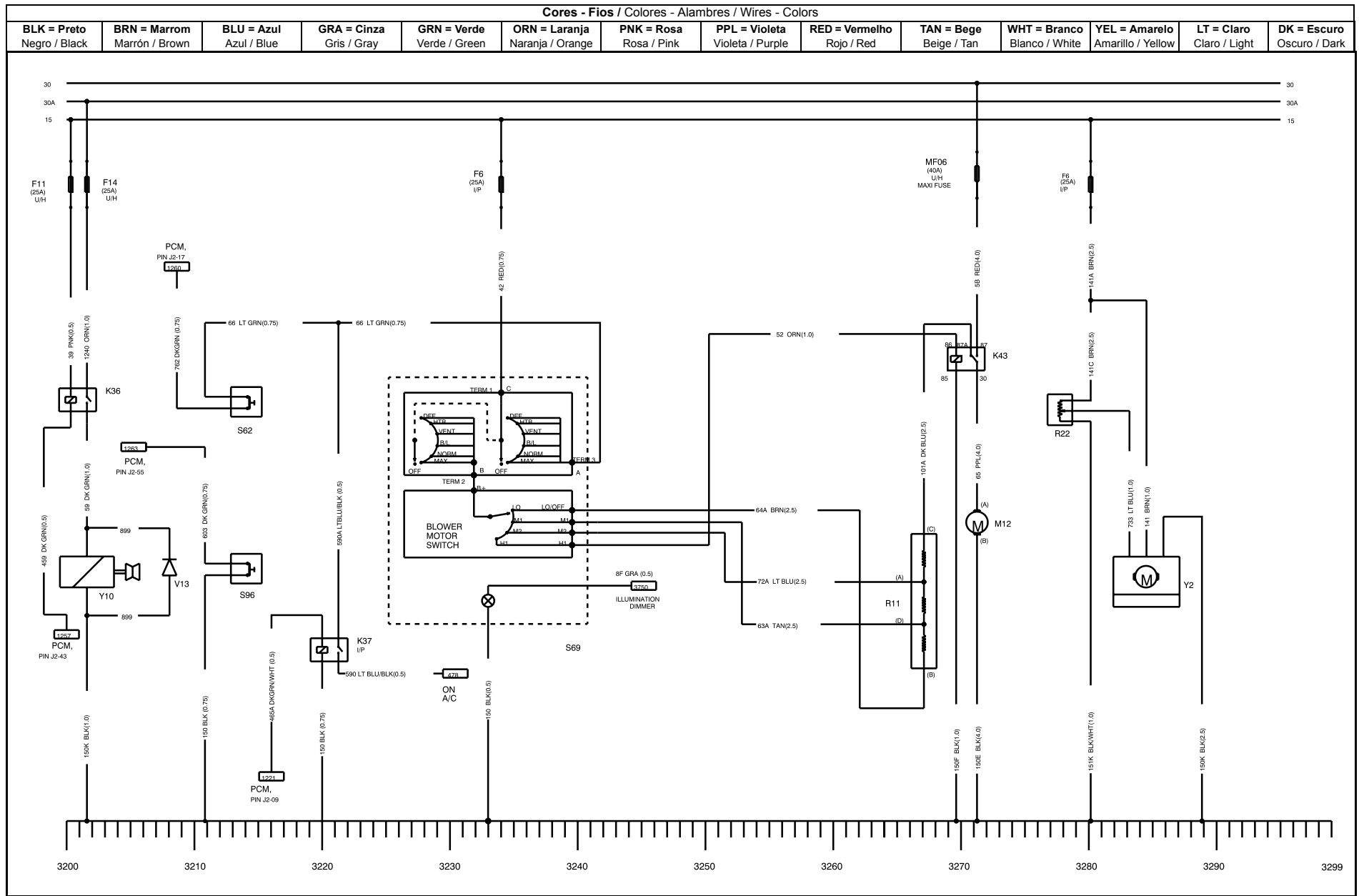

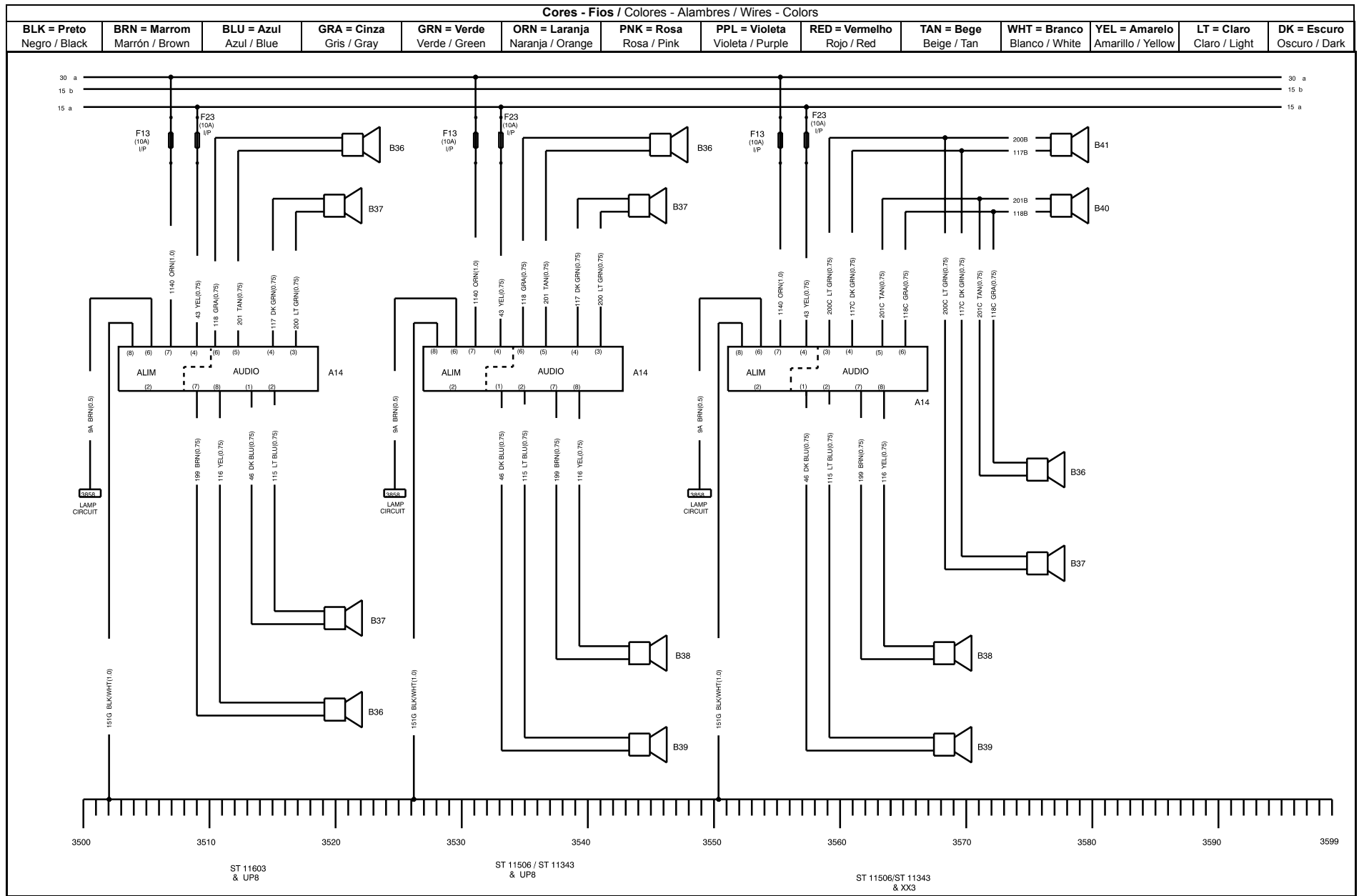

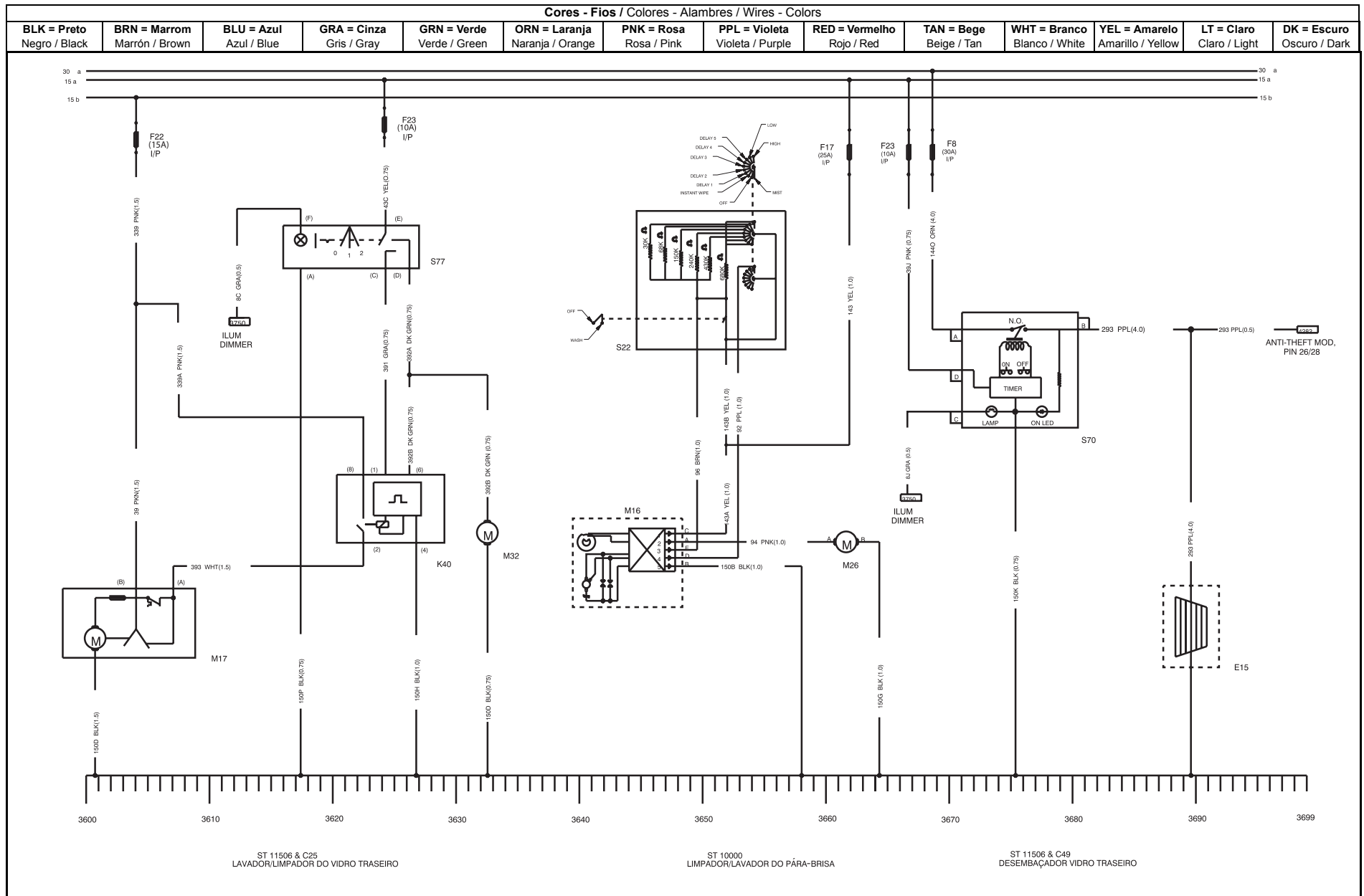

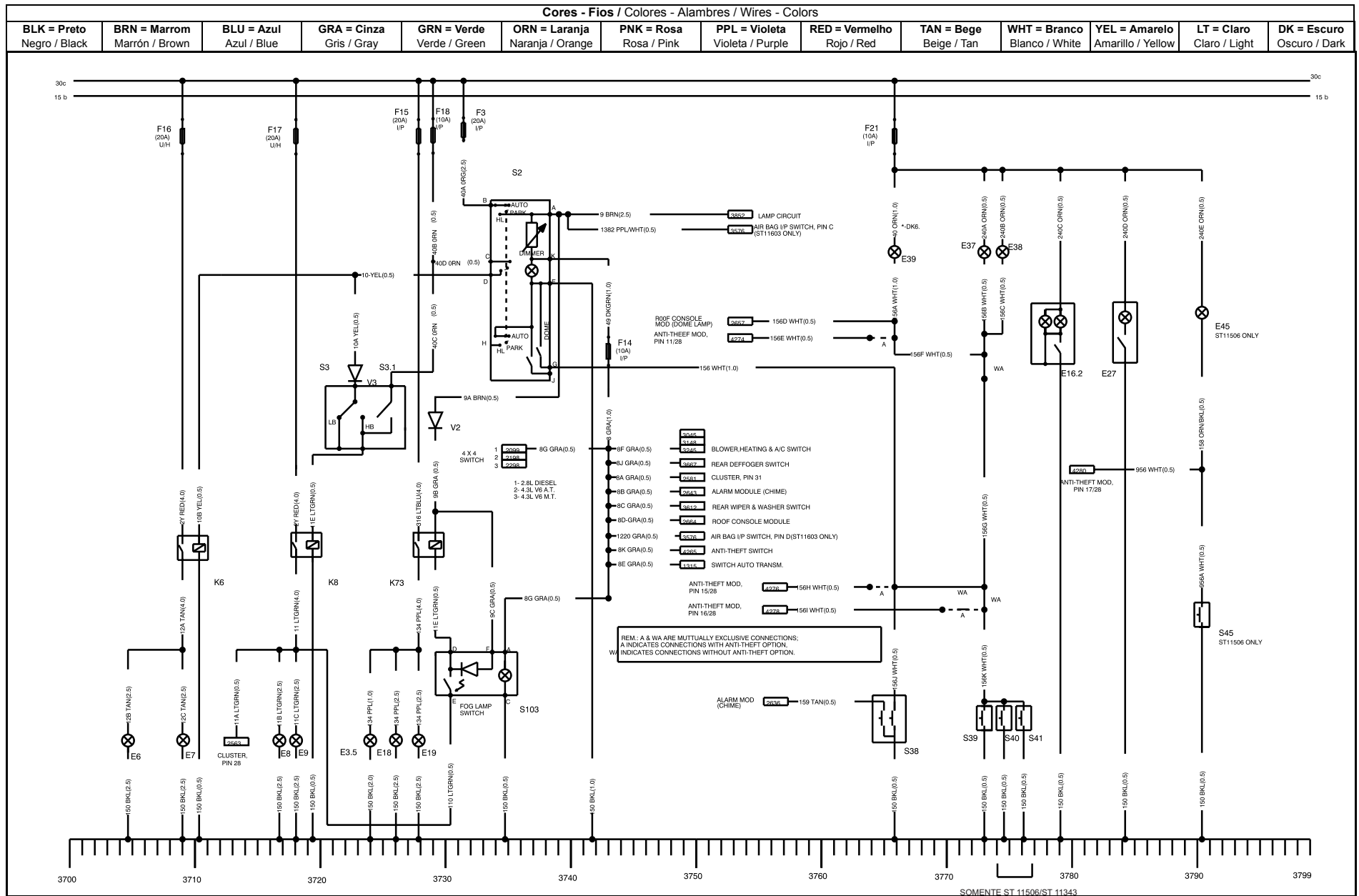

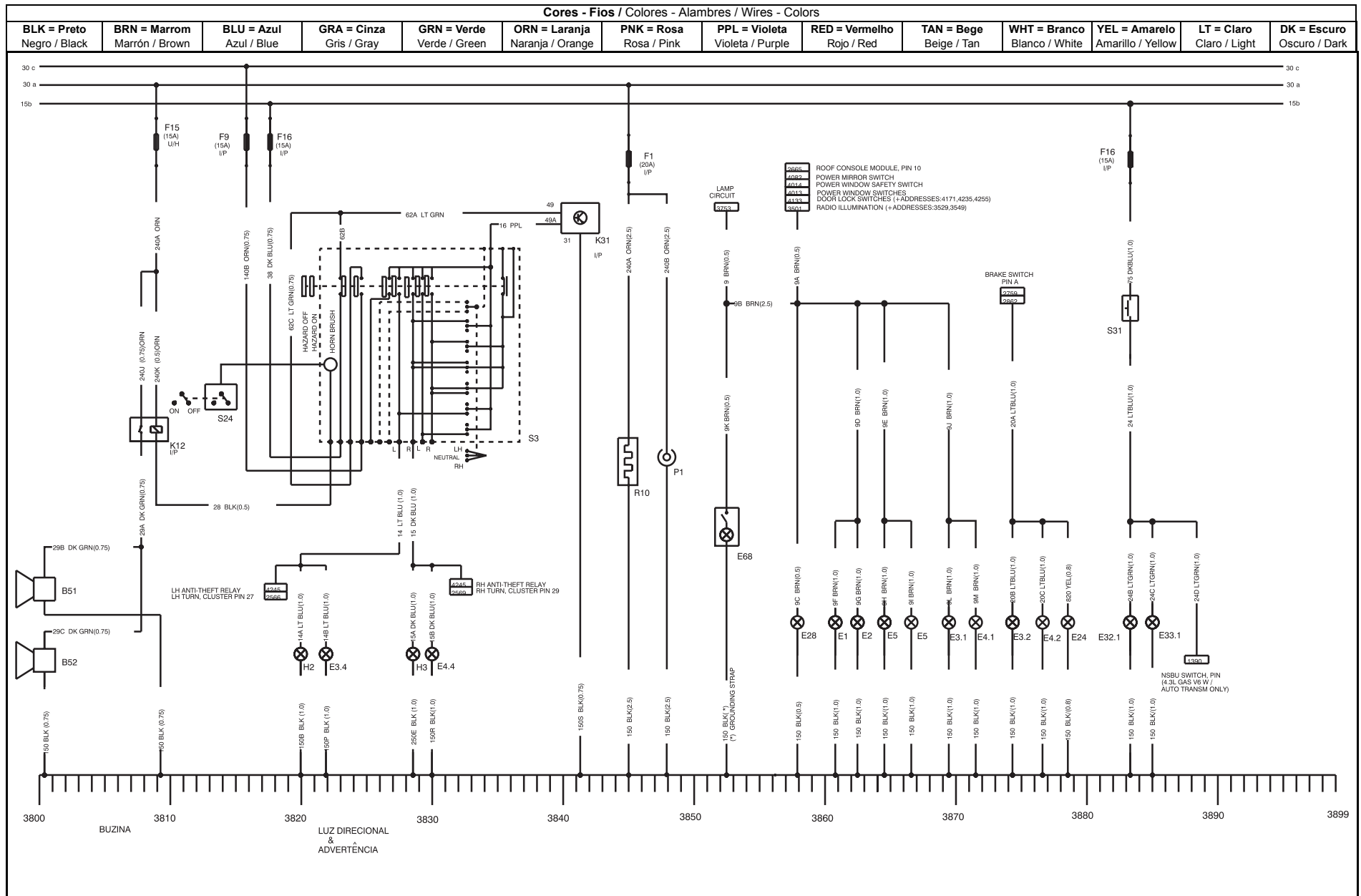

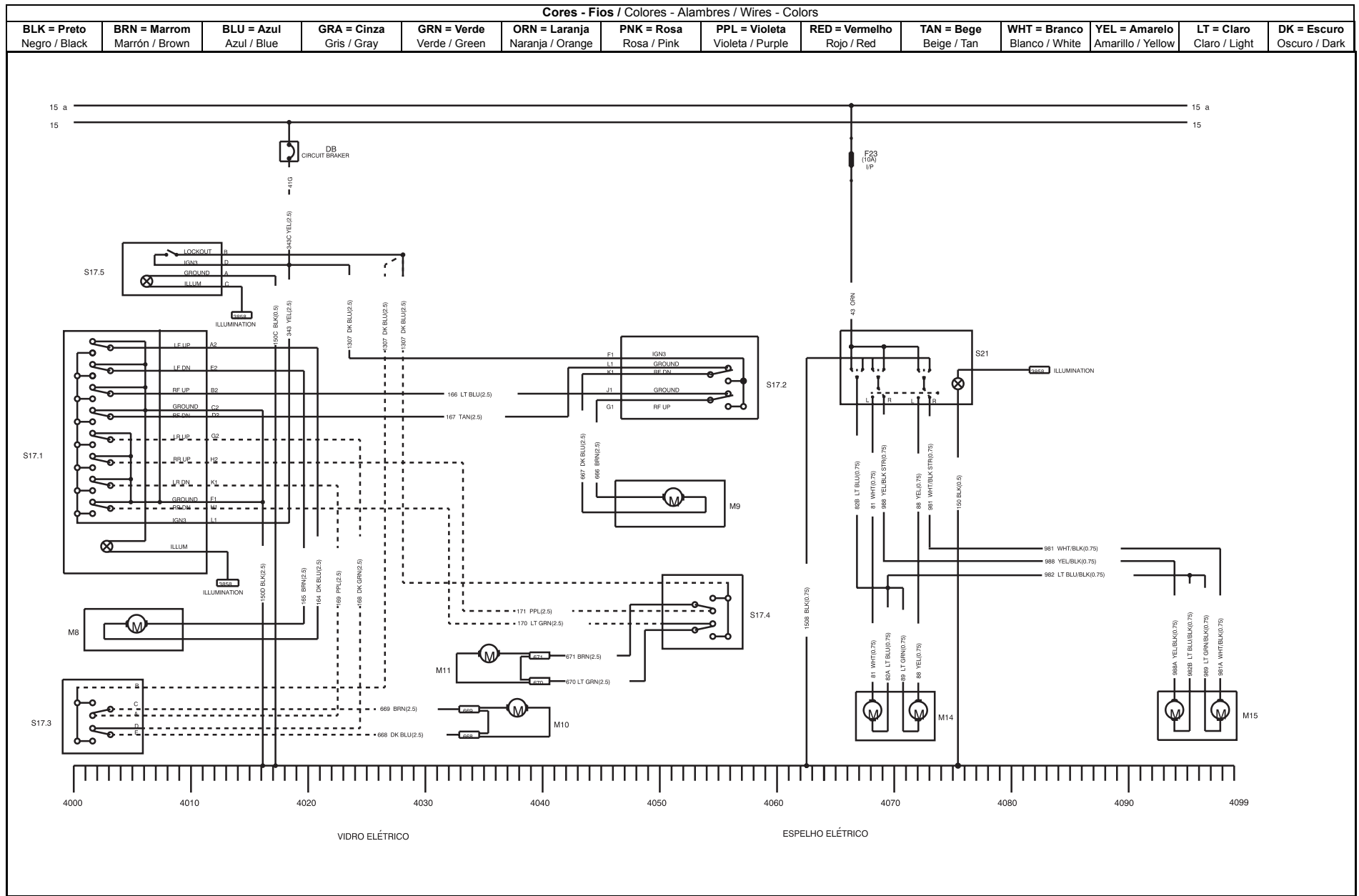

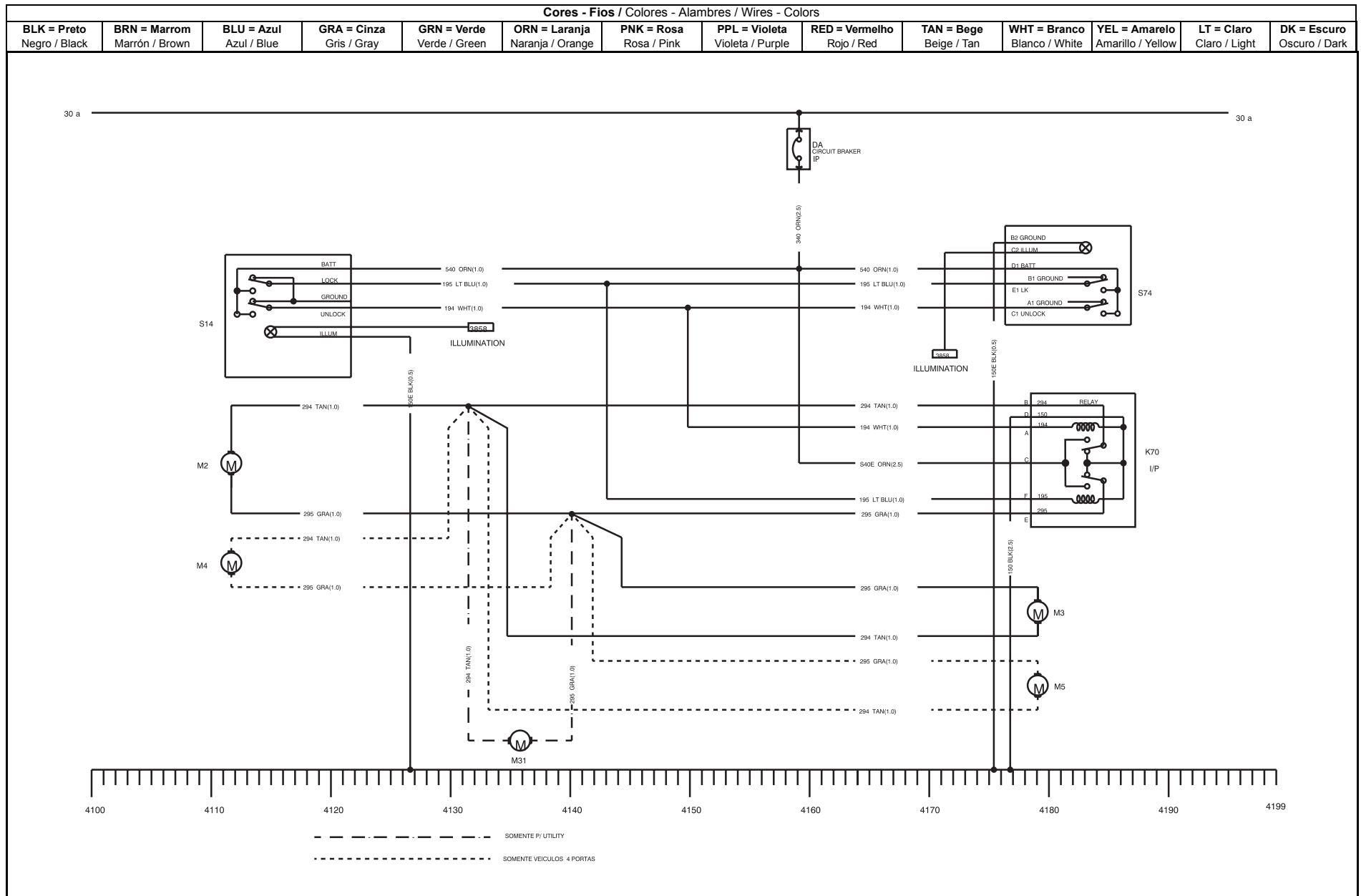

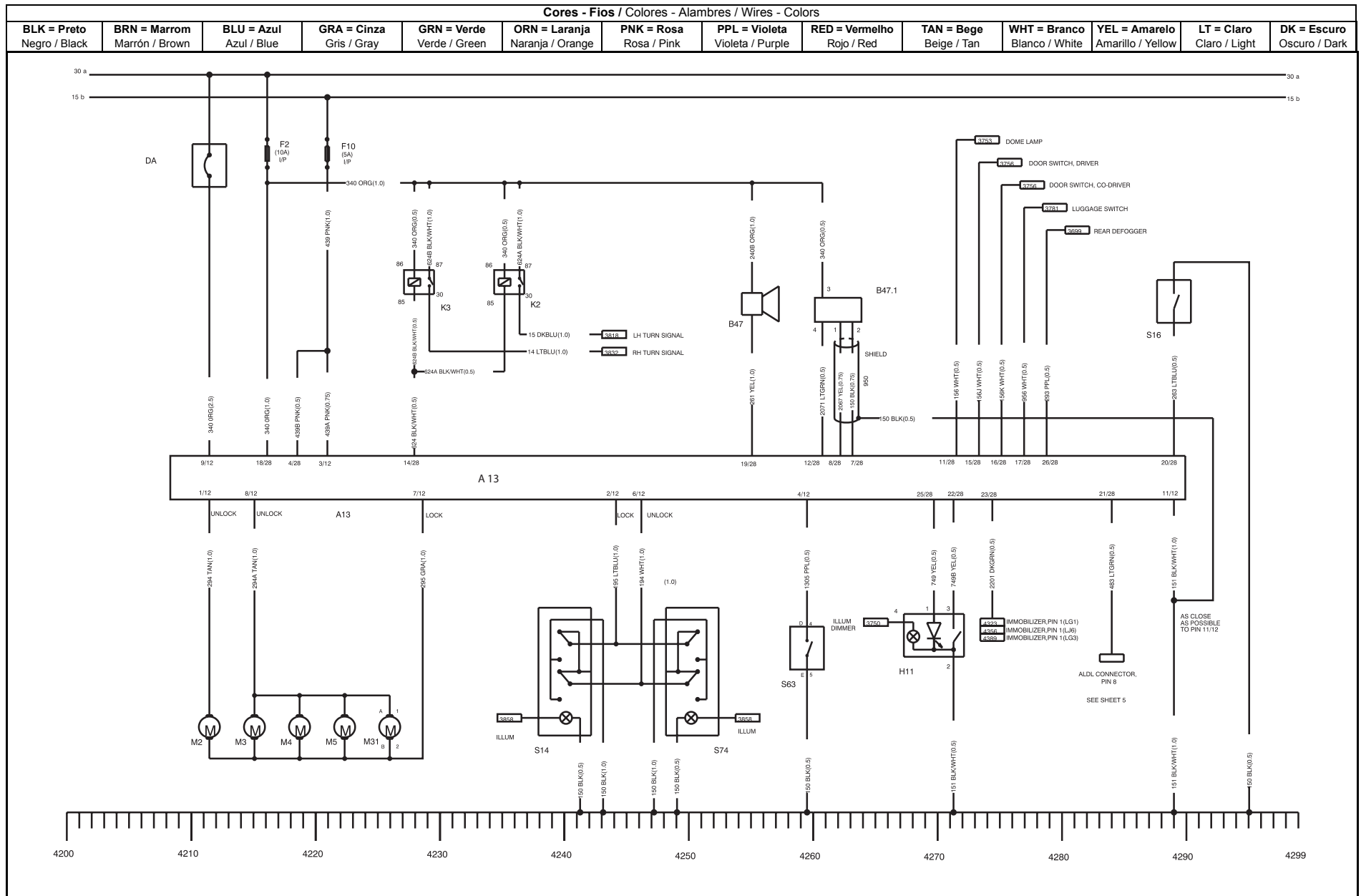

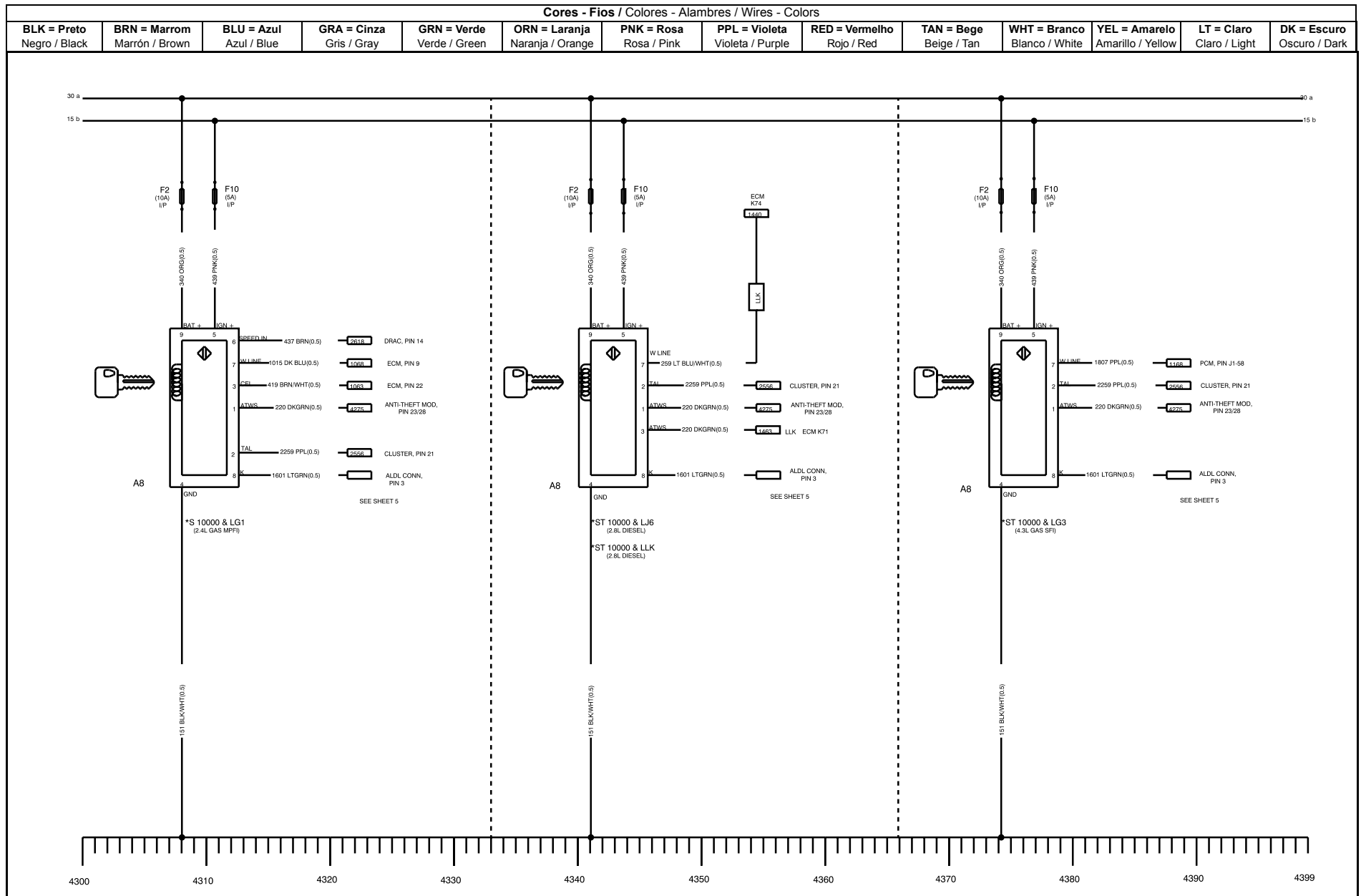

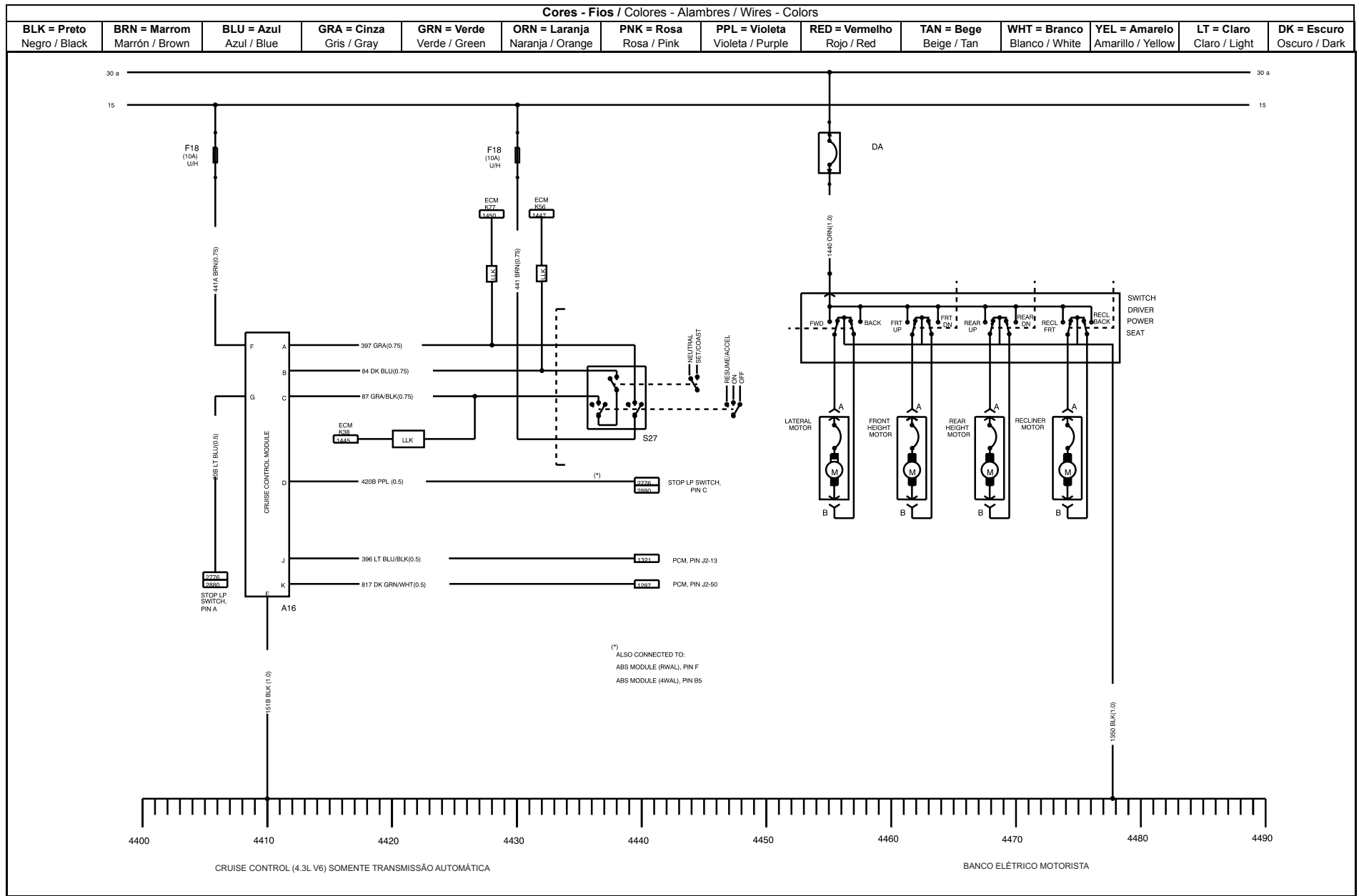

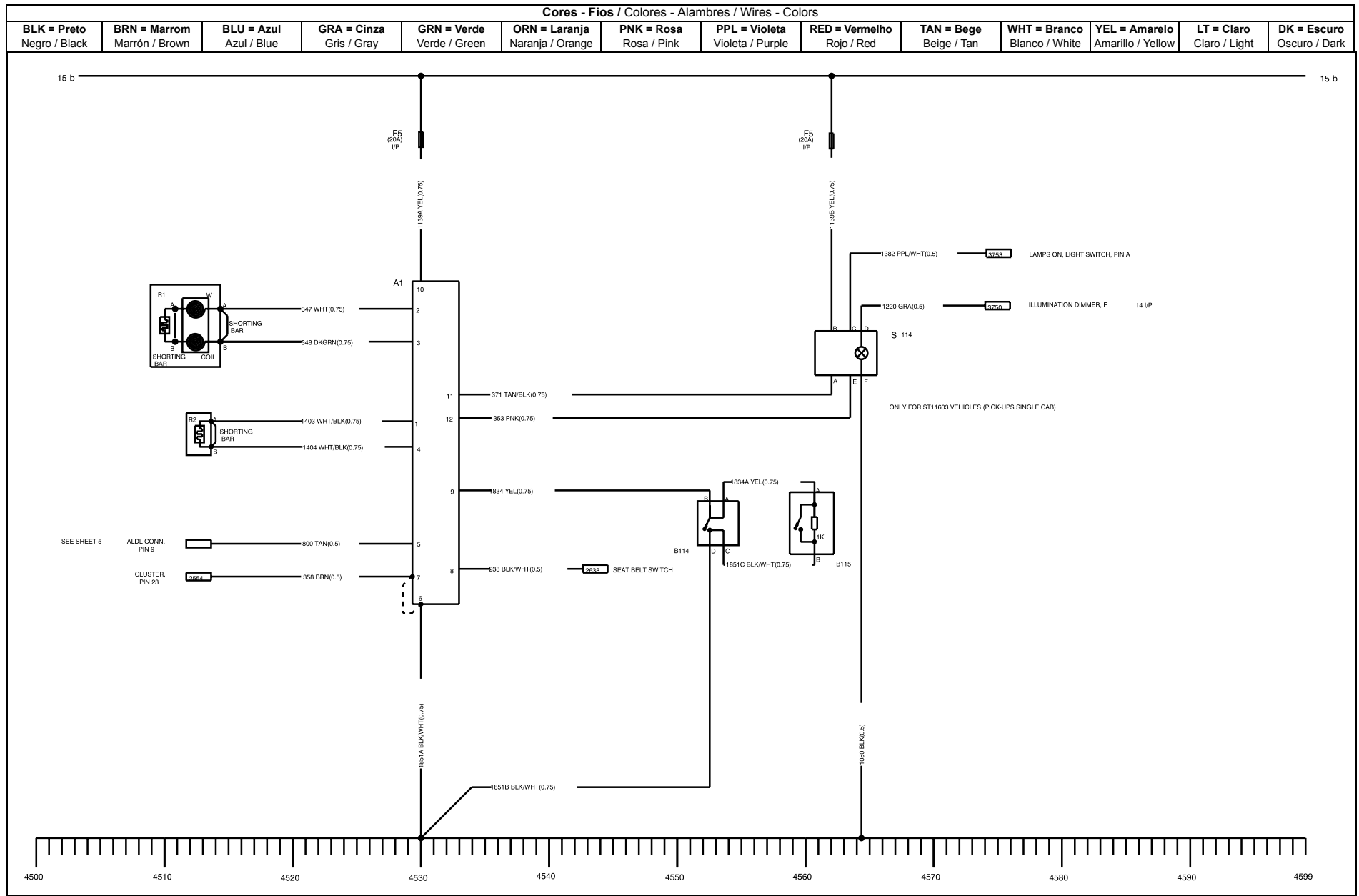

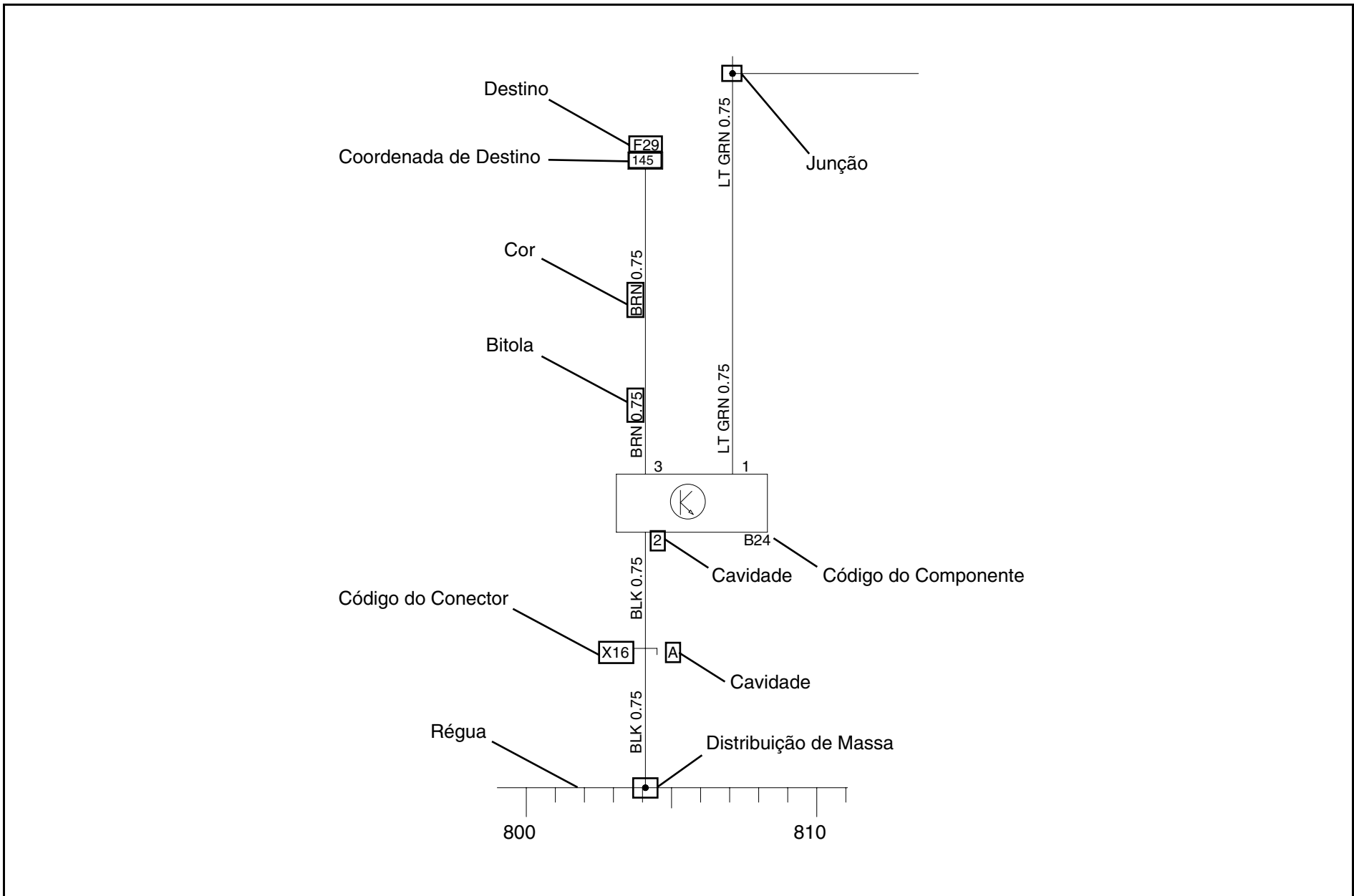

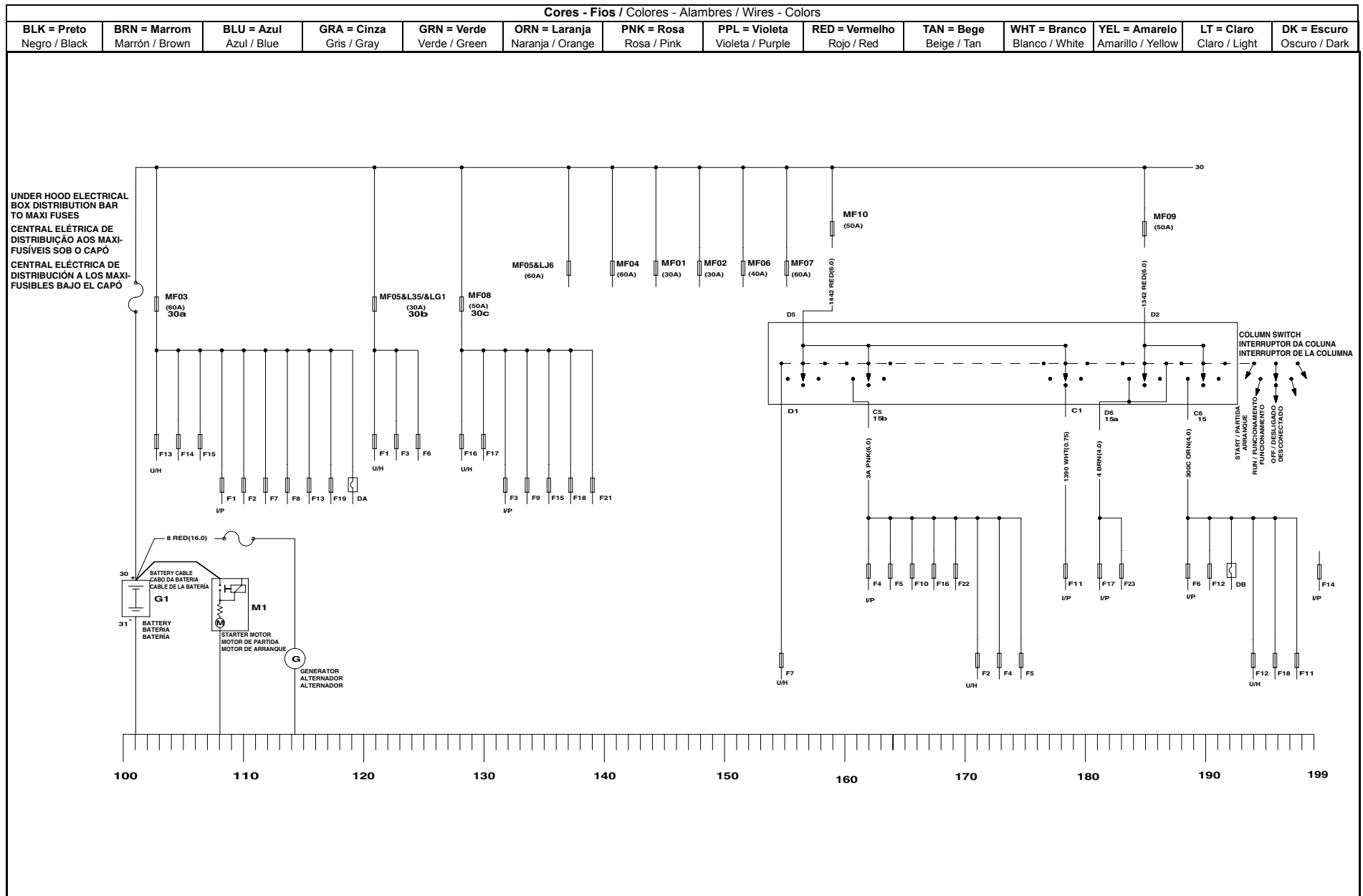

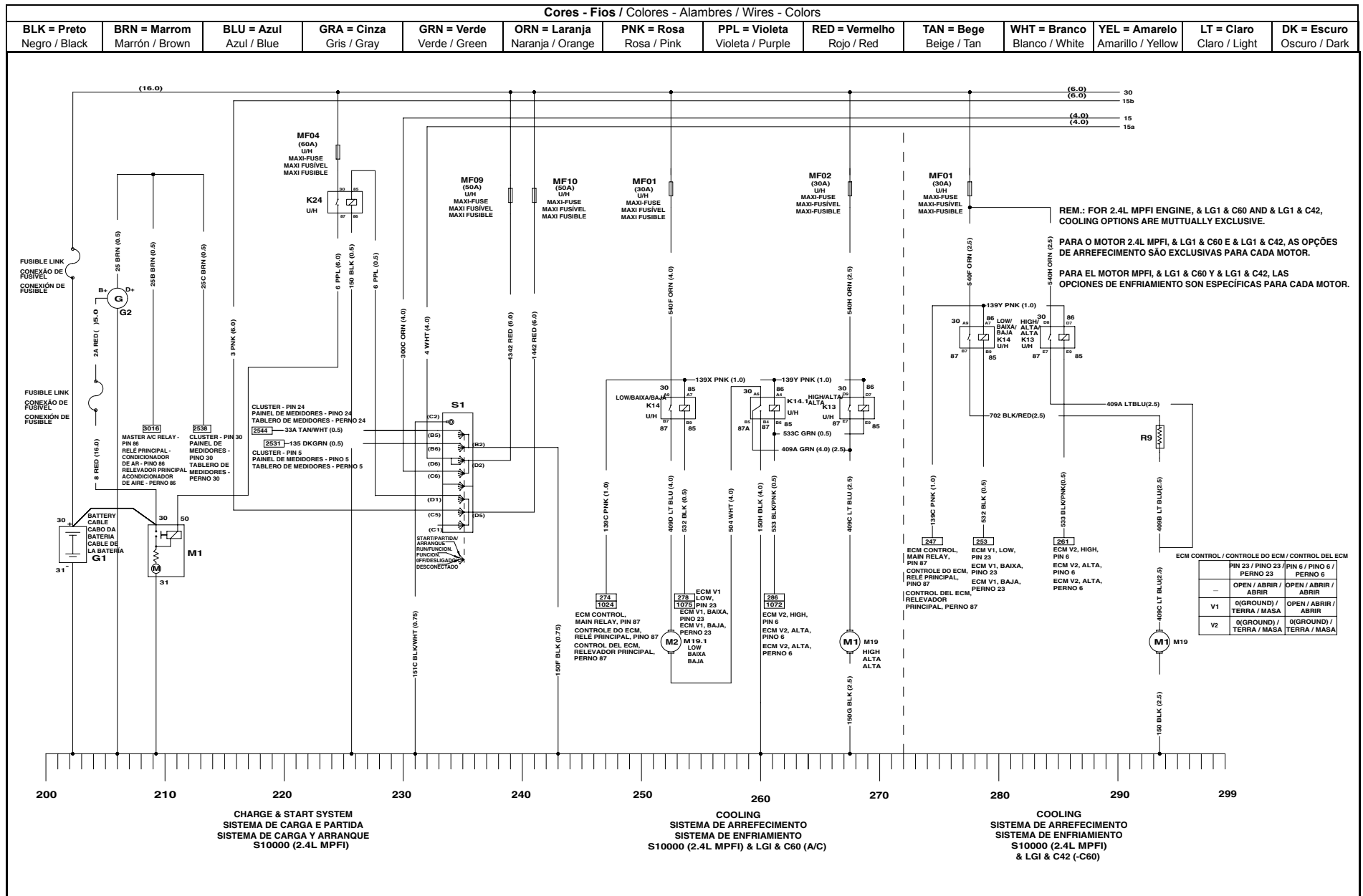

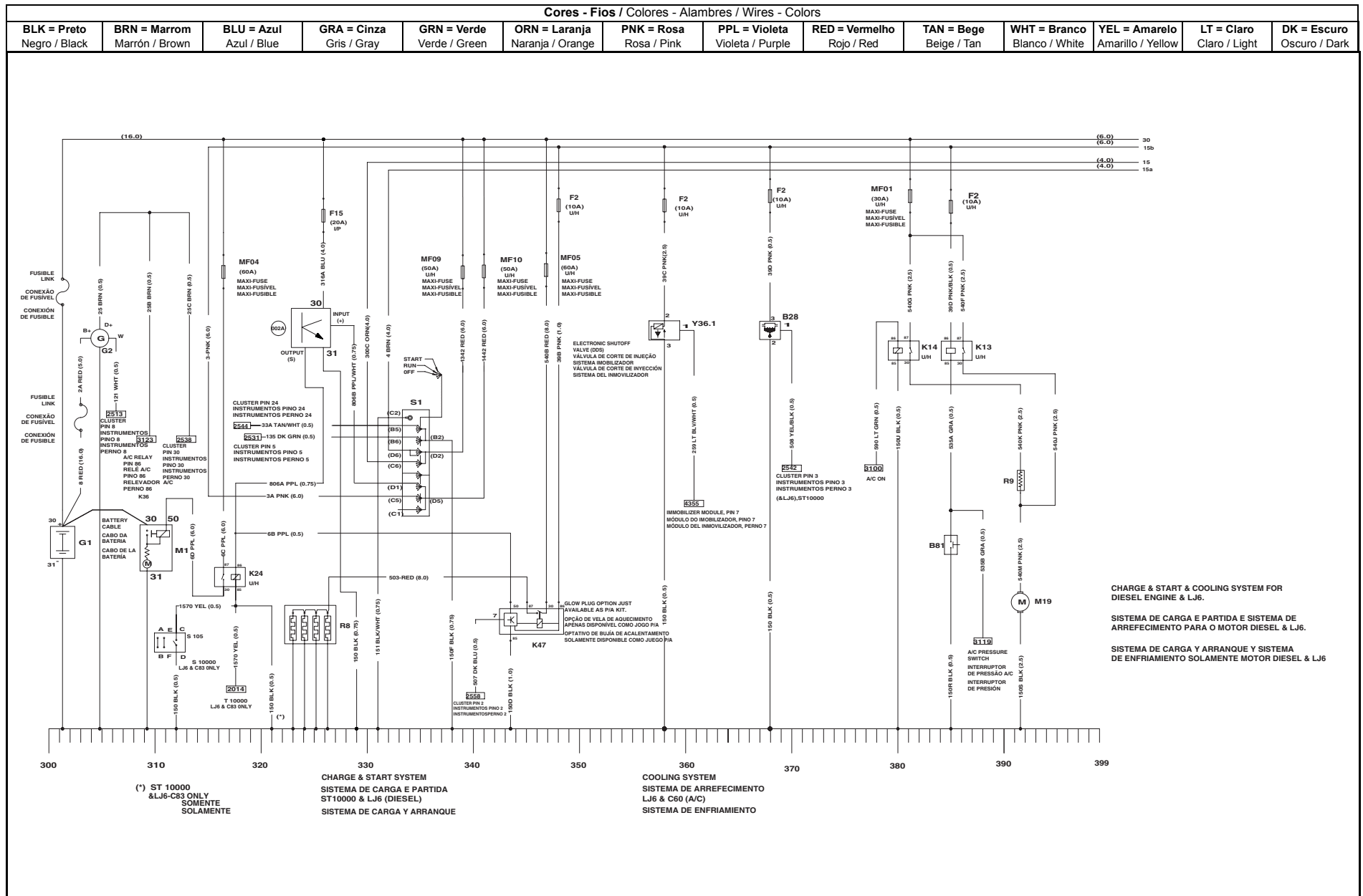

Cores - Fios / Colores - Alambres / Wires - Colors

BLK = Preto Negro / Black	BRN = Marrom Marrón / Brown	BLU = Azul Azul / Blue	GRA = Cinza Gris / Gray	GRN = Verde Verde / Green	ORN = Laranja Naranja / Orange	PNK = Rosa Rosa / Pink	PPL = Violeta Violeta / Purple	RED = Vermelho Rojo / Red	TAN = Bege Beige / Tan	WHT = Branco Blanco / White	YEL = Amarelo Amarillo / Yellow	LT = Claro Claro / Light	DK = Escuro Oscuro / Dark
------------------------------	--------------------------------	---------------------------	----------------------------	------------------------------	-----------------------------------	---------------------------	-----------------------------------	------------------------------	---------------------------	--------------------------------	------------------------------------	-----------------------------	------------------------------

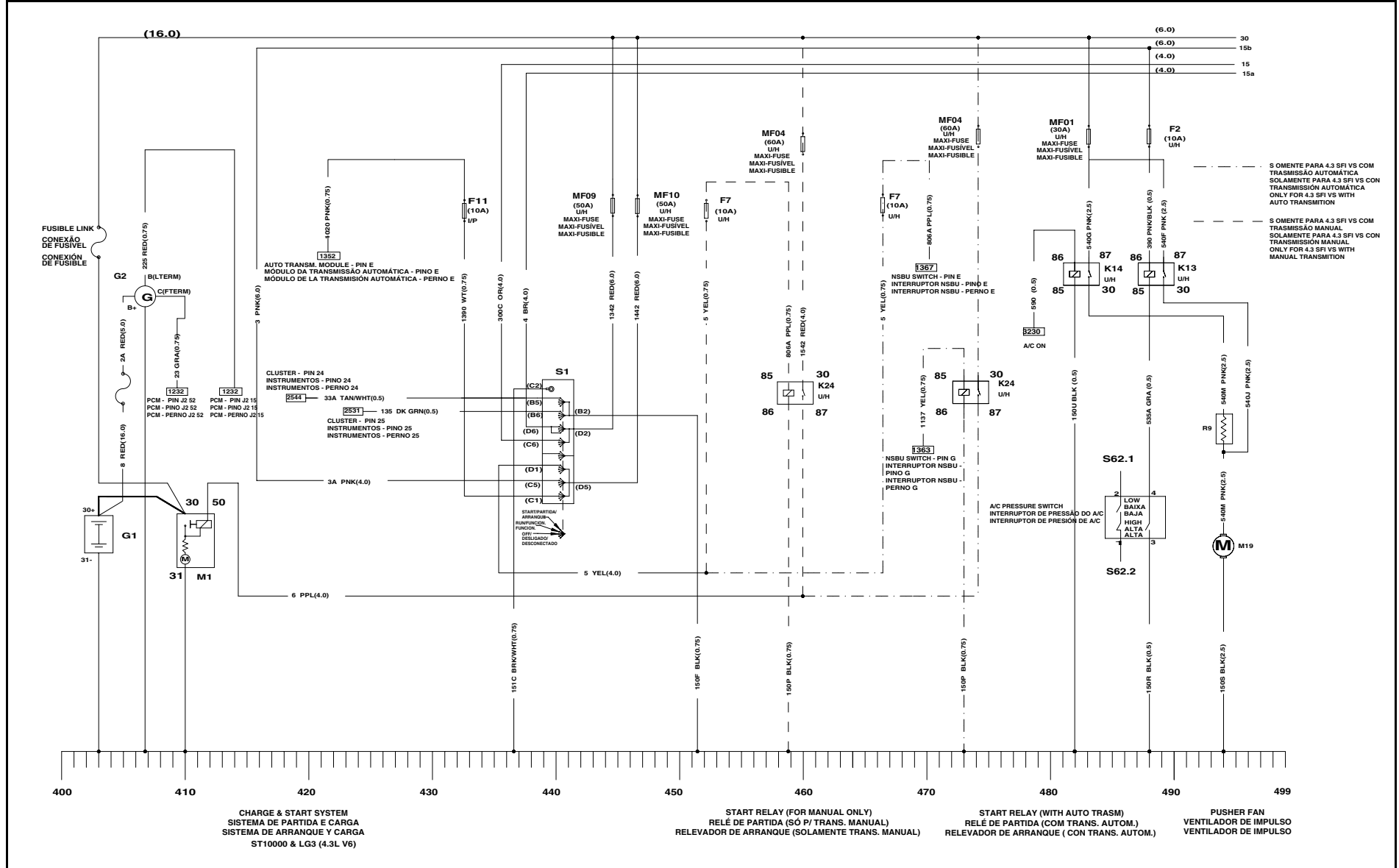

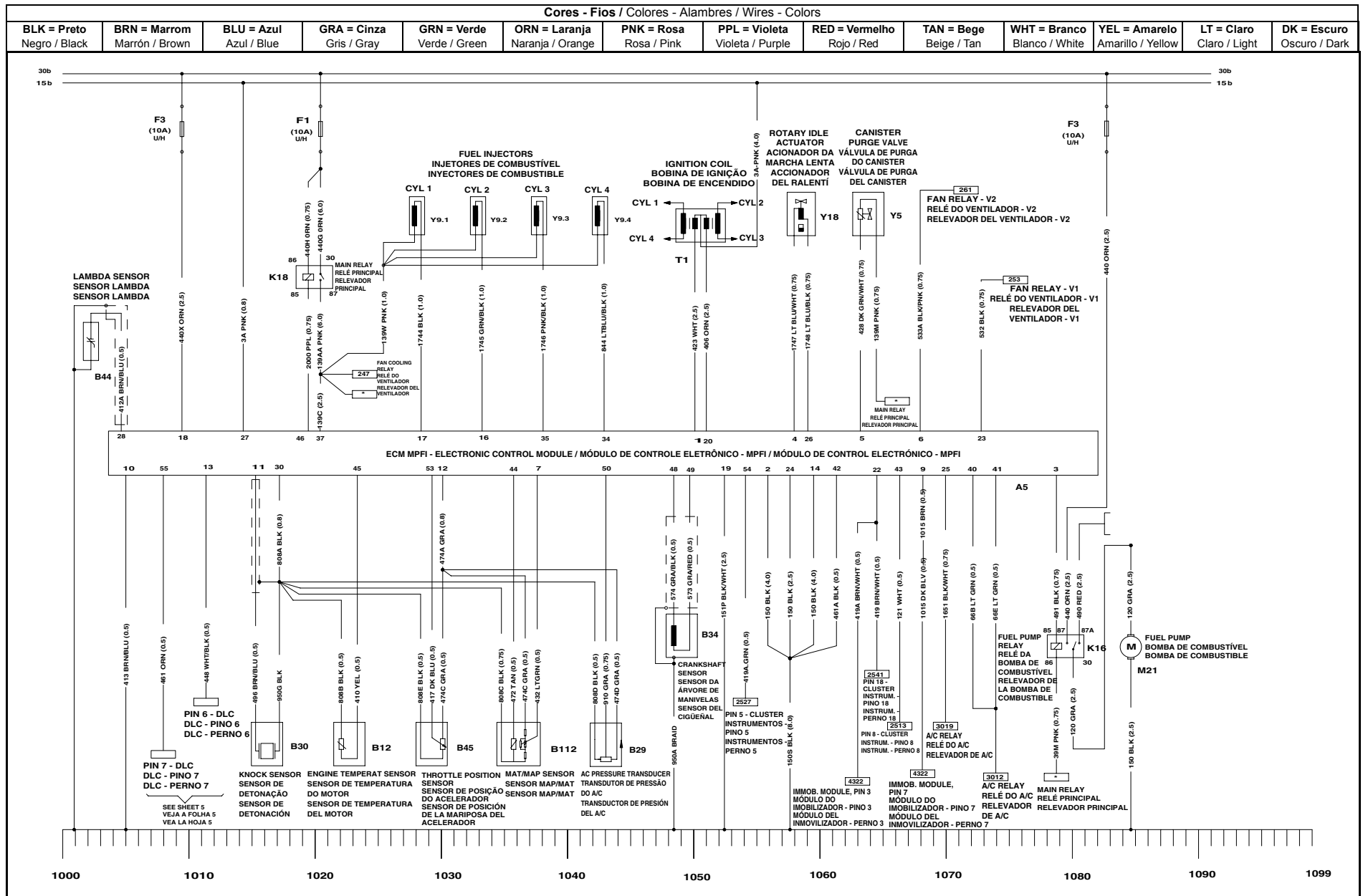

Cores - Fios / Colores - Alambres / Wires - Colors

BLK = Preto Negro / Black	BRN = Marrom Marrón / Brown	BLU = Azul Azul / Blue	GRA = Cinza Gris / Gray	GRN = Verde Verde / Green	ORN = Laranja Naranja / Orange	PNK = Rosa Rosa / Pink	PPL = Violeta Violeta / Purple	RED = Vermelho Rojo / Red	TAN = Bege Beige / Tan	WHT = Branco Blanco / White	YEL = Amarelo Amarillo / Yellow	LT = Claro Claro / Light	DK = Escuro Oscuro / Dark
-------------------------------------	---------------------------------------	----------------------------------	-----------------------------------	-------------------------------------	--	----------------------------------	--	-------------------------------------	----------------------------------	---------------------------------------	---	------------------------------------	-------------------------------------

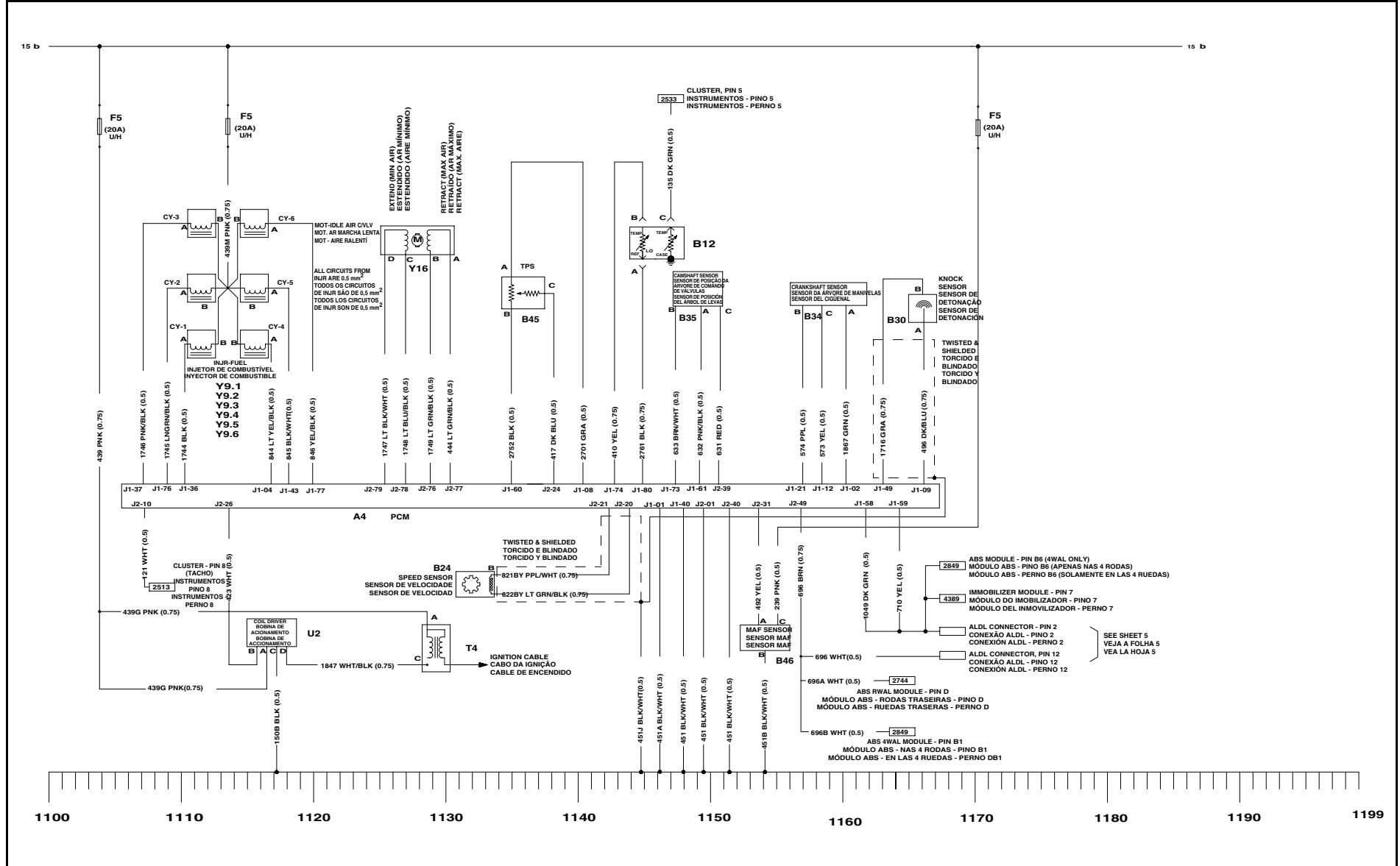

Cores - Fios / Colores - Alambres / Wires - Colors

BLK = Preto Negro / Black	BRN = Marron Marrón / Brown	BLU = Azul Azul / Blue	GRA = Cinza Gris / Gray	GRN = Verde Verde / Green	ORN = Laranja Naranja / Orange	PNK = Rosa Rosa / Pink	PPL = Violeta Violeta / Purple	RED = Vermelho Rojo / Red	TAN = Bege Beige / Tan	WHT = Branco Blanco / White	YEL = Amarelo Amarillo / Yellow	LT = Claro Claro / Light	DK = Escuro Oscuro / Dark
------------------------------	--------------------------------	---------------------------	----------------------------	------------------------------	-----------------------------------	---------------------------	-----------------------------------	------------------------------	---------------------------	--------------------------------	------------------------------------	-----------------------------	------------------------------

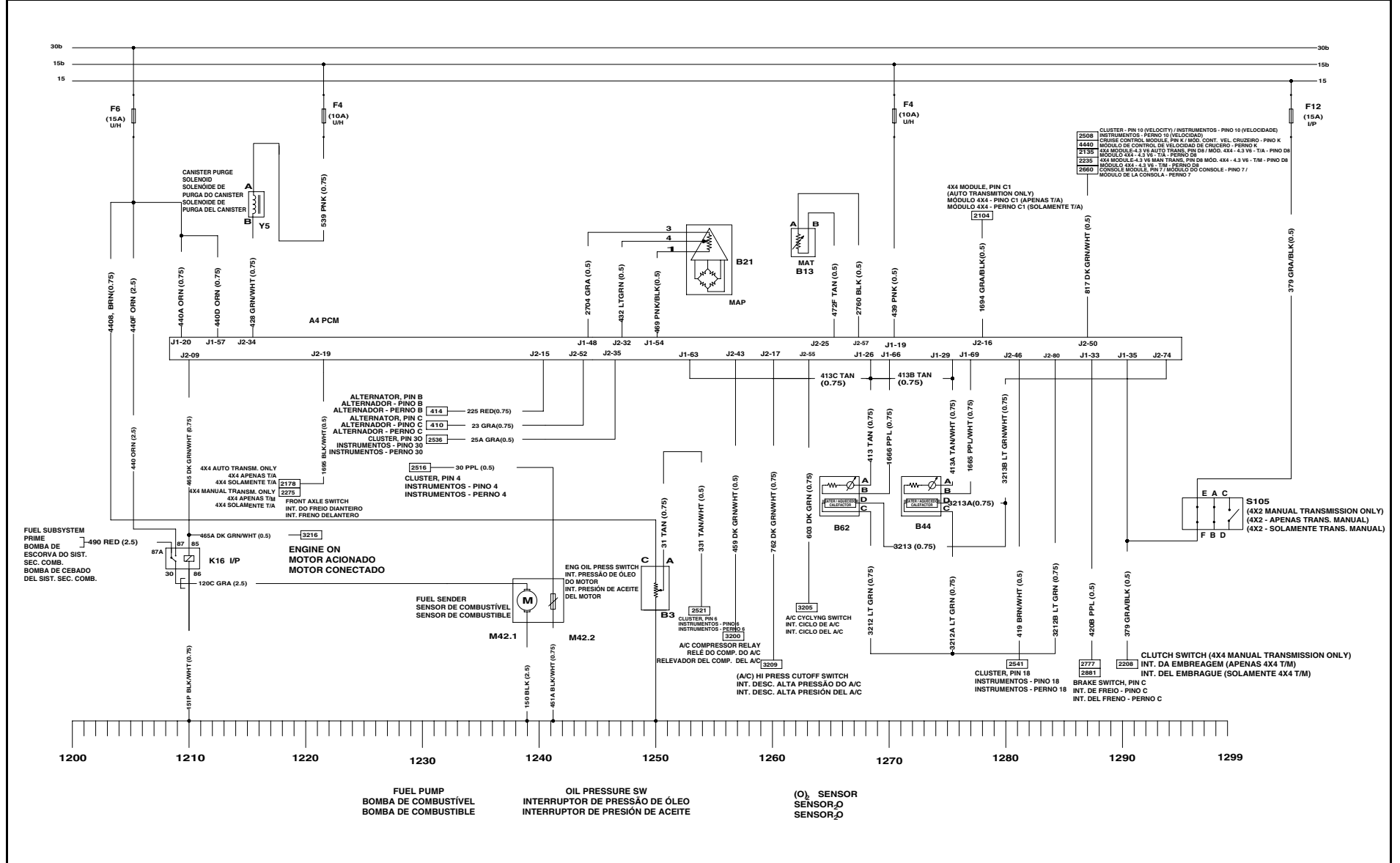

Cores - Fios / Colores - Alambres / Wires - Colors

BLK = Preto Negro / Black	BRN = Marrom Marrón / Brown	BLU = Azul Azul / Blue	GRA = Cinza Gris / Gray	GRN = Verde Verde / Green	ORN = Laranja Naranja / Orange	PNK = Rosa Rosa / Pink	PPL = Violeta Violeta / Purple	RED = Vermelho Rojo / Red	TAN = Bege Beige / Tan	WHT = Branco Blanco / White	YEL = Amarelo Amarillo / Yellow	LT = Claro Claro / Light	DK = Escuro Oscuro / Dark
-------------------------------------	---------------------------------------	----------------------------------	-----------------------------------	-------------------------------------	--	----------------------------------	--	-------------------------------------	----------------------------------	---------------------------------------	---	------------------------------------	-------------------------------------

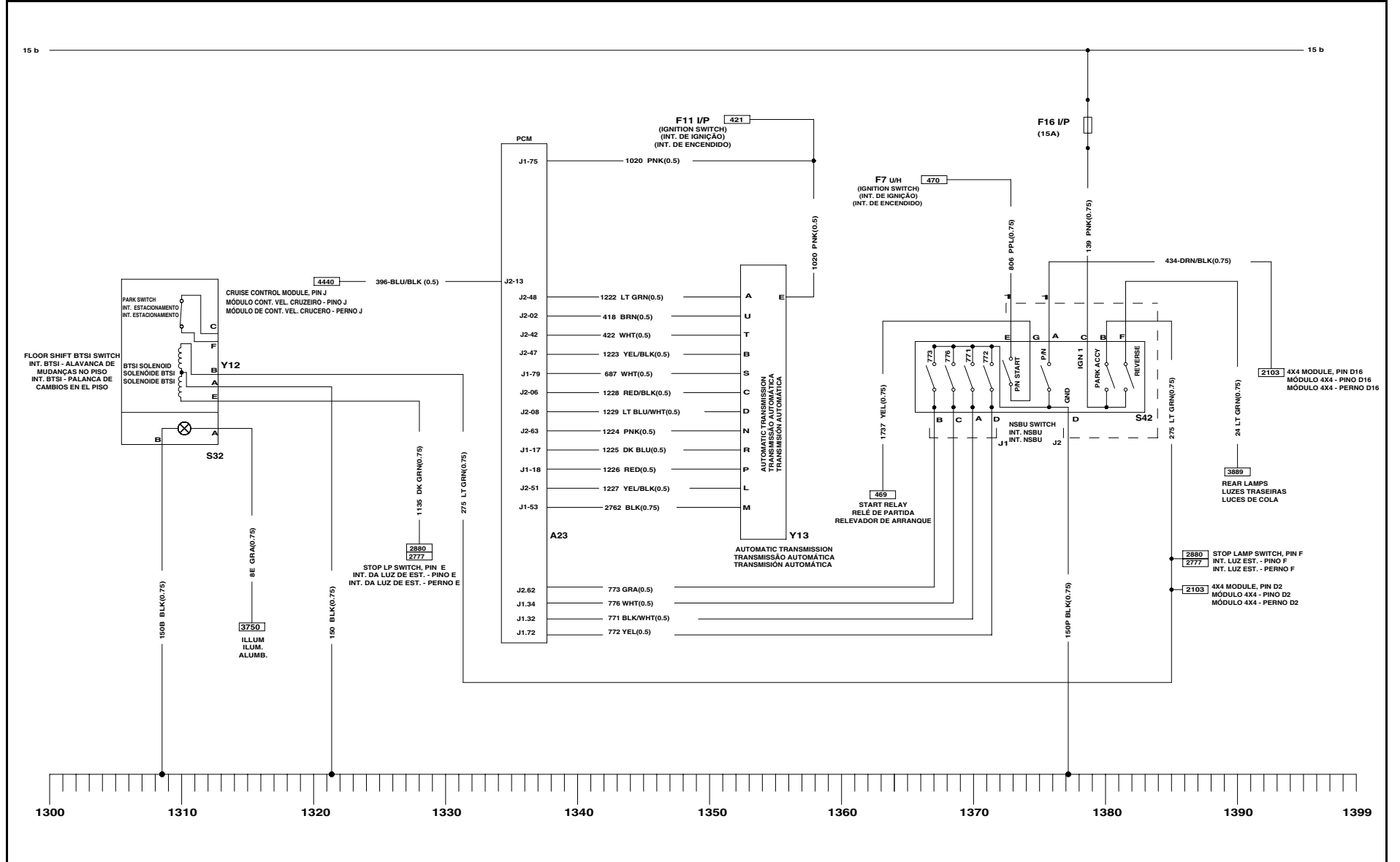

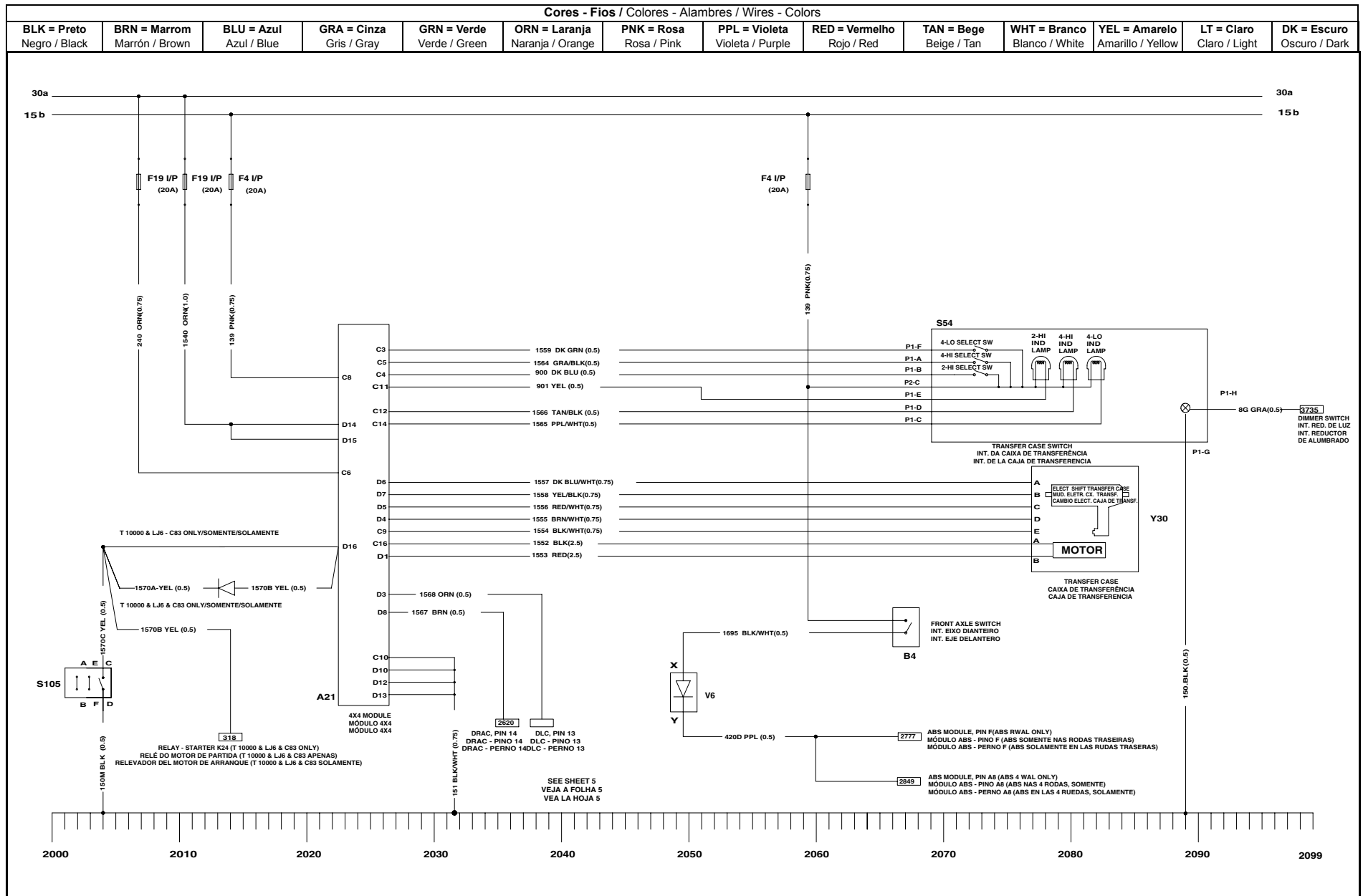

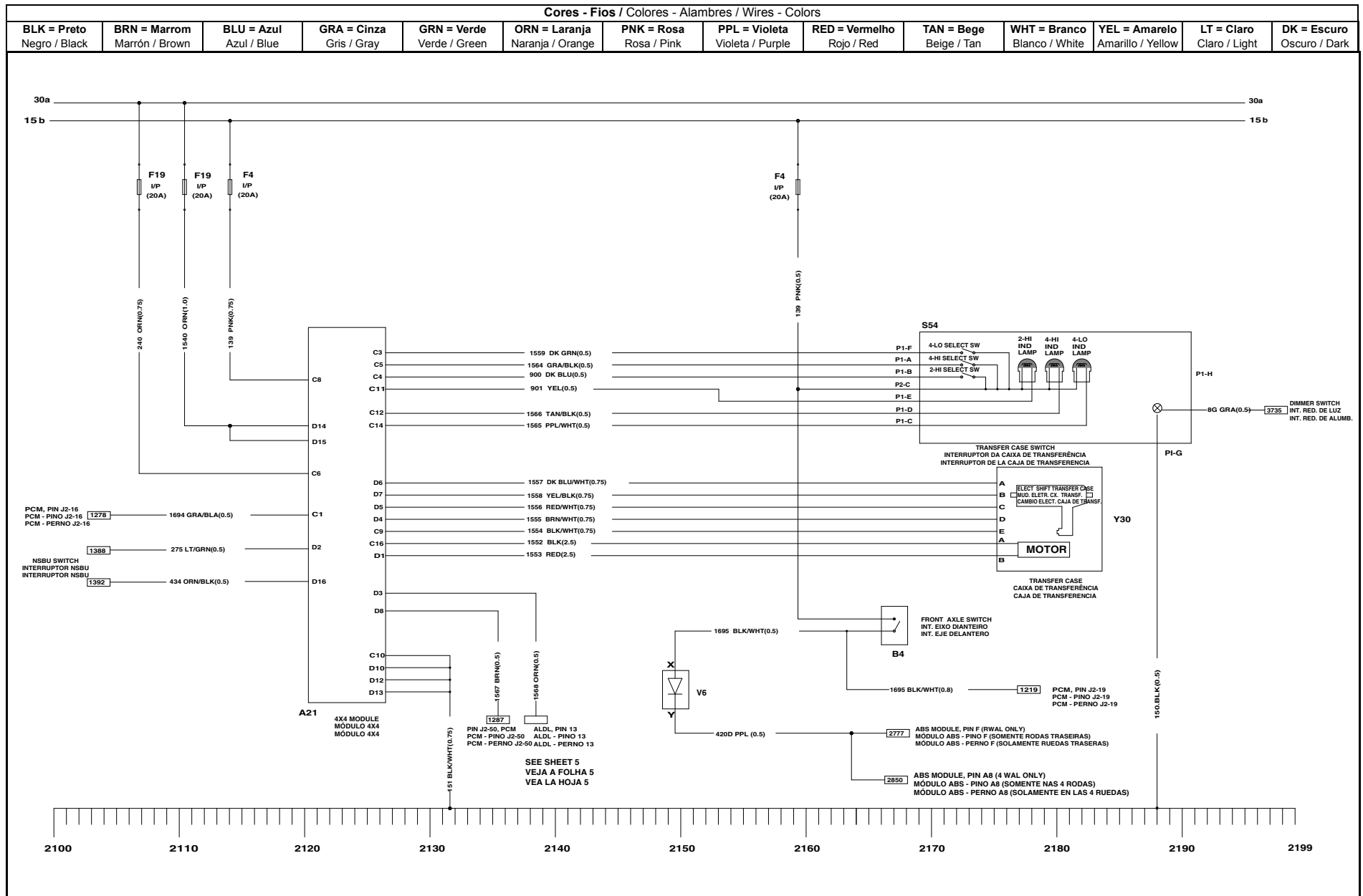

Cores - Fios / Cores - Alambres / Wires - Colors

BLK = Preto Negro / Black	BRN = Marrom Marrón / Brown	BLU = Azul Azul / Blue	GRA = Cinza Gris / Gray	GRN = Verde Verde / Green	ORN = Laranja Naranja / Orange	PNK = Rosa Rosa / Pink	PPL = Violeta Violeta / Purple	RED = Vermelho Rojo / Red	TAN = Bege Beige / Tan	WHT = Branco Blanco / White	YEL = Amarelo Amarillo / Yellow	LT = Claro Claro / Light	DK = Escuro Oscuro / Dark
------------------------------	--------------------------------	---------------------------	----------------------------	------------------------------	-----------------------------------	---------------------------	-----------------------------------	------------------------------	---------------------------	--------------------------------	------------------------------------	-----------------------------	------------------------------

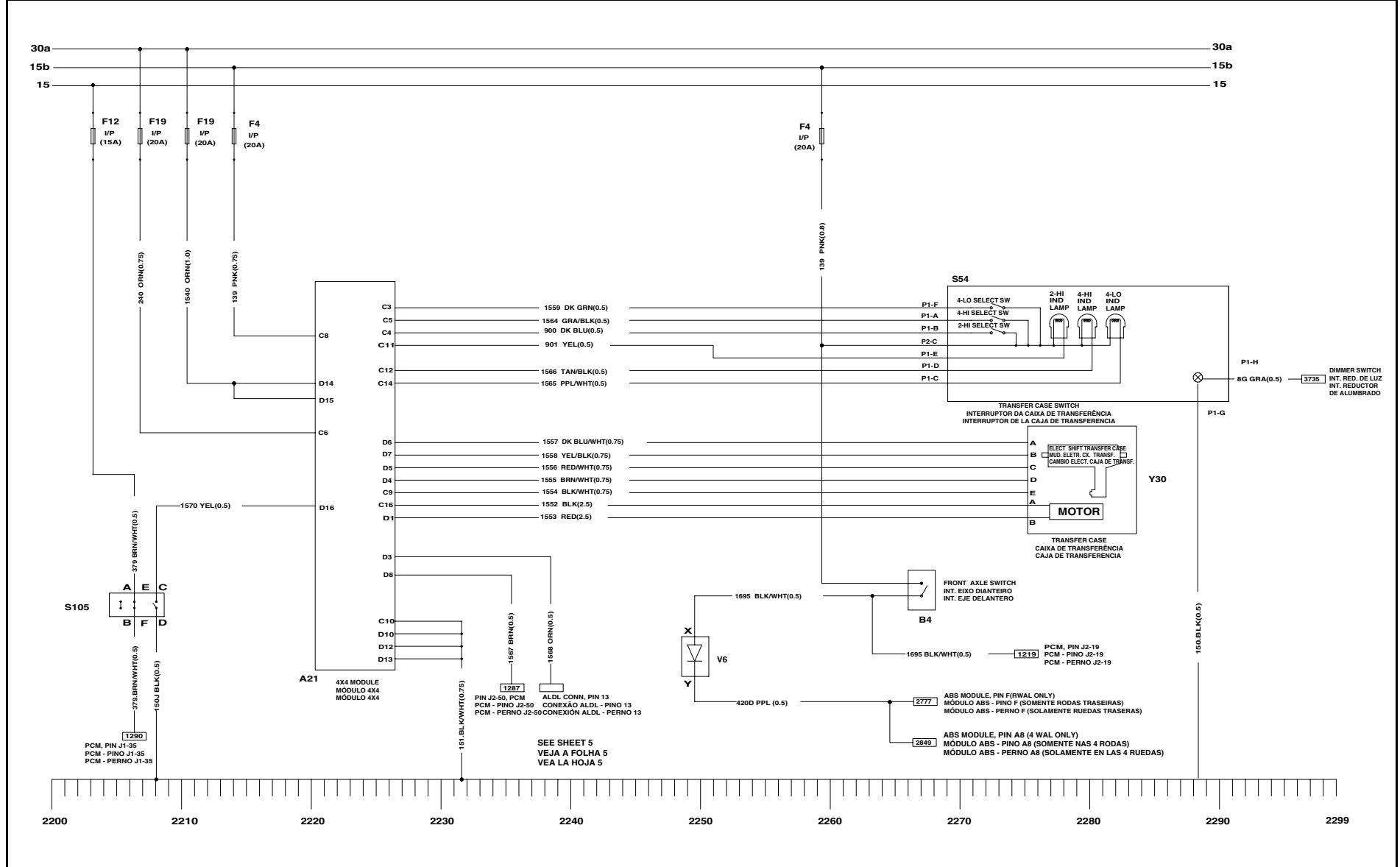

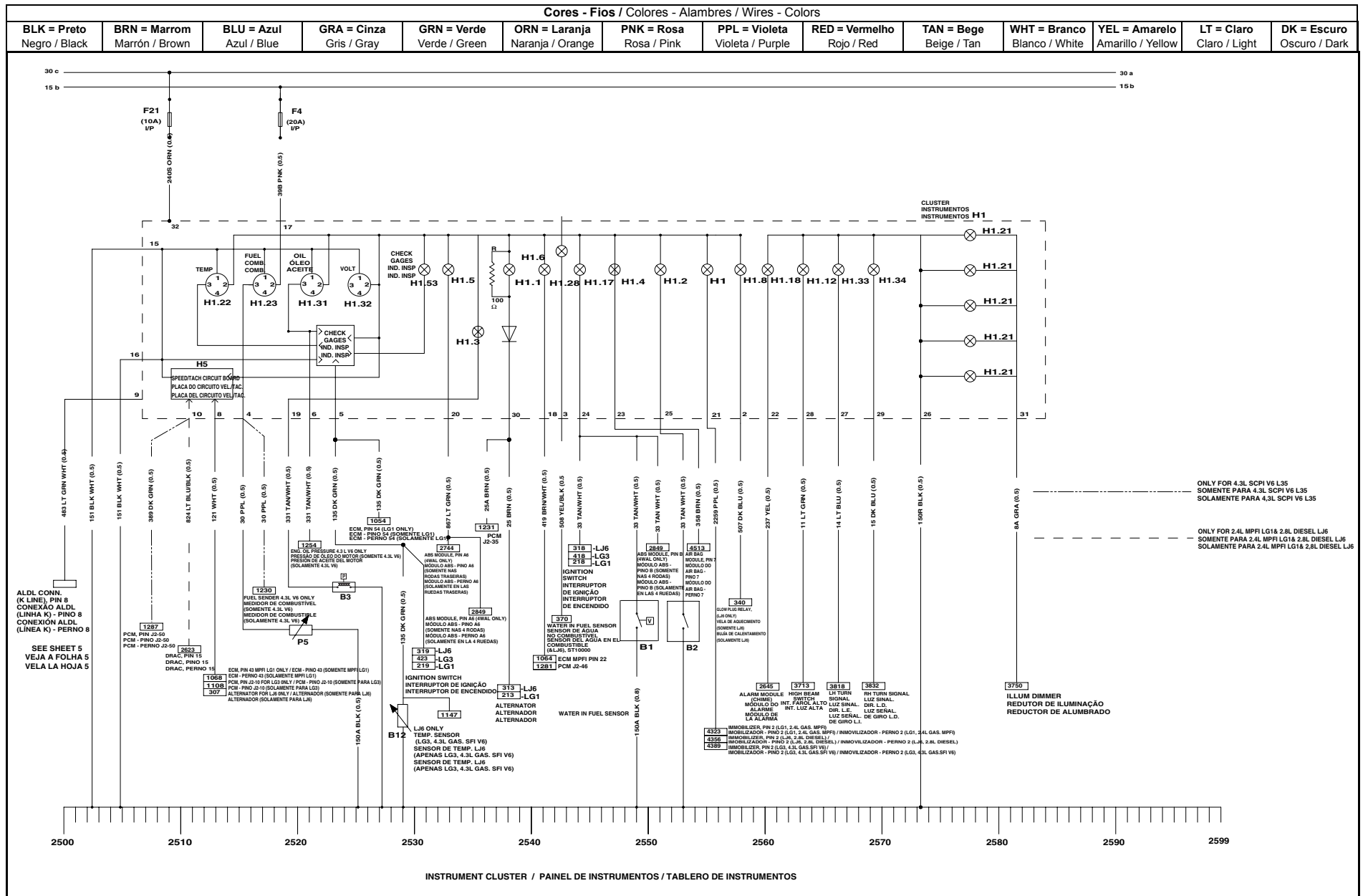

ONLY FOR 4.3L SCPI V6 L35
SOMENTE PARA 4.3L SCPI V6 L35

ONLY FOR 2.4L MPFI LG1& 2.8L DIESEL LJ6
SOMENTE PARA 2.4L MPFI LG1& 2.8L DIESEL LJ6



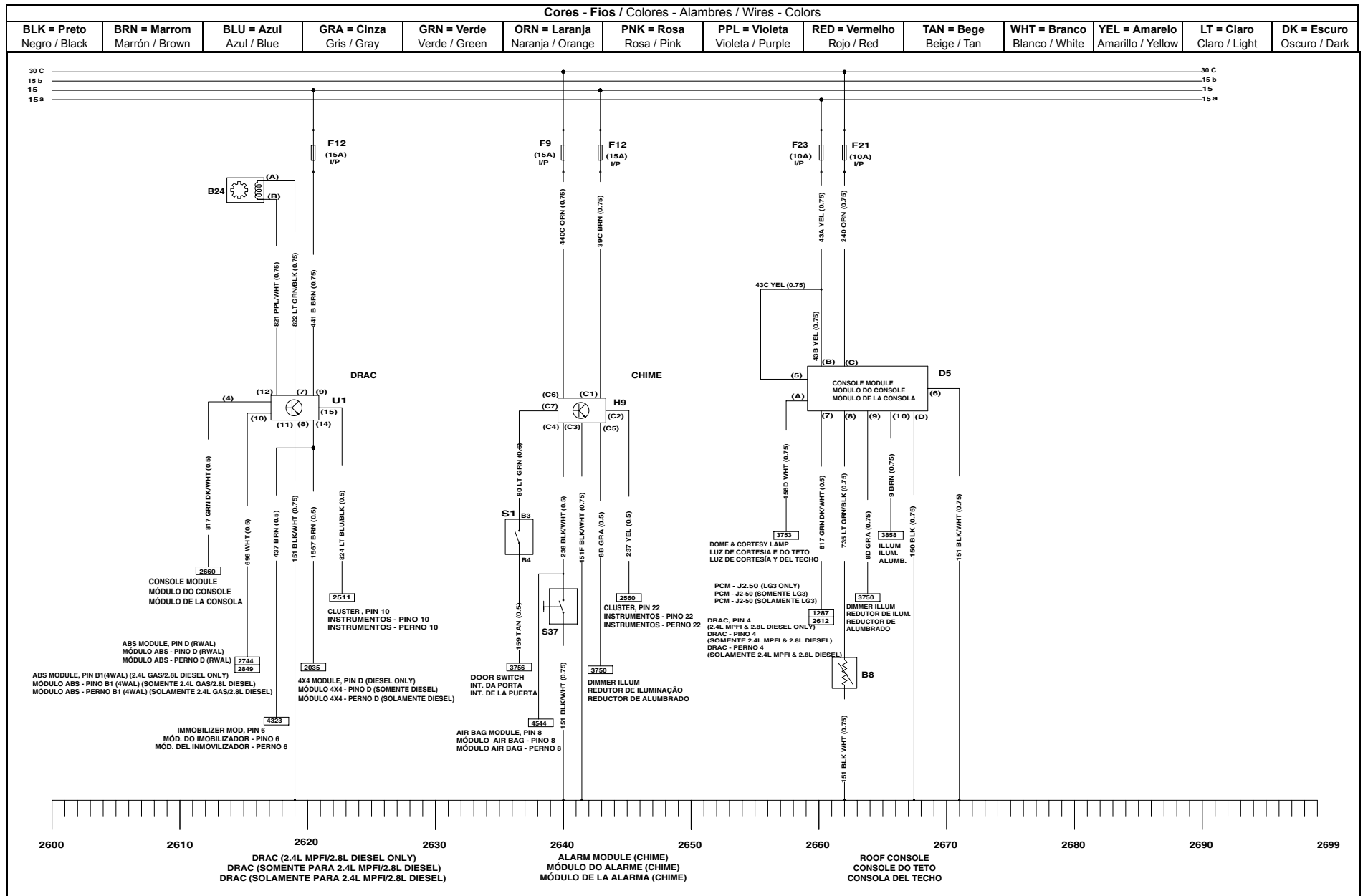

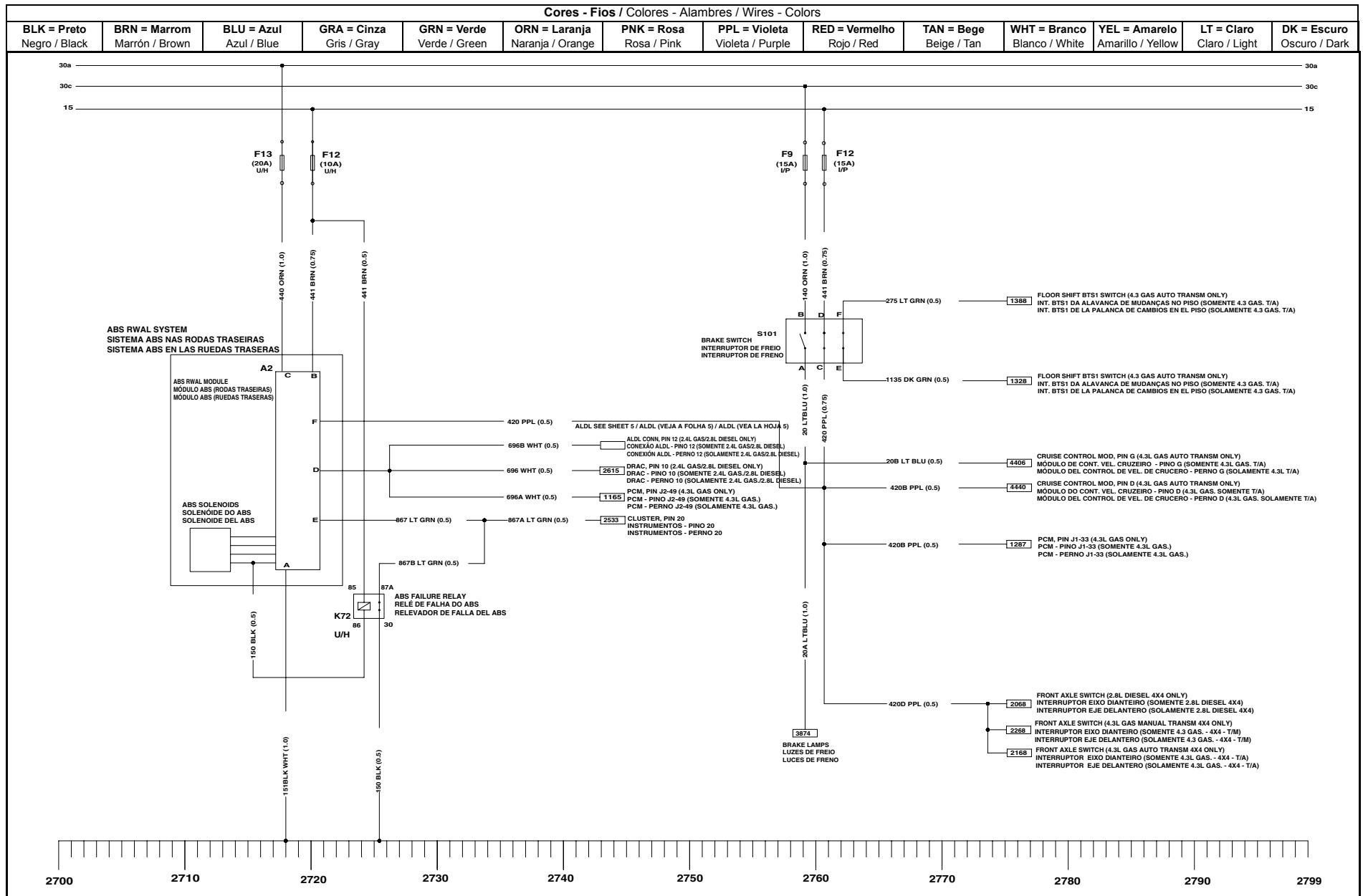

Cores - Fios / Colores - Alambres / Wires - Colors

BLK = Preto Negro / Black	BRN = Marrom Marrón / Brown	BLU = Azul Azul / Blue	GRA = Cinza Gris / Gray	GRN = Verde Verde / Green	ORN = Laranja Naranja / Orange	PNK = Rosa Rosa / Pink	PPL = Violeta Violeta / Purple	RED = Vermelho Rojo / Red	TAN = Bege Beige / Tan	WHT = Branco Blanco / White	YEL = Amarelo Amarillo / Yellow	LT = Claro Claro / Light	DK = Escuro Oscuro / Dark
------------------------------	--------------------------------	---------------------------	----------------------------	------------------------------	-----------------------------------	---------------------------	-----------------------------------	------------------------------	---------------------------	--------------------------------	------------------------------------	-----------------------------	------------------------------

